

Kentico CMS 5.0 E-commerce Guide

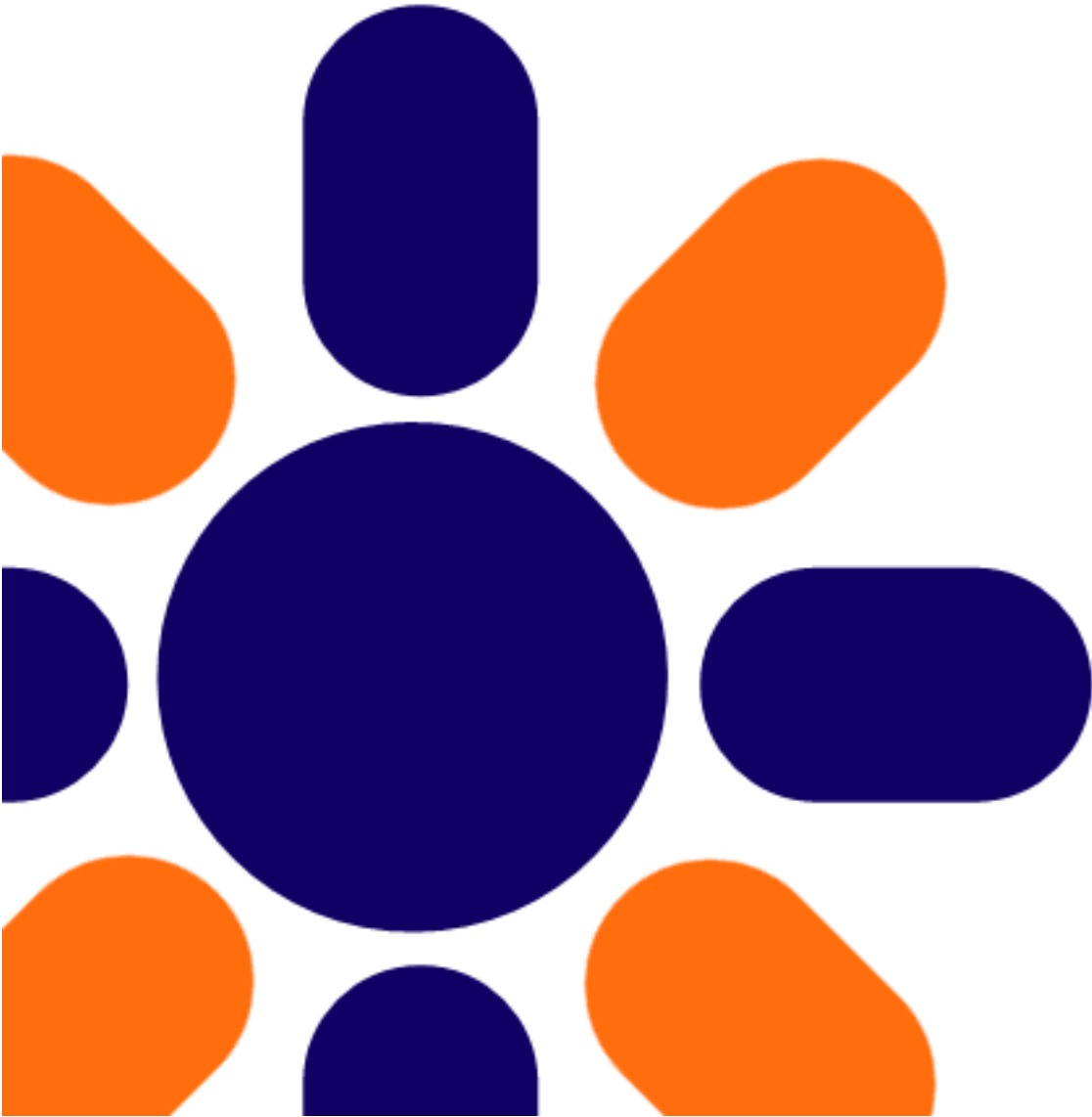

Table of Contents

E-commerce Guide	7
Kentico CMS E-commerce module.....	7
Getting Started	9
Making your first purchase.....	9
Adding new products.....	16
Adding product options.....	20
Customizing product categories.....	25
Adding product to multiple categories.....	29
Displaying featured products.....	33
Sorting and paging products.....	36
Changing company details.....	40
Customizing the product fields	46
Defining a new product type.....	46
Customizing product design.....	53
Adding images to product gallery.....	56
Adding product custom fields.....	64
Customizing web site design	68
Changing the header and menu (master page).....	68
Changing colors using CSS styles.....	77
Integration with your existing Kentico CMS web site	80
Overview.....	80
Web parts.....	81
My account.....	81
Random products.....	83
Shopping cart.....	89
Shopping cart preview.....	91
Similar products by sale.....	93
Top N products by sale.....	95
Wishlist.....	97
Displaying and resizing images.....	99
Overview.....	99
Displaying images.....	99
Storing images.....	102
Resizing images.....	104
Tools.....	108

Overview	108
BizForms	109
Blogs	110
Booking system	110
Content staging	111
Event calendar	112
File import	113
Forums	114
GeoMapping	116
Image Gallery	117
Messaging	118
Newsletters	119
Polls	120
Reporting	121
RSS Feeds	122
User Contributions	122
Web Analytics	123
Web Farm synchronization	124
Adding items to the shopping cart.....	125
Adding items to the wish list.....	130
Displaying product price.....	131
Getting product URL	132
Searching.....	133
Configuration settings	136
Configuration overview	136
Orders.....	137
Customers.....	138
Products.....	142
Product options.....	146
Manufacturers.....	146
Suppliers.....	147
Discount coupons.....	147
Discount levels.....	147
Reports.....	148
Configuration.....	148
Store settings	148
Departments	150
Shipping options	150
Payment methods	150
Tax classes	152
Currencies	152
Exchange rates	153
Order status	153
Public status	153
Internal status	154
Invoice	154

Enabling the e-commerce module.....	156
Security configuration	158
Countries and states.....	159
E-commerce and multi-site configuration.....	159
Mapping document fields to product properties.....	160
Sitemanager settings.....	161
Web.config settings.....	161
Localization settings.....	163
Customizing invoice and e-mail templates.....	166
Using product inventory.....	172
Discounts overview	178
Deleting old shopping carts.....	188
Purchase process and payment gateways	190
Purchase process overview	190
Customizing the purchase process.....	191
Developing custom dialogs for the checkout process.....	195
Payment gateways.....	201
Authorize.NET configuration.....	201
PayPal configuration.....	203
Developing custom payment gateways.....	206
Payment results.....	213
Customer credit.....	215
Developing custom providers	218
Overview	218
Using custom providers.....	219
CustomAddressInfoProvider.....	220
CustomCurrencyInfoProvider.....	221
CustomCustomerInfoProvider.....	222
CustomDepartmentInfoProvider.....	223
CustomDiscountCouponInfoProvider	224
CustomDiscountLevelInfoProvider.....	225
CustomExchangeTableInfoProvider	225
CustomInternalStatusInfoProvider	226
CustomManufacturerInfoProvider.....	227
CustomOptionCategoryInfoProvider	227
CustomOrderInfoProvider.....	228
CustomOrderItemInfoProvider	230
CustomOrderStatusInfoProvider	230

CustomOrderStatusUserInfoProvider	231
CustomPaymentOptionInfoProvider.....	231
CustomPublicStatusInfoProvider	232
CustomShippingOptionInfoProvider	233
CustomShoppingCartInfoProvider	234
CustomShoppingCartItemInfoProvider	235
CustomSKUInfoProvider	236
CustomSupplierInfoProvider.....	237
CustomTaxClassInfoProvider.....	237
CustomVolumeDiscountInfoProvider	239
Using the Product datalist web part.....	239
Figure A: Tax calculation process	241
Figure B: Discount calculation	243
Figure C: Shopping cart price calculation	245
Figure D - Shopping cart retrieval	247

Part

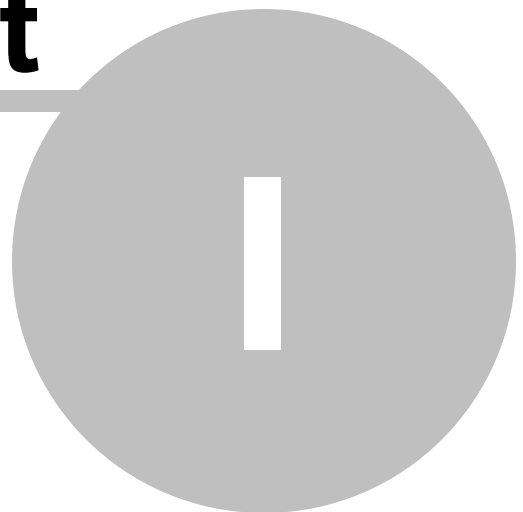

E-commerce Guide

1 E-commerce Guide

1.1 Kentico CMS E-commerce module

The Kentico CMS E-commerce module provides you with a range of out-of-box solutions for your E-business. The task of developing and managing the e-business website, once painfully slow and complex, has been diminished to little more than few clicks.

For customers, the built-in E-commerce module offers a possibility of making purchase online through the integrated shopping cart, checking orders status, subscribing to a newsletter etc.

For site owners, the module offers tools for managing orders, shipping and payment options, products or manufactures lists and much more.

It supports:

- Product management
- Product options management
- Custom product types
- Product image gallery
- Product inventory
- Order management
- Customer management
- Multiple currencies
- Configurable tax calculation based on country and state
- Discount coupons
- Discount levels
- Volume discounts
- Wish list
- Custom providers for alternative shipping and tax calculations
- Custom checkout process
- Built-in payment processors, such as PayPal, Authorize.NET
- Custom payment processors
- Reports and statistics

Part

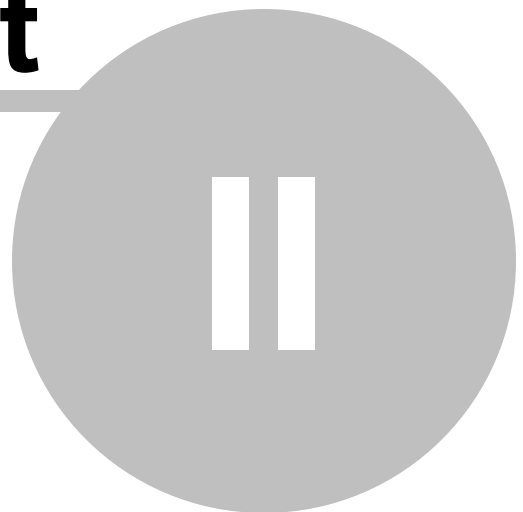

Getting Started

2 Getting Started

2.1 Making your first purchase

For start, you will learn how to buy a product on your web site. This experience will help you in revealing any possible pitfalls which might be awaiting your customers on your web site.

1. Open your favorite internet browser and go to your website. Go to the **Products** tab and click the **Add to cart** button below **Nokia N82**.

The screenshot shows an e-commerce website interface. At the top, there's a navigation bar with 'Home', 'News', 'Products' (highlighted with a red circle), 'How to buy', and 'Company'. Below the navigation bar, there's a 'Products' section with a grid of items. Each item includes an image, a name, a price, and an 'Add to cart' button. The 'Nokia N82' is circled in red, and its 'Add to cart' button is also circled in red. Other products include Canon Digital Rebel XTi, Canon PowerShot A720 IS, Nikon Coolpix S51, Nikon D40, Olympus Stylus FE-230, Pentax K10D, Apple iPhone, LG KG 800, Motorola V3 Razr, Nokia 6300, and Samsung SCH i620. The page also features a search bar, a shopping cart icon, and a 'Sign In' button. A footer at the bottom indicates 'Powered by KENTICO'.

Product Name	Price	Action
Canon Digital Rebel XTi	\$ 597.00	Add to cart
Canon PowerShot A720 IS	\$ 195.00	Add to cart
Nikon Coolpix S51	\$ 189.00	Add to cart
Nikon D40	\$ 490.00	Add to cart
Olympus Stylus FE-230	\$ 159.00	Add to cart
Pentax K10D	\$ 804.00	Add to cart
Apple iPhone	\$ 499.00	Add to cart
LG KG 800	\$ 190.00	Add to cart
Motorola V3 Razr	\$ 130.00	Add to cart
Nokia 6300	\$ 129.00	Add to cart
Nokia N82	\$ 490.00	Add to cart
Samsung SCH i620	\$ 650.00	Add to cart

2. Now specify your order. Choose **Black** as **Color** and enter 4 into the text box next the **Add to cart** button. You are about to add 4 pieces of Nokia N82 in black color to your shopping cart. Click **Add to cart**.

Nokia N82



Parameters:

Width:	112
Height:	50
Weight(g):	114
Display type:	TFT 16M colors
Display resolution:	240 x 320
Bluetooth:	yes
IrDA:	no
GPRS:	yes
EDGE:	yes
HSCSD:	yes
3G:	yes
Wi-Fi:	yes
Java:	yes
Built-in camera:	yes
MP3 player:	yes

Our price: \$ 490.00

Nokia N82 - Color

- Silver (+ \$ 0.00)
 Black (+ \$ 10.00)

 Add to wishlist

4

 Add to cart

3. You have been redirected to the shopping cart. In the **Step 1**, click the first **Price detail** button.

Step 1 of 6 - Add some products to the shopping cart



Shopping cart

Currency: U.S. Dollar

Remove	Product name	Units	Unit price	Unit discount	Tax	Subtotal
<input type="checkbox"/>	Nokia N82	4	490.00	29.40	184.24	2026.64
	- Black	4	10.00	0.00	4.00	44.00

If you have a coupon code, please enter it here:

Total shipping: \$ 0.00
Total price: \$ 2070.64

4. Now you can see detailed description of the price of your order including the volume discount and taxes. Close the window.

Shopping cart - Product price detail -- Webpage Dialog

Product price detail

Nokia N82

Unit price without tax \$ 490.00

Discounts	Per unit	
- Volume discount for minimal amount of 3 units	-6%	-\$ 29.40
Price after discount	\$ 460.60	

Taxes	Per unit	
- Sales tax	+10%	+\$ 46.06
Price with tax	\$ 506.66	

Units 4

Total price \$ 2026.64

http://petrvo3/CM531/CM5Ecommerce/ShoppingCart/ShoppingCartSKUPr Local intranet

5. Now click the **Check out** button at the bottom.

Step 1 of 6 - Add some products to the shopping cart



Shopping cart

Currency: U.S. Dollar

Remove	Product name	Units	Unit price	Unit discount	Tax	Subtotal
<input type="checkbox"/>	Nokia N82	<input type="text" value="4"/>	490.00	29.40	184.24	2026.64
	- Black	4	10.00	0.00	4.00	44.00

If you have a coupon code, please enter it here:

Total shipping: \$ 0.00
Total price: **\$ 2070.64**

6. In the **Step 2**, choose **Create a new account**. Now enter information for your new account:

- **First name:** David
- **Last name:** Simons
- **E-mail(user name):** DavidSimons@gmail.com

Click **Next**.

Step 2 of 6 - Registration check



User registration

Sign in using your existing account

E-mail (user name):

Password:

[Forgotten password](#)

Create a new account

First name:

Last name:

E-mail (user name):

Company account:

Password:

Confirm password:

Continue as anonymous customer

First name:

Last name:

E-mail:

Company (optional):

7. In the **Step 3**, enter the new billing address:

- **Name (Company or personal):** Development Soft
- **Address Line:** 1020 Blueberry Ln.
- **City:** Tucson
- **ZIP:** 85754

Please note that you can choose the shipping or company address different from the billing address by checking one of the check boxes at the bottom. For now, just click **Next**, though.

Step 3 of 6 - Select billing and shipping address



Billing address

Billing address: (new)

Name (company or personal):

Address lines:

City:

ZIP:

Country:

Phone number:

My shipping address is different from the billing address.

My company address is different from the billing address

8. In the **Step 4**, you can choose the shipping and payment method for your delivery. Click **Next**.

Step 4 of 6 - Select payment and shipping methods



Shipping and payment methods

Shipping:

Payment:

9. In the **Step 5**, make sure that you all the order information are correct. If everything looks right, click **Order now**.

Step 5 of 6 - Order preview

Order preview

Billing address

Development Soft
1020 Blueberry Ln.
Tucson
85754
USA, Alaska

Shipping address

Development Soft
1020 Blueberry Ln.
Tucson
85754
USA, Alaska

Company address

Development Soft
1020 Blueberry Ln.
Tucson
85754
USA, Alaska

Payment method: Cash on delivery **Shipping option:** DHL

Product name	Units	Unit price	Unit discount	Tax	Subtotal
Nokia N82	4	490.00	29.40	184.24	2026.64
- Black	4	10.00	0.00	4.00	44.00

Shipping: \$ 8.00

Total price: \$ 2078.64

Tax name	Tax summary
Sales tax	188.24

Order note:

Back

Order now

If everything went well, you can see the confirmation text.

Thank you for your order

We have received your order and we will process it within 24 hours.

*This is a sample page showing the confirmation text. You can configure your payment methods in **Tools -> E-commerce -> Configuration -> Payment methods** so that the user is redirected to some third-party on-line payment gateway, such as Authorize.NET, PayPal and others.*

Congratulations, you've just made your first order.

© 2009 Kentico Software

2.2 Adding new products

1. Sign in to CMS Desk.
2. Go to CMS Desk -> Products -> PDAs.

The screenshot shows the Kentico CMS 5.0 E-commerce Guide interface. The top navigation bar includes 'CMS Desk', 'Content', 'My Desk', 'Tools', and 'Administration'. The user is logged in as 'Global Administrator' on the 'Ecommerce site'. The left sidebar shows a tree view of the site structure, with 'PDAs' highlighted under 'Products'. The main content area displays the 'Products / PDAs' page, featuring a search bar, navigation tabs, and a list of products including 'Asus A639', 'HP IPAQ 114', and 'HP IPAQ hx2795 Pocket PC'. The 'New' button in the document action toolbar is circled in red.



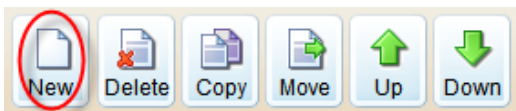





















3. Click **New** at the document action toolbar.



4. Choose the **Product - PDA** document type.

 **New document**

Please select new document type:

-  [Article](#)
-  [Blog](#)
-  [Cell phone](#)
-  [Event](#)
-  [Event \(booking system\)](#)
-  [FAQ](#)
-  [File](#)
-  [Folder](#)
-  [Job opening](#)
-  [Knowledge base article](#)
-  [Laptop](#)
-  [News](#)
-  [Office](#)
-  [Page \(menu item\)](#)
-  [PDA](#)
-  [Press release](#)
-  [Product](#)
-  [Product - Camera](#)
-  [Product - Cell phone](#)
-  [Product - Computer](#)
-  [Product - Laptop](#)
-  [Product - MP3 & MediaPlayer](#)
-  [Product - PDA](#)
-  [Simple article](#)

5. Adding new product is two step process. Firstly, you enter attributes for the new document. Secondly, you enter attributes for the new product. For explanation about the difference between these two please see the box at the end of the [Products](#) chapter. Now enter attributes for the new document:

- **Name:** HTC Touch Cruise
- **Battery:** Lithium ion
- **Display type:** TFT LCD
- **Resolution:** 240×320
- **RAM(MB):** 128
- **Processor(MHZ):** 400
- **Weight(g):** 200
- **Operating system:** Microsoft Windows Mobile 6

Now enter attributes for product itself. Check the **Create a new product** checkbox and enter 900 as **Price**. Click **Save** at the top to save your new product.

Products ▶ PDAs

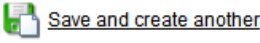
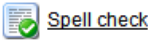
 Save  Save and create another  Spell check

Name:

Battery:

Display type:

Resolution:

RAM (MB):

Processor (MHz):

Weight(g):

Operating system:

Publish from:  Now

Publish to:  Now

Create a new product

Price:

Product image URL: Upload:

The new camera has been added to your product list.

■ HTC Touch Cruise



No image

Parameters:

Battery:	Lithium ion
Display type:	TFT LCD
Resolution:	240×320
RAM (MB):	128
Processor (MHz):	400
Weight(g):	200
Operating system:	Microsoft Windows Mobile 6

Our price: \$ 900.00

 Add to wishlist

1

 Add to cart



Creating product from existing document

This chapter describes how to create a new product while creating new document. In **Kentico CMS**, you can also choose to create product from an already existing document, though.

All you have to do is to select a given document in the content tree and switch to the **Product** tab. Then check **Mark document as product**. By choosing **Select an existing product**, you can use an existing product as a template for a new product. By choosing **Create a new product**, you can create a new one from scratch.

2.3 Adding product options

In Kentico CMS, product options can be defined for each product. With specified product option for the given product, you can offer your customers greater variability in choosing the right product and boost your sales as well. In this chapter, you will learn how to set up a new product option for the product which hasn't had any product option specified so far.

1. Go to **CMS Desk -> Tools -> E-commerce -> Product options**.

The screenshot shows the Kentico CMS interface. The 'Tools' menu is open, and 'E-commerce' is selected. The 'Product options' sub-menu is also open, showing a list of existing options. The 'New option category' button is highlighted.

Actions	Name	Selection type	Enabled
	Cell phones accessories	Checkboxes - horizontal	True
	Creative Zen Stone - Color	Dropdown list	True
	iPod Shuffle - Colors	Radiobuttons - vertical	True
	Nokia 6300 - Color	Dropdown list	True
	Nokia N82 - Color	Radiobuttons - vertical	True
	Notebooks - AMD CPU	Dropdown list	True
	Notebooks - DDR2 modules	Dropdown list	True
	Notebooks - HDD	Dropdown list	True
	Notebooks - Intel CPU	Dropdown list	True
	Operating systems	Dropdown list	True
	PCs - Cases	Dropdown list	True
	PCs - CD/DVD ROM/RW, BlueRay	Dropdown list	True
	PCs - CPU AMD	Dropdown list	True
	PCs - CPU Intel	Dropdown list	True
	PCs - Graphics card	Dropdown list	True
	PCs - HDD	Dropdown list	True
	PCs - Memory modules	Dropdown list	True
	PCs - Monitors	Dropdown list	True
	PCs - Motherboards	Dropdown list	True

2. Click **New option category**.
3. Enter *Color* into the **Category name** text box and click **Ok**.

New option category

[Option categories](#) ▶ New option category

Category name:

4. Select **Checkboxes in vertical layout** from the **Selection type** drop-down menu.

Option category properties

[Option categories](#) ▶ Color

General Options

The changes were saved.

Category name:

Selection type:

Default option(s): (No product options defined)

Description:

Default record text:



Enabled:

5. Switch to the **Options** tab and click **New product option**.

Option category properties

[Option categories](#) ▶ Color

General **Options**

 [New product option](#)  [Sort A-Z](#)

6. Enter *Black* into the **Product name** text box, *0* into the **Price** text box and choose **General** from the **Department** drop-down menu. Then click **Ok** at the bottom.

Option category properties

[Option categories](#) ▶ Color

[Product options](#) ▶ New product option 

General **Options**

Product name:

Product number:

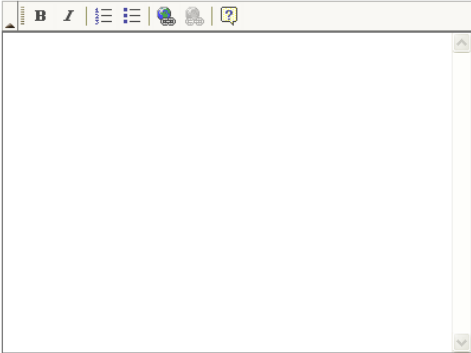
Description: 

Price:

Enabled:

Department:

Manufacturer:

Supplier:

Public status:

Internal status:

Availability (days):

Product image URL: Upload:

Package

Package weight:

Package height:

Package width:

Package depth:

Inventory

Available items:

Sell only if items are available:

6. Click the **Options** tab and then click **New product option** again.

7. Now enter *Silver* as **Product name**, *10* as **Price** and choose **General** as **Department**. Then click **Ok**.

8. Click the **Options** tab and **New product option** again.

9. Enter *Green* as **Product name**, *-10* as **Price** and choose **General** as **Department**. Then click **Ok**.

10. Now switch to **Products** tab and click the **Edit** button next to the **Apple MacBook Air** product name.

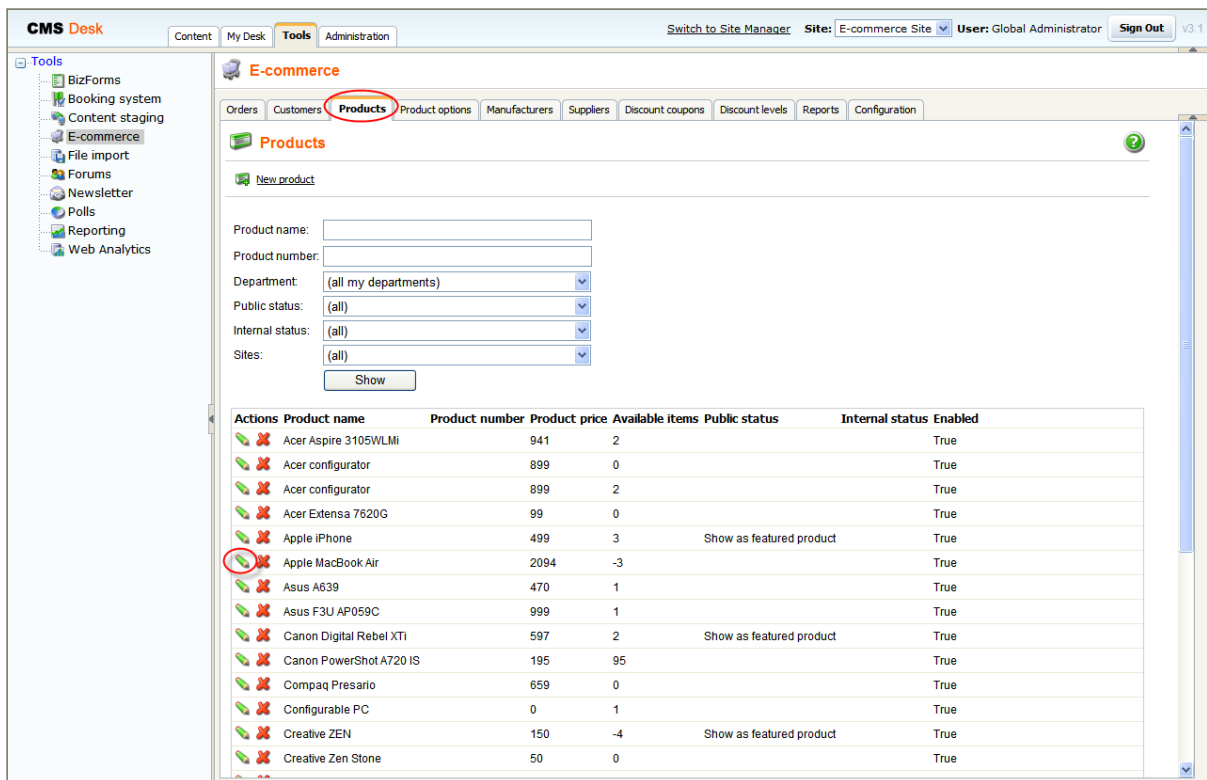

The screenshot shows the CMS Desk interface with the E-commerce section selected. The 'Products' tab is active, and the 'Apple MacBook Air' product is highlighted in the list. The 'Edit' button next to it is circled in red.

Actions	Product name	Product number	Product price	Available items	Public status	Internal status	Enabled
	Acer Aspire 3105WLMi	941	2				True
	Acer configurator	899	0				True
	Acer configurator	899	2				True
	Acer Extensa 7620G	99	0				True
	Apple iPhone	499	3		Show as featured product		True
	Apple MacBook Air	2094	-3				True
	Asus A639	470	1				True
	Asus F3U AP059C	999	1				True
	Canon Digital Rebel XTi	597	2		Show as featured product		True
	Canon PowerShot A720 IS	195	95				True
	Compaq Presario	659	0				True
	Configurable PC	0	1				True
	Creative ZEN	150	-4		Show as featured product		True
	Creative Zen Stone	50	0				True

11. Switch to the **Options** tab, check the **Select** checkbox next to the **Color** option category and click **Save**.

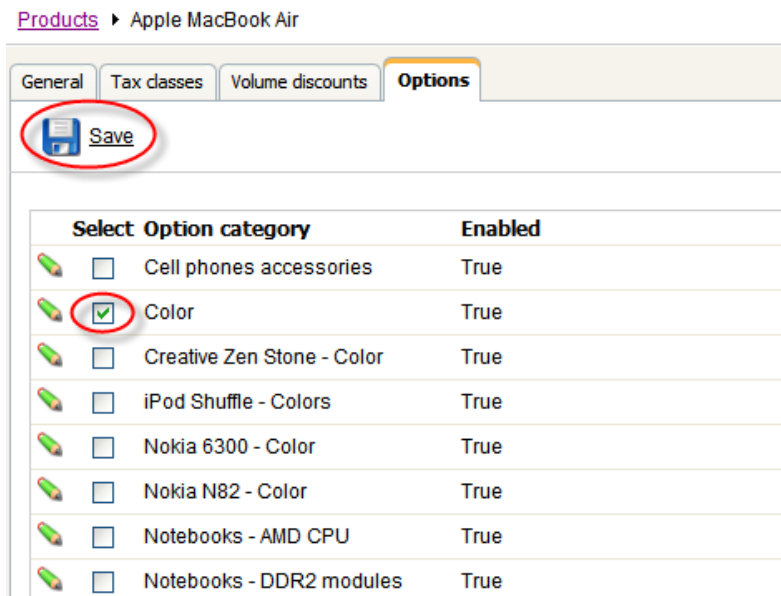

The screenshot shows the CMS Desk interface with the E-commerce section selected. The 'Products' tab is active, and the 'Apple MacBook Air' product is selected. The 'Options' tab is active, and the 'Color' option category is checked. The 'Save' button is circled in red.

[Products](#) ▶ Apple MacBook Air

General Tax classes Volume discounts **Options**

Save

Select	Option category	Enabled
<input type="checkbox"/>	Cell phones accessories	True
<input checked="" type="checkbox"/>	Color	True
<input type="checkbox"/>	Creative Zen Stone - Color	True
<input type="checkbox"/>	iPod Shuffle - Colors	True
<input type="checkbox"/>	Nokia 6300 - Color	True
<input type="checkbox"/>	Nokia N82 - Color	True
<input type="checkbox"/>	Notebooks - AMD CPU	True
<input type="checkbox"/>	Notebooks - DDR2 modules	True

The new product option has been added to the **Apple MacBook Air** product.

The screenshot displays the product detail page for the Apple MacBook Air. The page layout includes a header with navigation links (Home, News, Products, How to buy, Company) and a shopping cart notification. The main content area features the product name, a small image of the laptop, and a list of parameters. Below the parameters, the current price is shown as \$2094.00. A color selection section offers three options: Black (+ \$ 0.00), Silver (+ \$ 10.00), and Green (- \$ 10.00). The page also includes a sidebar with a product category tree, a poll, and quick links.

E-commerce starter site

Sign in to [CMS Desk](#). Sign in to [CMS Site Manager](#). The default account is administrator with blank password.

Shopping cart | My account | My wishlist
Your shopping cart is empty

Search Home News Products How to buy Company Sign In

Products / Notebooks / 13" / Apple MacBook Air

Apple MacBook Air

Parameters:

Processor type: Intel Core 2 Duo processor with 4MB on-chip shared L2
 Display type: 13.3-inch widescreen TFT
 Resolution: 1280x800
 Graphics card: Intel GMA X3100 144MB
 Memory type: 667MHz DDR2 SDRAM onboard
 Memory size: 2048
 Optical drive: 80GB 4200-rpm Parallel ATA
 Hard Drive: 80GB 4200-rpm Parallel ATA
 Wireless LAN: yes
 Bluetooth: yes
 Infrared: no
 Battery type: Integrated 37-watt-hour lithium-polymer battery
 Weight(g): 1.36
 Operating system: Mac OS
 Accessories:

Our price: \$ 2094.00

Color

Black (+ \$ 0.00)
 Silver (+ \$ 10.00)
 Green (- \$ 10.00)

Add to wishlist 1 Add to cart

Random products

Toshiba Satellite Pro \$ 1499.00
 Creative Zen Stone \$ 50.00
 Acer Extensa 7620G \$ 99.00
 Asus A639 \$ 470.00

Latest news

2/13/2008
 Dear customers, our shop now supports payments through PayPal. You can use this feature from this day.

2/13/2008
 Dear customers, our company has become Apple partner so you can buy Apple's great products at our shop.

Newsletter subscription

For information how to display product options in product detail please refer to the [Adding items to the shopping cart](#) chapter.

2.4 Customizing product categories

1. Go to **CMS Desk** -> **Content** and choose **Products** in the content tree.

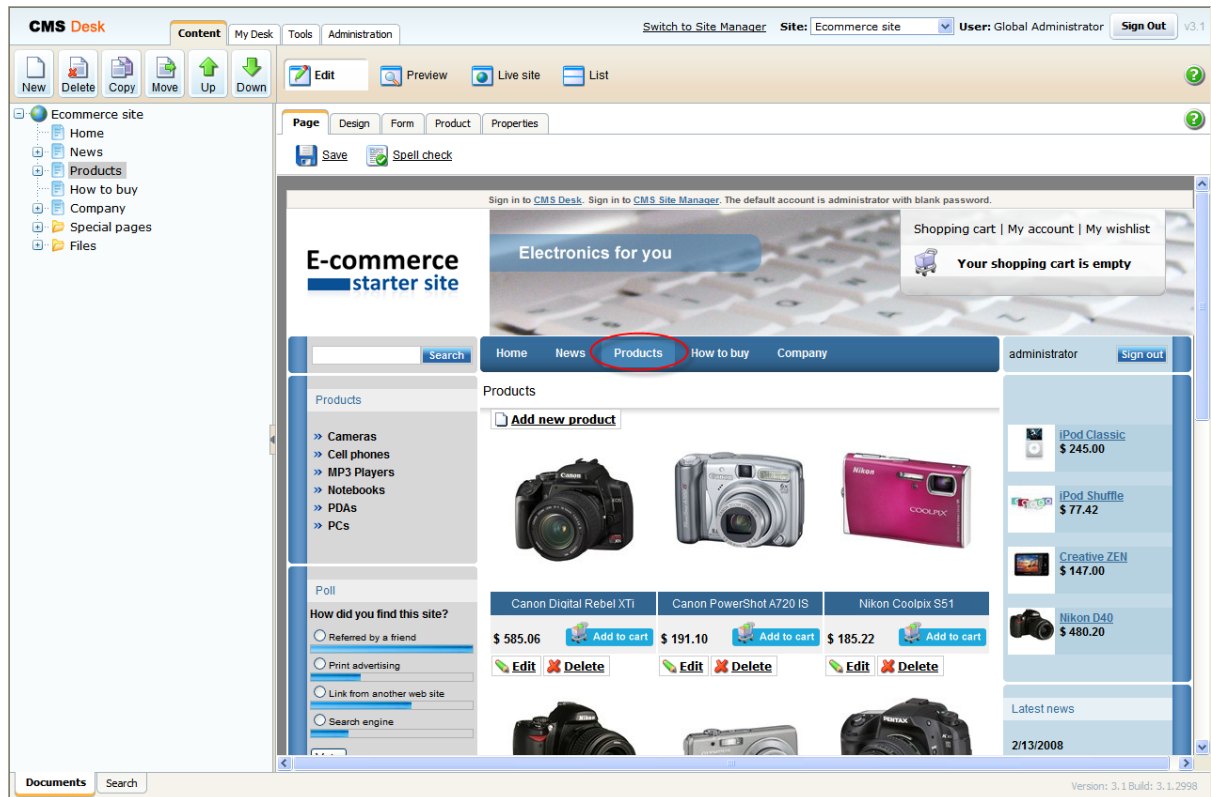



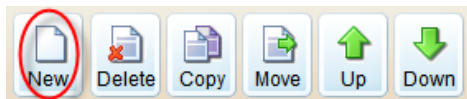









2. Click **New** at the document action toolbar.



3. Choose the **Page(menu item)** document type.

 **New document**

Please select new document type:

-  [Article](#)
-  [Blog](#)
-  [Cell phone](#)
-  [Event](#)
-  [Event \(booking system\)](#)
-  [FAQ](#)
-  [File](#)
-  [Folder](#)
-  [Job opening](#)
-  [Knowledge base article](#)
-  [Laptop](#)
-  [News](#)
-  [Office](#)
-  [Page \(menu item\)](#)
-  [PDA](#)
-  [Press release](#)
-  [Product](#)
-  [Product - Camera](#)
-  [Product - Cell phone](#)
-  [Product - Computer](#)
-  [Product - Laptop](#)
-  [Product - MP3 & MediaPlayer](#)
-  [Product - PDA](#)
-  [Simple article](#)

4. Enter *Plasma TVs* as the **Page name**, make sure the **Use page template** radio button is selected and choose **E-commerce -> Ecommerce - Products** template. Click **Save**.

Products

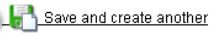
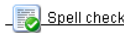
 Save  Save and create another  Spell check

Page name: Plasma TVs

Use page template Inherit from parent page Create a blank page

Categories

- Articles
- Blogs
- E-commerce
- Ecommerce site**
- Events
- FAQs
- Forums
- General
- Home pages
- Images
- Job openings
- Knowledge base
- Master templates
- Membership and security
- News
- Newsletter
- Offices
- Press releases
- Products
- Templates with editable regions
- Wiki

Ecommerce - New registration

Ecommerce - News list

Products

Ecommerce - Print

Ecommerce - Products

Ecommerce - Search page

Ecommerce - Shopping cart

Ecommerce - Products

5. Your new page has been appended to the **Products** page. Now use the **Down** button at the document action toolbar to move it to the bottom of the section.

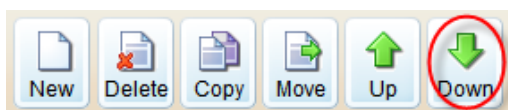

That's how you add a new category to your **Products** page.

The screenshot displays the Kentico CMS 5.0 E-commerce Guide interface. The top navigation bar includes 'CMS Desk', 'Content', 'My Desk', 'Tools', and 'Administration'. The user is logged in as 'Global Administrator' on the 'E-commerce site'. The interface shows a sidebar with a tree view of the site structure, including 'E-commerce site', 'Home', 'News', 'Products', 'Cameras', 'Cell phones', 'MP3 Players', 'Notebooks', 'PDAs', 'PCs', 'Plasma TVs', 'How to buy', 'Company', 'Silverlight', 'Special pages', and 'Files'. The main content area is titled 'E-commerce starter site' and features a navigation menu with 'Home', 'News', 'Products', 'How to buy', 'Company', and 'Silverlight'. The 'Products' page is active, showing a search bar and a list of product categories: 'Cameras', 'Cell phones', 'MP3 Players', 'Notebooks', 'PDAs', 'PCs', and 'Plasma TVs'. The 'Plasma TVs' category is selected, and the page displays 'No products found' with an 'Add new product' button. The interface also includes a shopping cart notification, a newsletter subscription form, and a poll titled 'How did you find this site?'.

2.5 Adding product to multiple categories

You might need to add some product into more than one category. This chapter will help you to learn how to add a product to multiple categories.

















1. Go to **CMS Desk -> Content -> Products -> PCs** and click **New** at the document action toolbar.

The screenshot displays the CMS Desk interface. The top navigation bar includes 'Content', 'My Desk', 'Tools', and 'Administration'. The 'Content' menu is expanded, showing 'New', 'Delete', 'Copy', 'Move', 'Up', and 'Down'. The 'New' button is circled in red. The main content area shows the 'E-commerce starter site' with a navigation menu and a list of products under the 'PCs' category. The 'Add new product' button is visible above the product list. The interface also includes a search bar, a shopping cart notification, and a poll section.

2. Click **Link an existing document** at the bottom.

 **New document**



Please select new document type:

-  [Article](#)
-  [FAQ](#)
-  [File](#)
-  [Folder](#)
-  [Job opening](#)
-  [News](#)
-  [Office](#)
-  [Page \(menu item\)](#)
-  [Plasma TV](#)
-  [Press release](#)
-  [Product - Camera](#)
-  [Product - Cell phone](#)
-  [Product - Computer](#)
-  [Product - Laptop](#)
-  [Product - MP3 & MediaPlayer](#)
-  [Product - PDA](#)
-  [Simple article](#)

 [Link an existing document](#)

3. Now select **Apple MacBook Air** at **E-commerce Site -> Products -> Notebooks -> 13"** and click **Save**.

Products ▶ PCs

 Save  Save and create another

Please select the document to be linked:

Site:

- E-commerce Site
 - Home
 - News
 - Products
 - Cameras
 - Cell phones
 - MP3 Players
 - Notebooks
 - 13"
 - HP configurator
 - Apple MacBook Air
 - Toshiba Satellite Pro
 - 14"
 - 15"
 - 17"
 - PDA's
 - PC's
 - How to buy
 - Company
 - Special pages
 - Files

Apple MacBook Air has been added to the PCs category.

The screenshot displays an e-commerce website interface. At the top, there's a navigation bar with 'Home', 'News', 'Products', 'How to buy', and 'Company'. A search bar is on the left. The main content area is titled 'Electronics for you' and 'Products / PCs'. It features a grid of product listings, each with an image, name, price, and an 'Add to cart' button. The products include 'Configurable PC' (\$0.00), 'Compaq Presario' (\$659.00), 'Smart PC' (\$699.00), 'Force PC' (\$749.00), 'Tiger Extreme PC' (\$999.00), 'HP Pavilion PC a6140' (\$1399.00), and 'Apple MacBook Air' (\$2094.00). The MacBook Air is highlighted with a red box. On the right side, there are sections for 'Random products' (listing Pentax K10D, iPod Nano, HP Pavilion dv6680, and HP iPAQ 114), 'Latest news' (with two news items dated 2/13/2008), and a 'Newsletter subscription' form.

Please note:







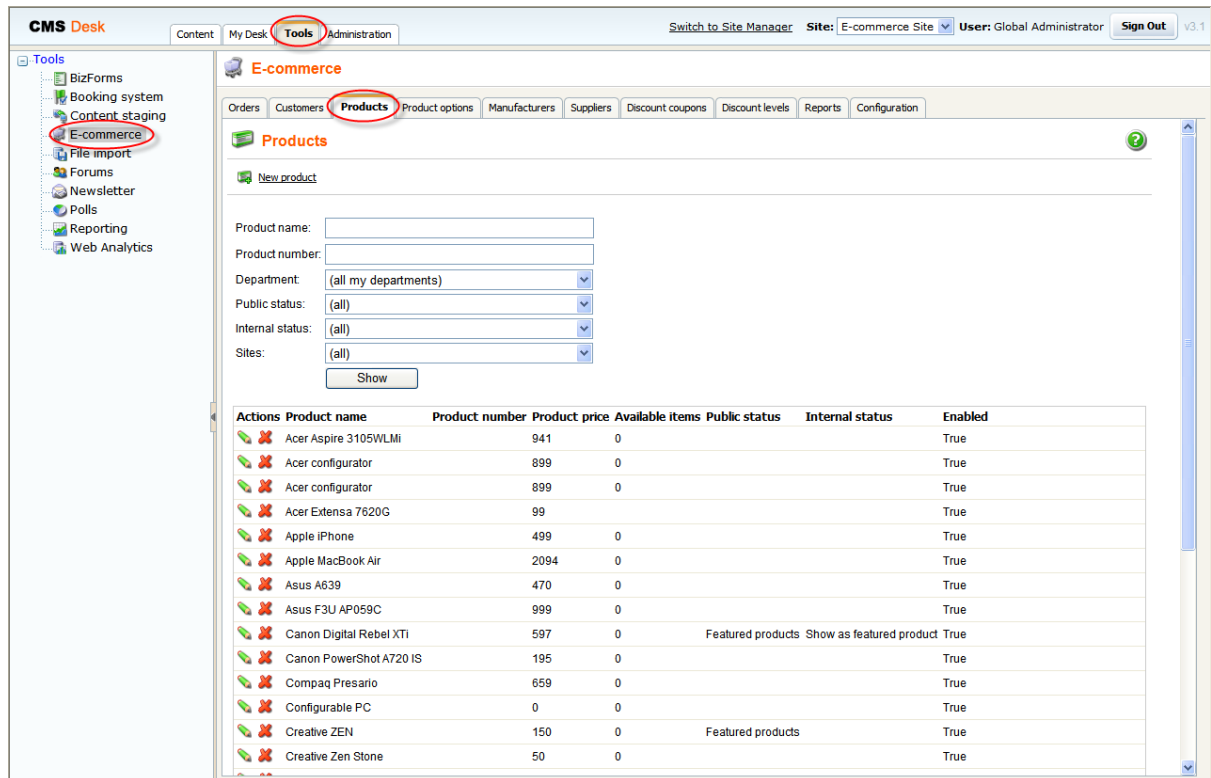





















- While copying a document, the same product (with the same SKU) that has been linked to the original document is linked to the new document as well.
- While creating link to an existing document, a product (SKU) is not directly related to the given link. The newly created link is an "image" of the existing document, so that the product is linked to the original document only.

2.6 Displaying featured products

1. Go to CMS Desk -> Tools -> E-commerce and choose Products tab.



The screenshot shows the CMS Desk interface. The top navigation bar includes 'CMS Desk', 'Content', 'My Desk', 'Tools', and 'Administration'. The 'Tools' menu is expanded on the left, showing options like 'BizForms', 'Booking system', 'Content staging', 'E-commerce', 'File import', 'Forums', 'Newsletter', 'Polls', 'Reporting', and 'Web Analytics'. The 'E-commerce' section is active, with sub-tabs for 'Orders', 'Customers', 'Products', 'Product options', 'Manufacturers', 'Suppliers', 'Discount coupons', 'Discount levels', 'Reports', and 'Configuration'. The 'Products' tab is selected, and a 'New product' form is visible. Below the form is a table of products with columns for 'Actions', 'Product name', 'Product number', 'Product price', 'Available items', 'Public status', 'Internal status', and 'Enabled'. The 'Apple iPhone' product is highlighted with a red circle.

Actions	Product name	Product number	Product price	Available items	Public status	Internal status	Enabled
 	Acer Aspire 3105WLMi	941	0				True
 	Acer configurator	899	0				True
 	Acer configurator	899	0				True
 	Acer Extensa 7620G	99	0				True
 	Apple iPhone	499	0				True
 	Apple MacBook Air	2094	0				True
 	Asus A639	470	0				True
 	Asus F3U AP059C	999	0				True
 	Canon Digital Rebel XTi	597	0		Featured products	Show as featured product	True
 	Canon PowerShot A720 IS	195	0				True
 	Compaq Presario	659	0				True
 	Configurable PC	0	0				True
 	Creative ZEN	150	0		Featured products		True
 	Creative Zen Stone	50	0				True

2. Click the **Edit** button next to the product which you want to display as a featured product.



A list of products with edit and delete icons. The 'Apple iPhone' product is highlighted with a red circle.

-   Acer Aspire 3105WLMi
-   Acer configurator
-   Acer configurator
-   Acer Extensa 7620G
-   Apple iPhone
-   Apple MacBook Air

- From the **Public status** drop-down menu, choose **Show as featured product** and click **Ok** at the bottom.

The screenshot shows the 'General' tab of a product configuration form. The form includes the following fields and options:

- Product name:** Apple iPhone
- Product number:** (empty)
- Description:** iPhone is a revolutionary new mobile phone that allows you to make a call by simply tapping a name or number in your address book, a favorites list, or a call log. It also automatically syncs all your contacts from a Windows PC, Mac, or Internet service. And it lets you select and listen to voicemail messages in whatever order you want — just like email.
- Price:** 499
- Enabled:**
- Department:** Phones
- Manufacturer:** Apple
- Supplier:** (none)
- Public status:** Show as featured product (highlighted with a red box)
- Internal status:** (none)
- Availability (days):** 0
- Product image URL:** [iphone_hero.jpg](#) (with an 'x' icon), Upload: Browse...
- Package:**
 - Package weight:
 - Package height:
 - Package width:
 - Package depth:
- Inventory:**
 - Available items: 3
 - Sell only if items are available:

The **OK** button at the bottom of the form is circled in red.

Your product has been added to the featured products.

The screenshot displays the home page of an "E-commerce starter site". At the top, there is a navigation bar with links for "Home", "News", "Products", "How to buy", and "Company", along with a "Sign In" button. A search bar is located on the left. The main content area features a "Special offer of notebooks" banner with an image of a woman and a laptop. Below this, four product tiles are displayed in a 2x2 grid: "iPod Shuffle" (price: \$79.00), "Apple iPhone" (price: \$499.00), "Creative ZEN" (price: \$150.00), and "Canon Digital Rebel XT" (price: \$597.00). The right sidebar contains a "Random product" section showing a "Pentax K10D" camera, a "Latest news" section with two news items dated 2/13/2008, and a "Newsletter subscription" form. The footer includes the "Powered by KENTICO" logo.

On home page, by default there are displayed 4 products randomly chosen from all products with public status set to **Show as featured product**. Should you want set different filters for displaying products on you home page or should you need more information about the **Random products** web part, please refer to the [Random products](#) chapter.

2.7 Sorting and paging products

1. Go to **CMS Desk** -> **Products** and switch to the **Design** tab. Click the **Configure** button of the **cmsdatalist** web part.

The screenshot displays the CMS Desk interface for an e-commerce site. The left sidebar shows the site structure with 'Products' highlighted. The main content area is in 'Design' mode, showing a product list. The 'cmsdatalist' web part is circled in red. The product list includes:

Product Name	Price	Action
Canon Digital Rebel XT	\$ 585.06	Add to cart
Canon PowerShot A720 IS	\$ 191.10	Add to cart
Nikon Coolpix S51	\$ 185.22	Add to cart

Additional products shown in the 'FeaturedProducts' section include:

- iPod Nano \$ 195.02
- Nikon D40 \$ 480.20
- Creative ZEN \$ 147.00
- iPod Classic \$ 245.00

The interface also shows a shopping cart with a total price of \$ 5211.00 and a search bar.

2. In the webpage dialog, find the **Content filter** section and enter *SKUPrice ASC* into the **ORDER BY expression** text box, then find the **Paging** section and enter *16* into the **Page size** checkbox. Now click **Ok**.

The screenshot shows the 'Web part properties (Datalist)' dialog box. The 'Content filter' section is expanded, showing the following fields and values:

- Document types: CMSProduct.Camera;CMSProduct (with a 'Select' button)
- Combine with default culture: Yes, No, Use site settings
- Culture code: (empty text box with a 'Select' button)
- Maximum nesting level: -1
- ORDER BY expression: SKUPrice ASC (highlighted with a red border)
- Select only published:
- Select top N documents: (empty text box)
- Site name: (empty text box with a 'Select' button)
- WHERE condition: NODESKUID IS NOT NULL

At the bottom of the dialog, the 'Refresh content' checkbox is checked. The 'OK', 'Cancel', and 'Apply' buttons are visible. The status bar at the bottom shows the URL: <http://petrvo3/CMS531/CMSDesk/PortalEngine/WebPartProperties.aspx?aliaspath=%2FProducts&zoneid=zoneLeft&webpartid> and 'Local intranet'.

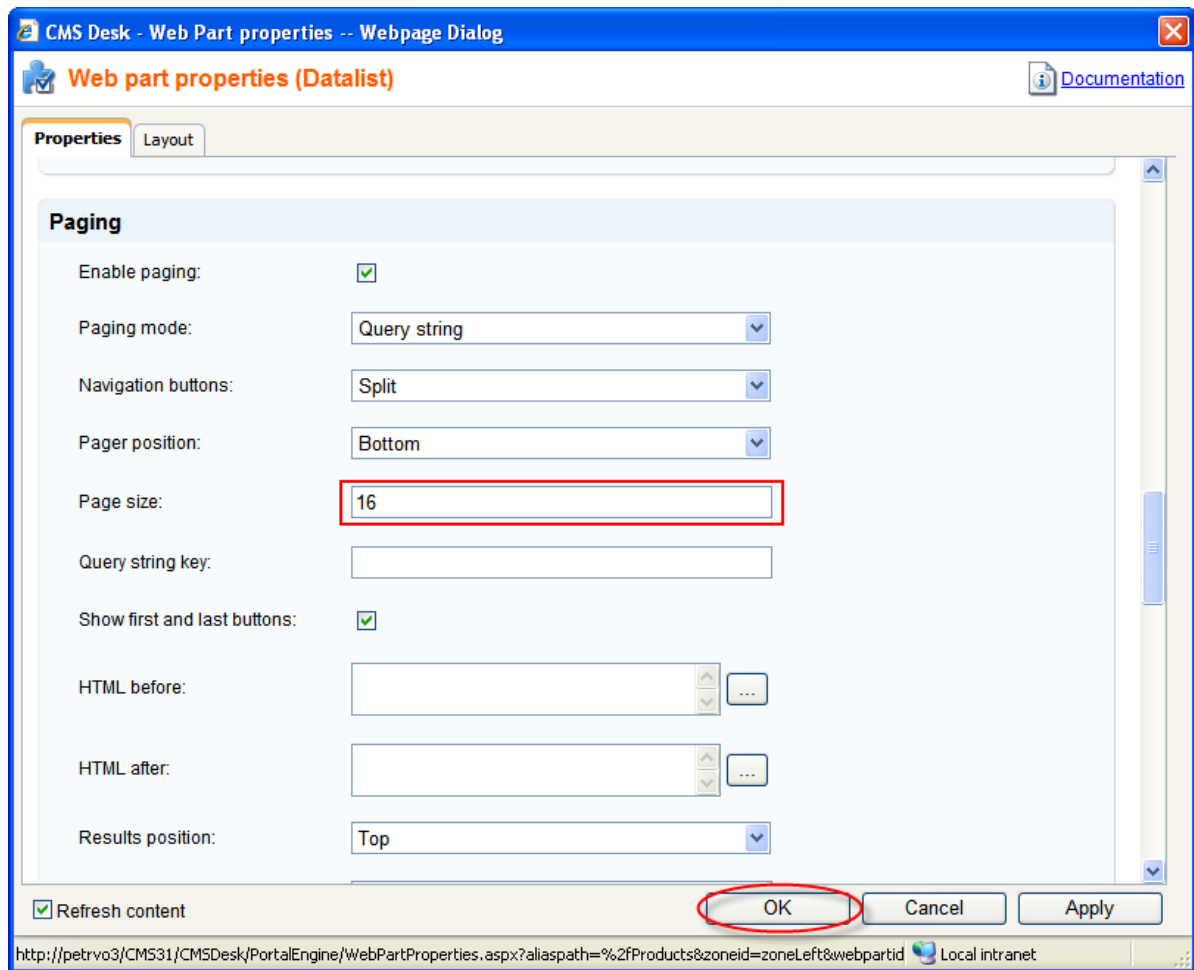

3. Switch to the **Preview** viewing mode. You can see that the products are sorted from the cheapest to the most expensive and there are 16 of them.

The screenshot shows an e-commerce website interface. At the top, there's a navigation bar with 'Home', 'News', 'Products', 'How to buy', and 'Company'. A search bar is on the left. The main content area is titled 'Electronics for you' and displays a grid of 16 camera products. The products are sorted by price, with the cheapest at the top and the most expensive at the bottom. Each product card includes an image, the product name, and its price. For example, the first row shows the Olympus Stylus FE-230 for \$159.00, the Nikon Coolpix S51 for \$189.00, and the Canon PowerShot A720 IS for \$195.00. The second row shows the Nikon D40 for \$490.00, the Canon Digital Rebel XTi for \$597.00, and the Pentax K10D for \$804.00. On the right side, there's a shopping cart icon indicating 'Your shopping cart is empty' and a 'Sign In' button. A sidebar on the left contains a 'Products' menu with categories like Cameras, Cell phones, MP3 Players, Notebooks, PDAs, and PCs. There's also a 'Poll' section asking 'How did you find this site?' and 'Quick links' for 'How to buy', 'Company', and 'News'.



Sorting products

You may decide to sort products in a different way.

Should you want to sort products from the most expensive to the cheapest, you would enter *SKUPrice DESC* into the **ORDER BY expression** text box.

You can choose to sort products alphabetically as well. For sorting from A to Z, enter *NodeName ASC*. For sorting from Z to A, enter *NodeName DESC* into the **ORDER BY expression** text box.

2.8 Changing company details

In this chapter, you will find out how to change your company details and add a new office.

Changing company details

1. Go to **CMS Desk -> Content -> E-commerce Site -> Company -> New York Office** and switch to the **Form** tab.

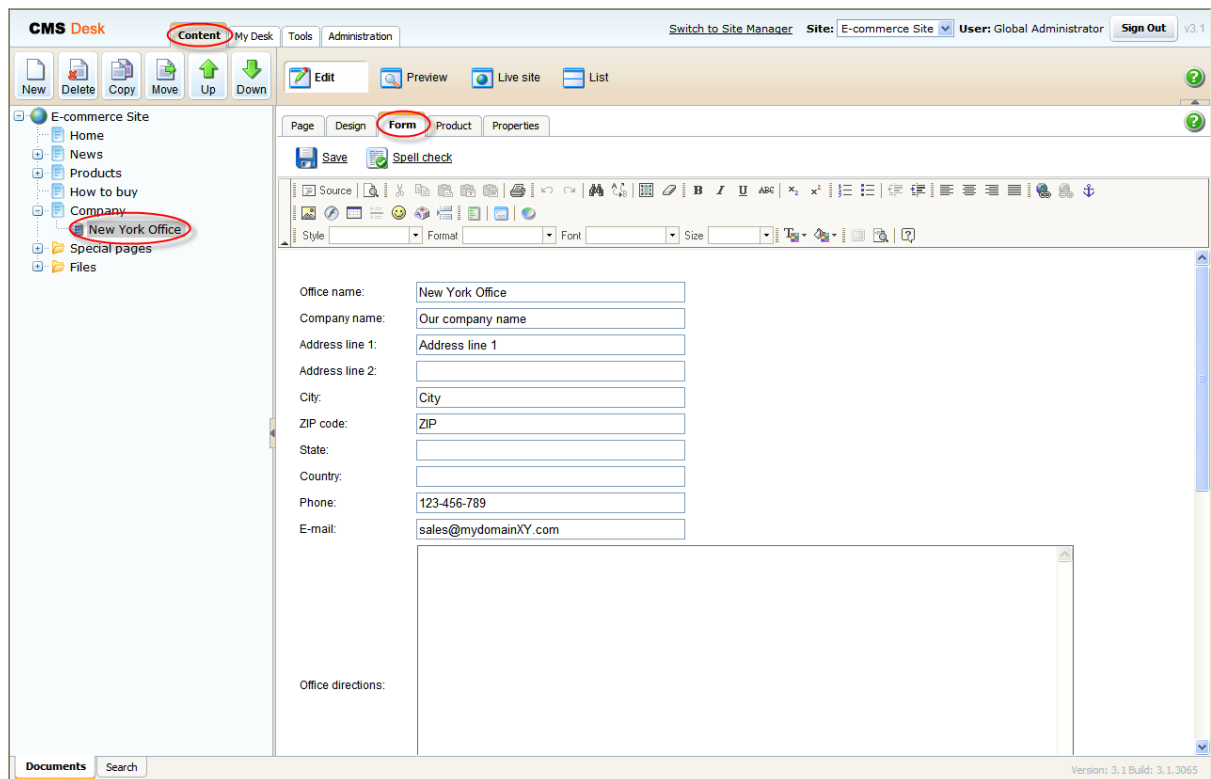

The screenshot displays the Kentico CMS 5.0 interface. The top navigation bar includes 'CMS Desk', 'Content', 'My Desk', 'Tools', and 'Administration'. The site is identified as 'E-commerce Site' and the user is 'Global Administrator'. The left sidebar shows a tree view with 'New York Office' selected under the 'Company' folder. The main content area is in 'Form' mode, showing a form with the following fields:

Office name:	<input type="text" value="New York Office"/>
Company name:	<input type="text" value="Our company name"/>
Address line 1:	<input type="text" value="Address line 1"/>
Address line 2:	<input type="text"/>
City:	<input type="text" value="City"/>
ZIP code:	<input type="text" value="ZIP"/>
State:	<input type="text"/>
Country:	<input type="text"/>
Phone:	<input type="text" value="123-456-789"/>
E-mail:	<input type="text" value="sales@mydomainNY.com"/>

Below the form is a large text area labeled 'Office directions:'. The interface also includes a 'Documents' search bar at the bottom left and a version number '3.1.3065' at the bottom right.

2. Enter your new company details:

- **Address line 1:** 316 W 49th St
- **City:** New York City
- **ZIP code:** 10019
- **State:** NY
- **Country:** United States

Then click **Save**.

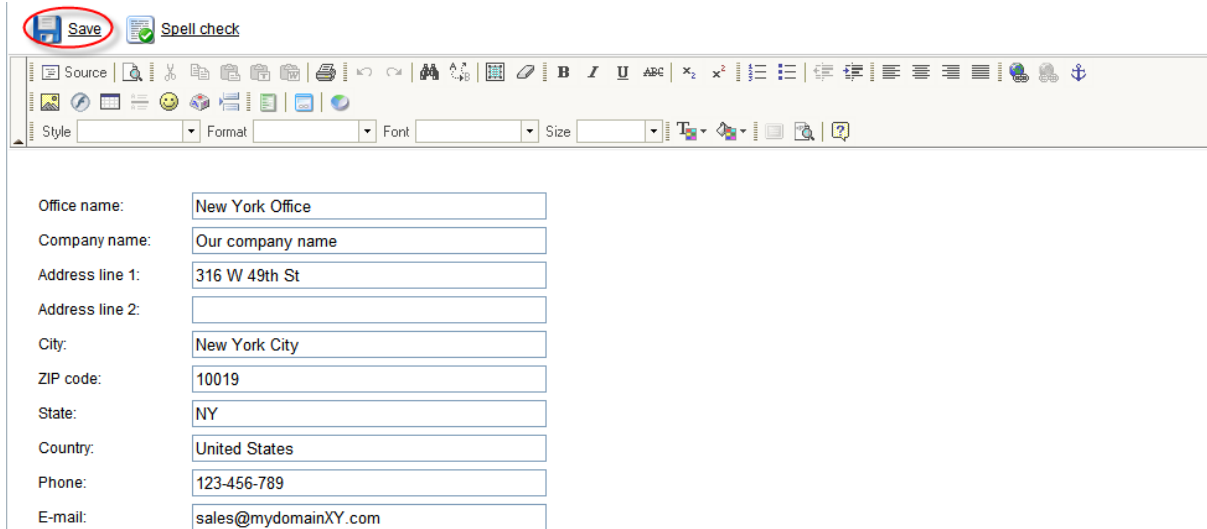

The screenshot shows a web form with a toolbar at the top. The toolbar includes a 'Save' button (circled in red) and a 'Spell check' button. Below the toolbar are several input fields for company details:

Office name:	New York Office
Company name:	Our company name
Address line 1:	316 W 49th St
Address line 2:	
City:	New York City
ZIP code:	10019
State:	NY
Country:	United States
Phone:	123-456-789
E-mail:	sales@mydomainXY.com

Please note: You can change the transformation of the company detail at **CMS Desk -> Content -> E-commerce Site -> Company -> New York Office -> Design -> <edit CompanyDetails> -> Transformations -> Transformation.**

The screenshot displays the Kentico CMS 5.0 interface in Design mode. The left sidebar shows the site structure with 'New York Office' selected under the 'Company' folder. The main content area shows the design view of the 'CompanyDetails' web part, with a red circle highlighting the 'Design' tab and another red circle highlighting the 'CompanyDetails' web part. A red arrow points from the 'CompanyDetails' web part to the 'Web part properties (Repeater)' dialog box.

The 'Web part properties (Repeater)' dialog box is open, showing the 'Transformations' section. The 'Transformation' dropdown is set to 'Ecommerce.Transformations.Ecom', which is highlighted with a red box. Other options include 'Alternating transformation' and 'Selected item transformation', each with 'Select' and 'Edit' buttons. The 'Item separator' field is also visible at the bottom.

Creating new office

1. Go to **CMS Desk -> Content -> E-commerce Site -> Company** and click the **New** button from the document action toolbar.

2. Choose **Office** as the new document type.

3. Now enter details for your new office:

- **Office name:** San Francisco Office
- **Address line 1:** 23 New Montgomery St
- **City:** San Francisco
- **ZIP code:** 94105
- **State:** CA
- **Country:** United States

Then scroll down a little bit and click **Browse** to select an image as **Office photo**. Then click **Save**.

The screenshot shows a web application interface for creating a new office. At the top, there is a toolbar with several icons, including a 'Save' icon which is circled in red. Below the toolbar, the form contains the following fields:

- Office name: San Francisco Office
- Company name: (empty)
- Address line 1: 23 New Montgomery St
- Address line 2: (empty)
- City: San Francisco
- ZIP code: 94105
- State: CA
- Country: United States
- Phone: (empty)
- E-mail: (empty)
- Office directions: (empty text area)
- Latitude: (empty)
- Longitude: (empty)
- Office photo: Upload: C:\Documents and Settings\ [Browse...]

The screenshot displays the Kentico CMS 5.0 E-commerce website interface. At the top, there is a navigation bar with links for Home, News, Products, How to buy, and Company. A search bar is located on the left side of the navigation bar. The main content area is divided into several sections:

- Products:** A list of product categories including Cameras, Cell phones, MP3 Players, Notebooks, PDAs, and PCs.
- Poll:** A section titled "How did you find this site?" with radio buttons for "Referred by a friend", "Print advertising", "Link from another web site", and "Search engine". A "Vote" button is at the bottom.
- Quick links:** A list of links for "How to buy", "Company", "News", and "Home".
- Our company:** A section with two office profiles:
 - New York Office:** Includes a photo, company name, address line 1, city, ZIP, phone number (123-456-789), email (sales@mydomainXY.com), and opening hours (Monday to Thursday 9.00am - 6.00pm, Friday 9.00am - 4.00pm).
 - San Francisco Office:** Includes a photo, address (23 New Montgomery St, San Francisco, CA 94105, United States), phone number, and email.
- Contact Us:** A section with the heading "If you wish to contact us, please use this form:" and a form with fields for "Your e-mail:", "Subject:", and "Message:". A "Send message" button is at the bottom.

At the top right, there is a shopping cart icon and a message: "Your shopping cart is empty".

Please note: In the **Form** tab, you can use the **Office description** text box to enter additional information about your office (e.g. opening hours). Should you feel this text box is not convenient for you (for instance you want to edit displayed text in the **Page** tab), you can always leave Office description blank and add the Text -> Editable text web part on the page instead.

Part

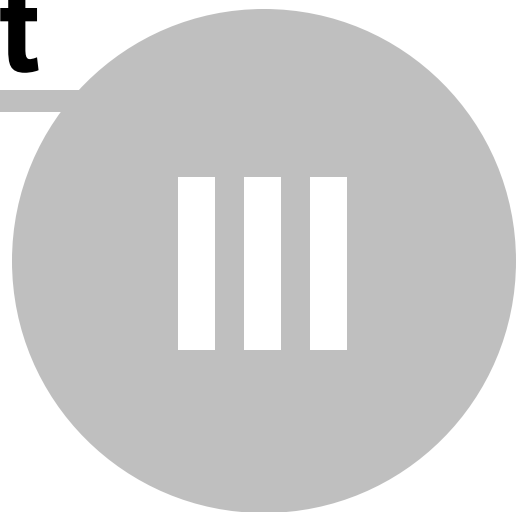

Customizing the product fields







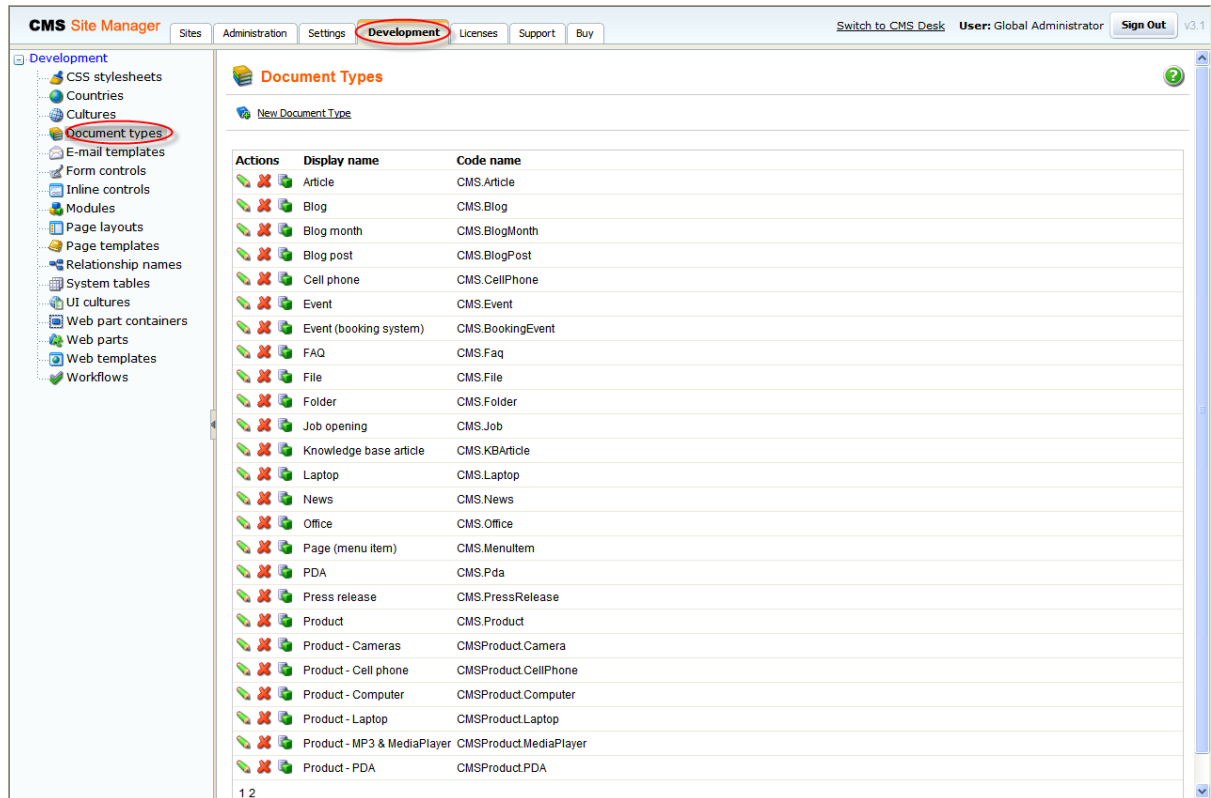











































3 Customizing the product fields

3.1 Defining a new product type

1. Go to Site Manager -> Development -> Document Types.



The screenshot shows the Kentico CMS Site Manager interface. The top navigation bar includes 'Sites', 'Administration', 'Settings', 'Development' (highlighted), 'Licenses', 'Support', and 'Buy'. The left sidebar shows a tree view with 'Development' expanded, and 'Document types' highlighted. The main content area displays the 'Document Types' section with a 'New Document Type' link. Below the link is a table with the following data:

Actions	Display name	Code name
 	Article	CMS.Article
 	Blog	CMS.Blog
 	Blog month	CMS.BlogMonth
 	Blog post	CMS.BlogPost
 	Cell phone	CMS.CellPhone
 	Event	CMS.Event
 	Event (booking system)	CMS.BookingEvent
 	FAQ	CMS.Faq
 	File	CMS.File
 	Folder	CMS.Folder
 	Job opening	CMS.Job
 	Knowledge base article	CMS.KBArticle
 	Laptop	CMS.Laptop
 	News	CMS.News
 	Office	CMS.Office
 	Page (menu item)	CMS.MenuItem
 	PDA	CMS.Pda
 	Press release	CMS.PressRelease
 	Product	CMS.Product
 	Product - Cameras	CMSProduct.Camera
 	Product - Cell phone	CMSProduct.CellPhone
 	Product - Computer	CMSProduct.Computer
 	Product - Laptop	CMSProduct.Laptop
 	Product - MP3 & MediaPlayer	CMSProduct.MediaPlayer
 	Product - PDA	CMSProduct.PDA

2. Click **New Document Type**.  [New Document Type](#)

3. You have been redirected the **New document type** wizard.

In the **Step 1**, enter:

- **Document type display name:** Plasma TV
- **Document type code name:** CustomProduct (**namespace**), television (**document type**)

Click **Next**.

Step 1 | **General**
Please enter document type display name (for users) and code name (it will be used in your code when necessary).

Document type display name:

Document type code name: namespace document type

4. In the **Step 2**, leave the default values and click **Next** again.

5. In the **Step 3**, you are asked to define attributes for the new document type. Click the **New Attribute**

button  and enter:

- **Attribute name:** TVName
- **Attribute size:** 100
- **Field caption:** Product name

From the **Field type** drop-down list, choose **Textbox** and click **Ok**.

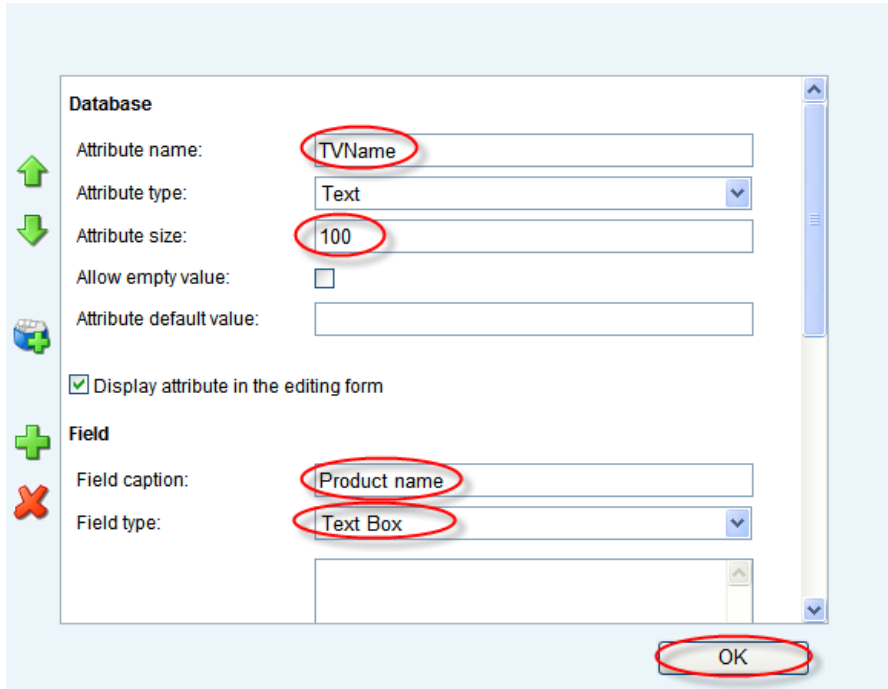

The screenshot shows the 'New Attribute' dialog box in Kentico CMS. It is divided into two main sections: 'Database' and 'Field'. The 'Database' section includes the following fields: 'Attribute name' (text box containing 'TVName'), 'Attribute type' (dropdown menu showing 'Text'), and 'Attribute size' (text box containing '100'). There is also an 'Allow empty value' checkbox which is unchecked, and an 'Attribute default value' text box which is empty. A checkbox labeled 'Display attribute in the editing form' is checked. The 'Field' section includes 'Field caption' (text box containing 'Product name') and 'Field type' (dropdown menu showing 'Text Box'). At the bottom right of the dialog is an 'OK' button. Red circles are drawn around the values 'TVName', '100', 'Product name', 'Text Box', and the 'OK' button.

6. Click **New Attribute** again. Enter:

- **Attribute name:** TVScreenType
- **Attribute size:** 100
- **Field caption:** Screen type

From the **Field type** drop-down list, choose **Textbox** and click **Ok**.





The screenshot shows a dialog box for creating a new attribute. It is divided into two main sections: 'Database' and 'Field'.
In the 'Database' section:
- 'Attribute name' is 'TVScreenType'.
- 'Attribute type' is 'Text'.
- 'Attribute size' is '100'.
- 'Allow empty value' is unchecked.
- 'Attribute default value' is empty.
- A checkbox 'Display attribute in the editing form' is checked.
In the 'Field' section:
- 'Field caption' is 'Screen type'.
- 'Field type' is 'Text Box'.
An 'OK' button is located at the bottom right of the dialog.

7. Now click **New Attribute** again and enter information for the last attribute:

- **Attribute name:** TVScreenSize
- **Attribute type:** Integer number
- **Field caption:** Screen size in inches

From the **Field type** drop-down list, choose **Textbox** and click **Ok**.

Step 3 | **Fields**
Please define custom attributes of the document type and their appearance in the editing form. You can define attributes, such as product number, product weight, press release text, etc.

televisionID TVName TVScreenType New Attribute	    	Database Attribute name: TVScreenSize Attribute type: Integer Number Attribute size: <input type="text"/> Allow empty value: <input type="checkbox"/> Attribute default value: <input type="text"/> <input checked="" type="checkbox"/> Display attribute in the editing form Field Field caption: Screen size in inches Field type: Text Box
---	--	--

OK

Next

8. In the **Step 4**, choose *TVName* in the **Document name source** drop-down list. Click **Next**.

Step 4 | **Additional settings**
Please choose the source field that will be used as a document name. You can choose either one of the custom fields or you can choose to use document name as a separate field.

Document name source:

Next

9. In the **Step 5**, check the **Page(menu item)** checkbox. Click **Next**.

Step 5 | **Parent types**
Please select document types under which this document template can be placed.

<input type="checkbox"/>	File	CMS.File
<input type="checkbox"/>	Folder	CMS.Folder
<input type="checkbox"/>	Job opening	CMS.Job
<input type="checkbox"/>	Knowledge base article	CMS.KBArticle
<input type="checkbox"/>	Laptop	CMS.Laptop
<input type="checkbox"/>	News	CMS.News
<input type="checkbox"/>	Office	CMS.Office
<input checked="" type="checkbox"/>	Page (menu item)	CMS.Menuitem
<input type="checkbox"/>	PDA	CMS.Pda
<input type="checkbox"/>	Plasma TV	CustomProduct.television
<input type="checkbox"/>	Press release	CMS.PressRelease
<input type="checkbox"/>	Product	CMS.Product

Next

10. Now make sure that the **Select** checkbox next to the Ecommerce site is checked and click **Next**.

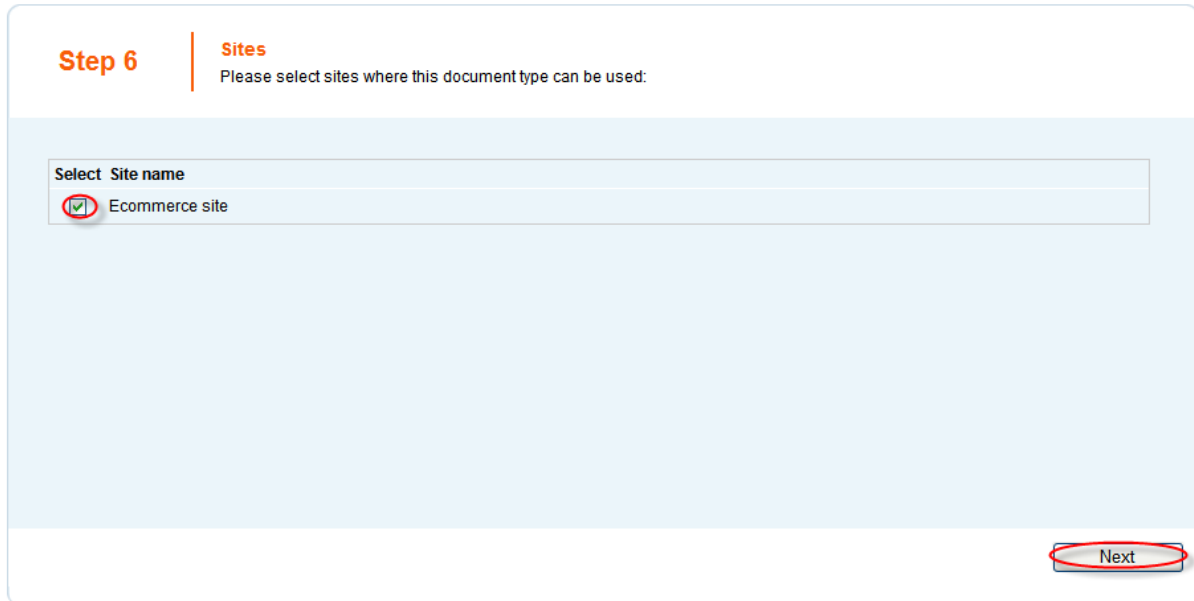

Step 6 | **Sites**
Please select sites where this document type can be used:

Select	Site name
<input checked="" type="checkbox"/>	Ecommerce site

Next

11. Click **Finish**.

12. Now go to **CMS Desk -> Products -> Plasma TV** and click **New** at the document action toolbar. You'll see that you can choose **Plasma TV** as the new document type.



Adding attributes

This chapter explains how to add an attribute to specific document type. (e.g. product-camera, product - cell phones).

For adding attribute common to all products, please refer to the [Adding product custom fields](#) chapter.



Changing document type icon

The default icon is created with the new document type. Should you want to replace this icon with your own, go to **<your web project folder> \App_Themes\Default\Images\ CMSDesk\icons** and find the file named **<namespace>_<your new document type>.gif** (in our example, this is going to be **CustomProduct_television.gif**). All you have to do is replace this file with the image file of your new icon. Please note that the new file has to be named the same as the one being replaced.

3.2 Customizing product design

Editing existing transformation

1. Go to **CMS Site Manager** -> **Development** -> **Document types**, choose the **Plasma TV** document type and switch to the **Transformation** tab.

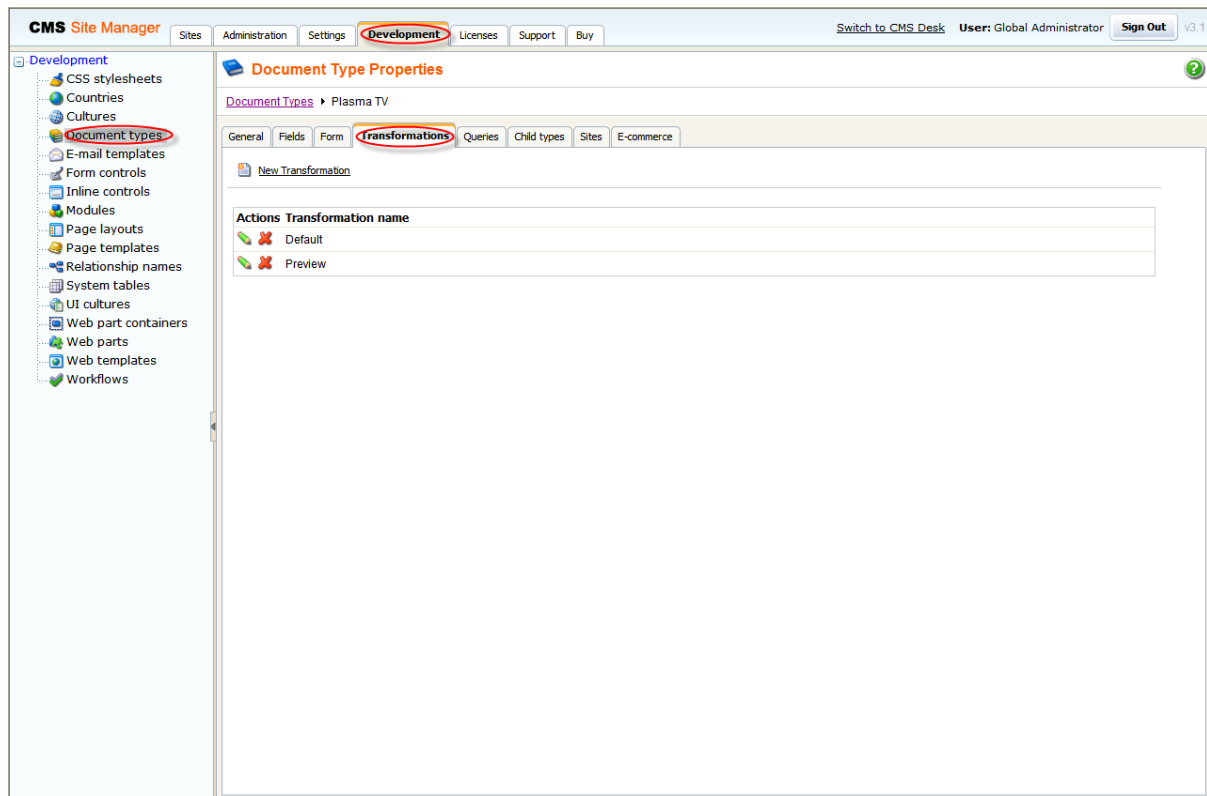

2. Click the **Edit transformation** button next to the **Default** transformation name.

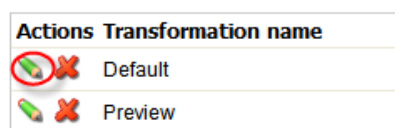

3. Delete the content of the **Code** text box and insert the code from the gray box bellow. This code will change the transformation to display only the name of a TV and its screen type. Click **Save** at the top.



```
<table>
  <tr>
    <td>Product name:</td>
    <td><%= Eval("TVName") %></td>
  </tr>
  <tr>
    <td>Screen type:</td>
    <td><%= Eval("TVScreenType") %></td>
  </tr>
</table>
```

Document Type Properties

Document Types ▶ Plasma TVs

General Fields Form **Transformations** Queries Child types Sites E-commerce

Transformations ▶ Default

 Save  Check out to file 

You can check out the transformation to file C:\inetpub\wwwroot\KenticoCMS-e-commerce\CMSTransformations\cms\television\default.ascx to edit transformation externally.

Transformation name:

Transformation type:

Code:

```

<%@ Control Language="C#" AutoEventWireup="true" Inherits="CMS.Controls.CMSAbstractTransformation" %>
<%@ Register TagPrefix="cc1" Namespace="CMS.Controls" Assembly="CMS.Controls" %>
<table>
  <tr>
    <td>Product name:</td>
    <td><%= Eval("TVName") %></td>
  </tr>
  <tr>
    <td>Screen type:</td>
    <td><%= Eval("TVScreenType") %></td>
  </tr>
</table>

```

Transformation expression examples:

<%= Eval("NewsTitle") %>	Displays value of the given field.
<%= GetDocumentUrl() %>	Inserts URL of the rendered document.
<%= GetDocumentUrl("NodeGUIDColumn", "NodeAlias") %>	Inserts URL of the specified document.
<%= GetDocumentLink() %>	Inserts a complete HTML code of the link pointing to the rendered document.

That's how you change default transformation for your product so that the product name and screen type are displayed.

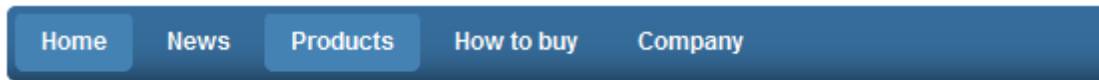

[Products](#) > [Plasma TVs](#) > LG plasma TV 42PC51

Product name: LG plasma TV 42PC51

Screen type: Plasma

Please note: You can modify the design of the **product list** web part by changing the **CMS.Root.EcommerceProductsList** transformation in the manner similar to the given example.



Adding namespaces

You can add additional namespaces into the **web.config** file in the following location:

```
<system.web>
  <pages validateRequest="false">
    <namespaces>
      <add namespace="CMS.CMSHelper"/>
      <add namespace="CMS.GlobalHelper"/>
    </namespaces>
  </pages>
</system.web>
```

In case you add namespace into the **web.config** file, you don't have to specify it when calling its objects in transformations. Therefore, instead of calling **CMS.GlobalHelper.ResHelper.GetString("MyCustomString")**, you could call just **ResHelper.GetString("MyCustomString")**.



Print page

Kentico CMS allows you to add a link button to your web page that will create print version of the given document. Please refer to the **Print page** chapter in **Kentico CMS Developer's Guide** for more information.

3.3 Adding images to product gallery

Now you will learn how to add images to product gallery.

The images in the product gallery are displayed using the **Attachments image gallery** web part. Therefore, it is essential that you have placed this web part into your product page template.

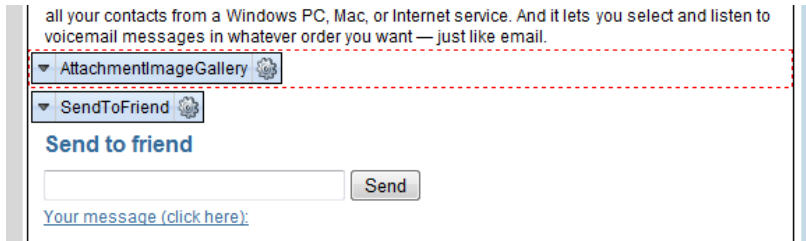

The images of a product are stored as attachments to the document. To add images to the product, go to **CMS Desk -> Content -> Edit -> Properties -> Attachments** tab and select the product you want to add the images to.

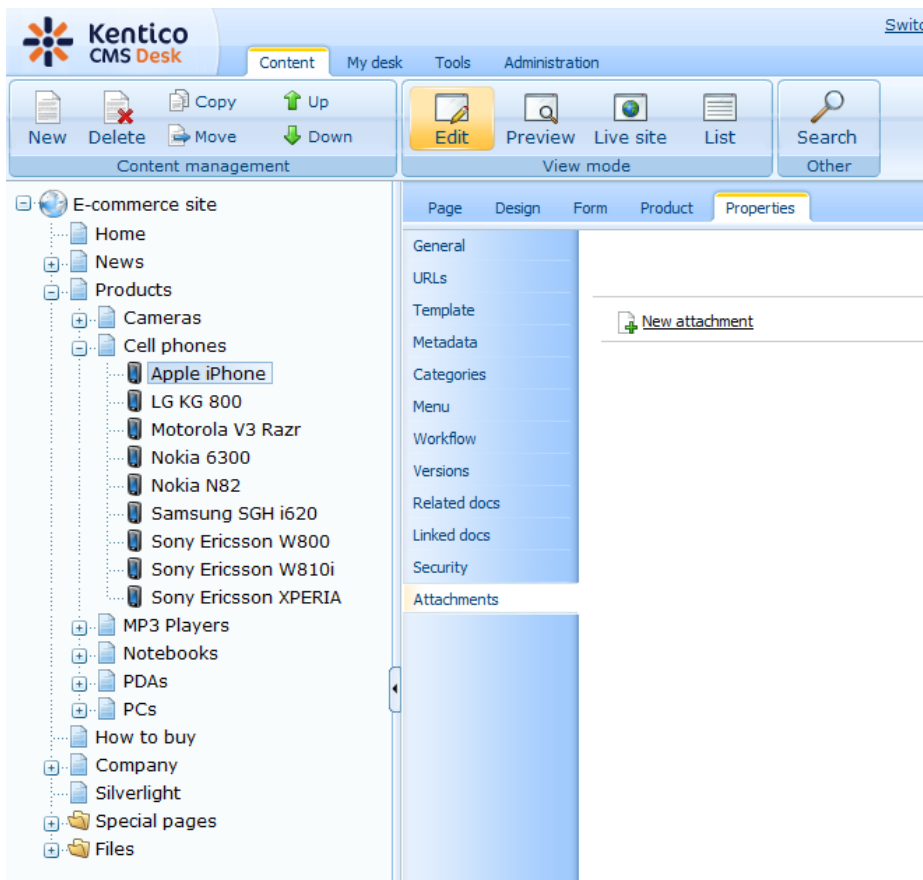

By clicking on the **New attachment** () link, a dialog for uploading files appears where you can add images. Just select the desired image and click **Open**. Repeat the procedure for all images you want to attach.

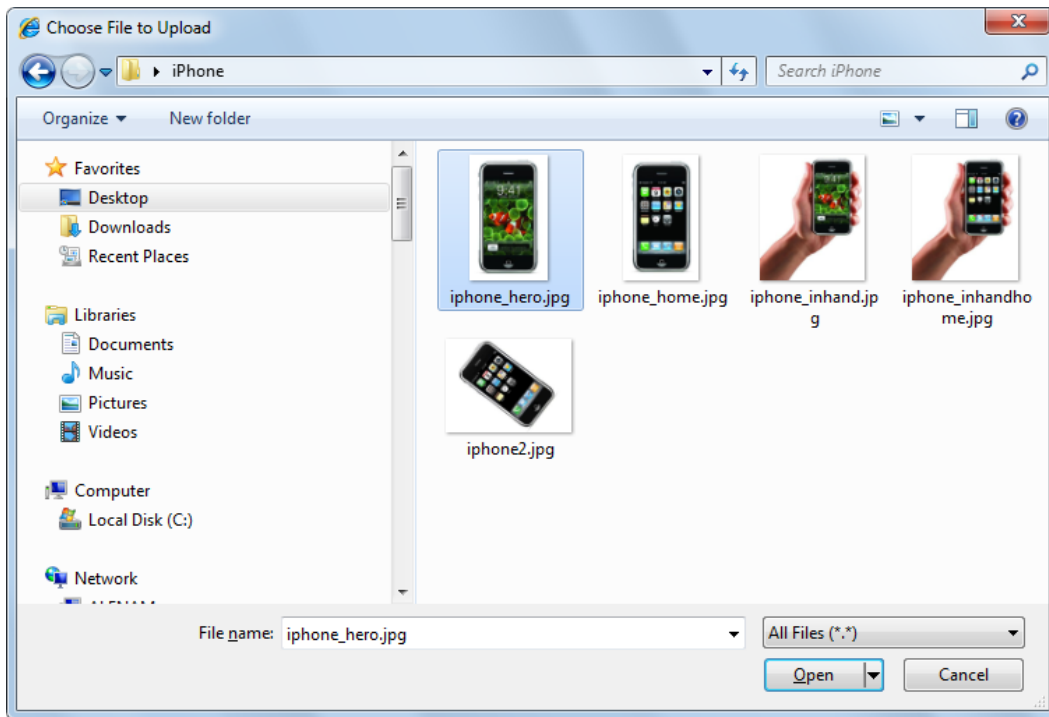

The images are stored as attachments of the product.

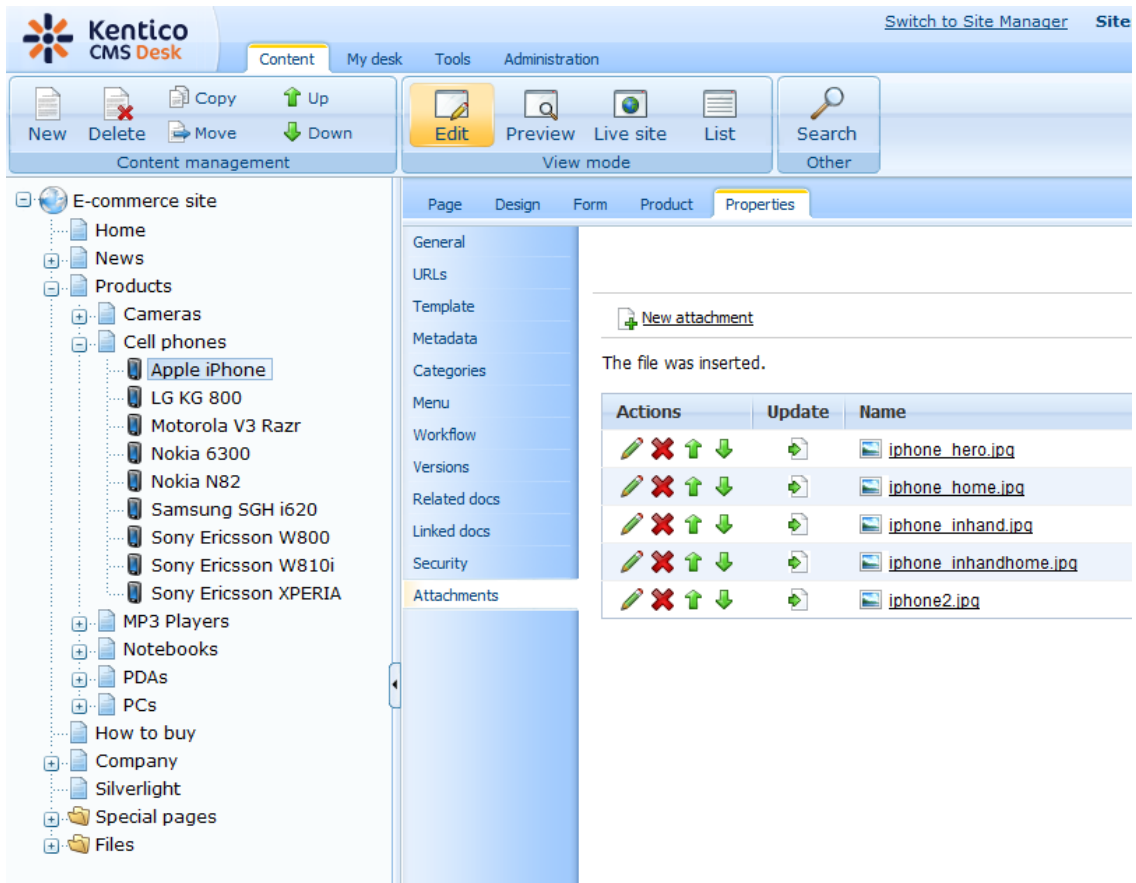

You can arrange the images in the attachment using the **Move up** (↑) and **Move down** (↓) icons. Images can be edited via the **Edit** (✎) icon, or deleted by clicking on the **Delete** (✖) icon.

When the images are attached to the product, you can display them on the live site within the **Attachments image gallery** web part.

The screenshot shows the Kentico CMS Desk interface. The top navigation bar includes 'Content', 'My desk', 'Tools', and 'Administration'. The toolbar contains icons for 'New', 'Delete', 'Move', 'Down', 'Edit', 'Preview', 'Live site', 'List', and 'Search'. The left sidebar shows a tree view of the site structure, with 'E-commerce site' expanded to show 'Products' and 'Cell phones'. The main content area displays a product page for an iPhone. It includes a price of \$499.00, a list of accessories (Car charger, Headset, Leather case), a description of the iPhone, and a product gallery with five images of the iPhone.

Now you will learn how to add an image to product gallery.

Before you proceed, you need to check if images can be placed under the document type of the document where you want the images to be placed.

1. Go to **CMS Desk's Edit** mode, select the document and switch to the **Properties -> General** tab. You can see the document's document type in the Type field.

CMS Desk Content My Desk Tools Administration [Switch to Site Manager](#) Site: E-commerce site User: Global Administrator

New Delete Copy Move Up Down Edit Preview Live site List

E-commerce site

- Home
- News
- Products
 - Cameras
 - Cell phones
 - Apple iPhone**
 - iPhone_1
 - iPhone_2
 - iPhone_3
 - iPhone_4
 - iPhone_5
 - LG KG 800
 - Motorola V3 Razr
 - Nokia 6300
 - Nokia N82
 - Samsung SGH i620
 - Sony Ericsson W800
 - Sony Ericsson W810i
 - Sony Ericsson XPERIA
 - MP3 Players
 - Notebooks
 - PDAs
 - PCs
 - How to buy
 - Company
 - Silverlight
 - Special pages
 - Files

Page Design Form Product **Properties**

General Save

URLs

Template

Metadata

Categories

Menu

Workflow

Versions

Related docs

Linked docs

Security

Design

CSS stylesheet: (default) Inherit

Other properties

Document name: **Apple iPhone**

Type: **Product - Cell phone**

Created by: Global Administrator

Created: 2/19/2008 6:03:11 PM

Last modified by: Global Administrator

Last modified: 2/29/2008 1:39:26 PM

Owner: Global Administrator

Owned by group:

Rating: ☆☆☆☆☆☆☆☆

N/A

Node ID: 319

Node GUID: 77a29eb5-96cc-4f3c-9067-c0b74f39b88

Alias path: /Products/Cell-phones/Apple-iPhone

Culture: English - United States

Name path: /Products/Cell phones/Apple iPhone

Live URL: http://localhost/KenticoCMS_0302/Products/Cell-phones/Apple-iPhone.aspx

Published: Yes

2. Go to Site Manager -> Development -> Document types. Choose to Edit () the document type from the previous step. Switch to the **Child types** tab and choose the desirable document types that you want to place under the documents of this type. For images, select **CMS.File** and click **OK**.

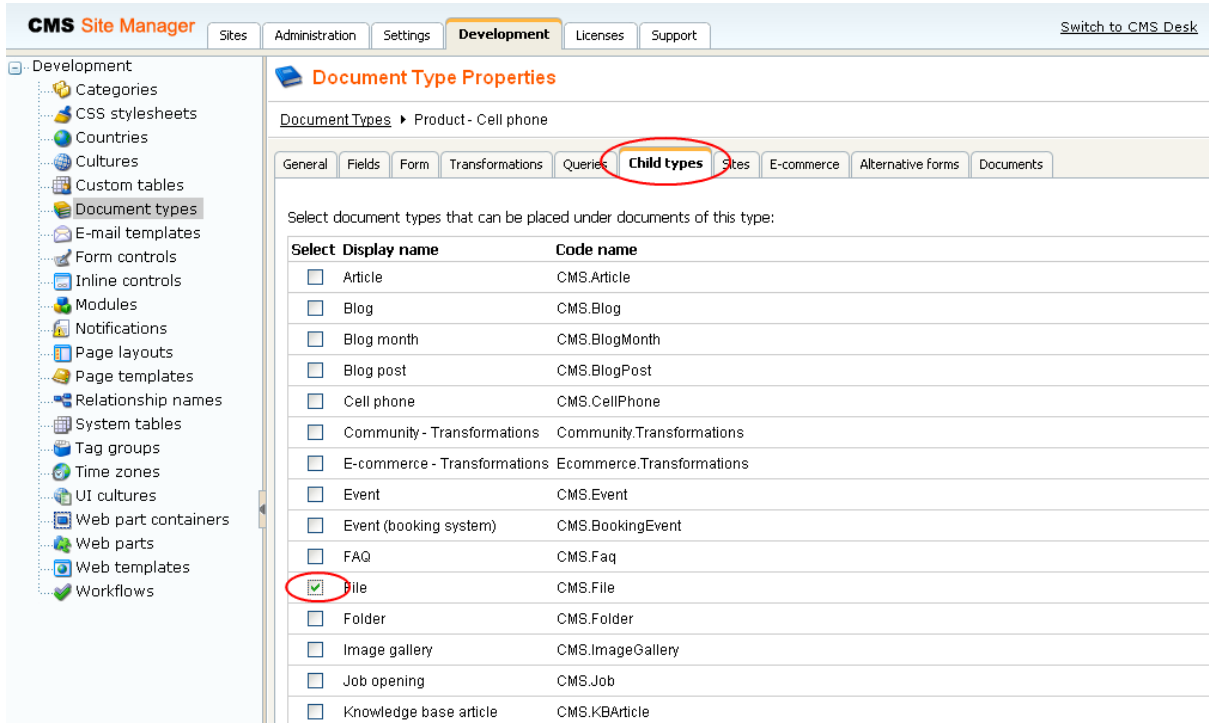

The screenshot shows the 'Document Type Properties' dialog in the Kentico CMS Site Manager. The 'Development' tab is active, and the 'Document Types' section is expanded to 'Product - Cell phone'. The 'Child types' tab is selected, and the 'File' document type is checked in the list.

Select	Display name	Code name
<input type="checkbox"/>	Article	CMS.Article
<input type="checkbox"/>	Blog	CMS.Blog
<input type="checkbox"/>	Blog month	CMS.BlogMonth
<input type="checkbox"/>	Blog post	CMS.BlogPost
<input type="checkbox"/>	Cell phone	CMS.CellPhone
<input type="checkbox"/>	Community - Transformations	Community.Transformations
<input type="checkbox"/>	E-commerce - Transformations	Ecommerce.Transformations
<input type="checkbox"/>	Event	CMS.Event
<input type="checkbox"/>	Event (booking system)	CMS.BookingEvent
<input type="checkbox"/>	FAQ	CMS.Faq
<input checked="" type="checkbox"/>	File	CMS.File
<input type="checkbox"/>	Folder	CMS.Folder
<input type="checkbox"/>	Image gallery	CMS.ImageGallery
<input type="checkbox"/>	Job opening	CMS.Job
<input type="checkbox"/>	Knowledge base article	CMS.KBArticle

Now when images can be placed under our document type, we can add them the following way:

1. Go to **CMS Desk** -> **Content** -> **Products** -> **Cell phones** -> **Apple iPhone**.

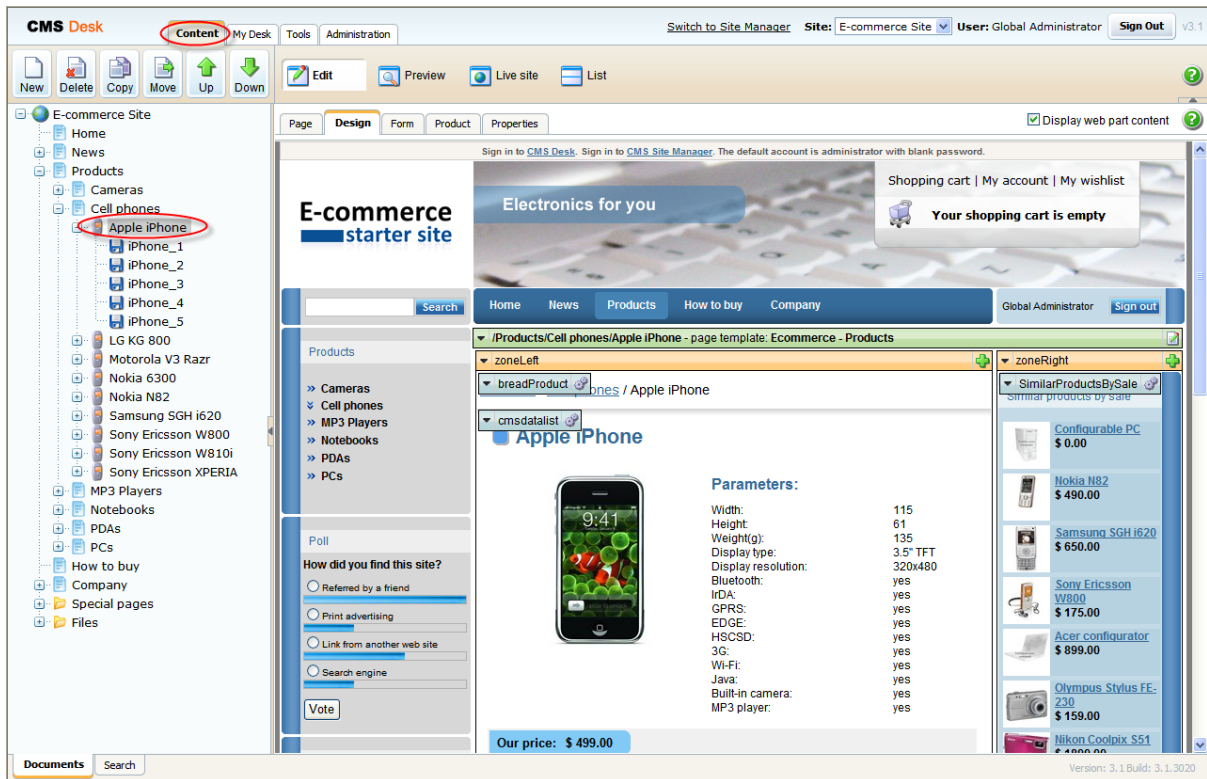

2. Click **New** at the document action toolbar.

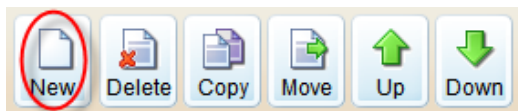

3. Click **File**.  **File**

4. Click **Browse...**

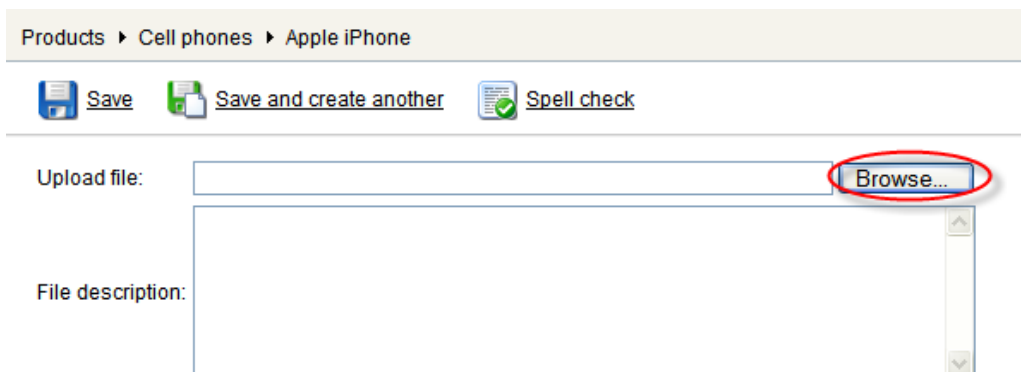

5. Find an image you want to upload and click **Open**.

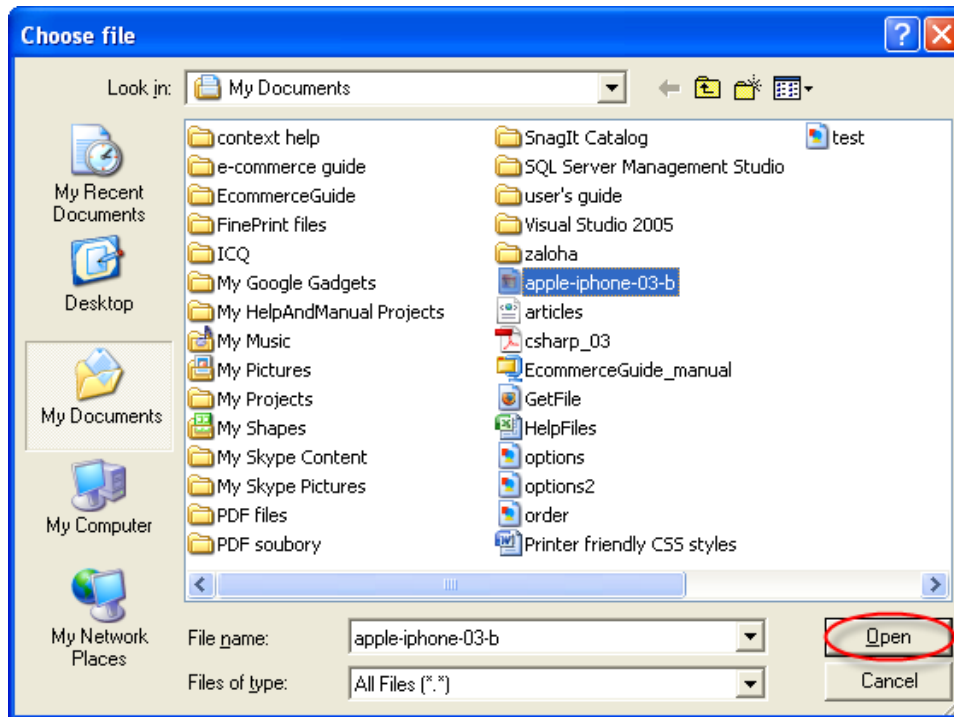

6. Now click **Save**.

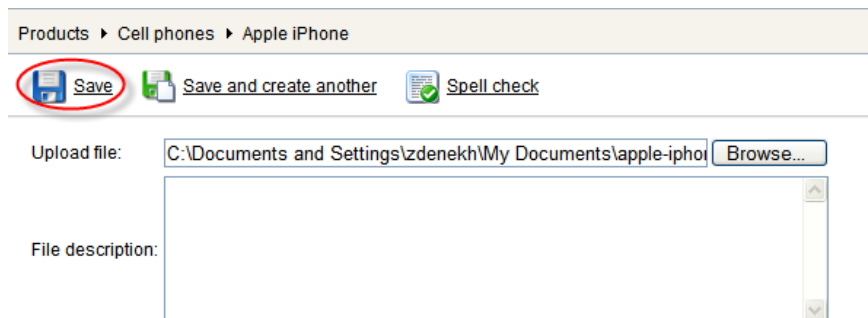

Congratulations, your image has been added to the product gallery.



Removing images from product gallery

The document action toolbar, mentioned in the step 2, can be used not only for adding new images to product gallery but for removing them as well.

In the content tree, choose image you want to remove and click **Delete** in the document action toolbar. Your image will be removed from the product gallery.

Apple iPhone



Parameters:

Width:	115
Height:	61
Weight(g):	135
Display type:	3.5" TFT
Display resolution:	320x480
Bluetooth:	yes
IrDA:	yes
GPRS:	yes
EDGE:	yes
HSCSD:	yes
3G:	yes
Wi-Fi:	yes
Java:	yes
Built-in camera:	yes
MP3 player:	yes

Our price: \$ 499.00

Cell phones accessories

- Car charger (+ \$ 5.00)
 Headset (+ \$ 70.00)
 Leather case (+ \$ 10.00)

Add to wishlist

1

Add to cart

Description

iPhone is a revolutionary new mobile phone that allows you to make a call by simply tapping a name or number in your address book, a favorites list, or a call log. It also automatically syncs all your contacts from a Windows PC, Mac, or Internet service. And it lets you select and listen to voicemail messages in whatever order you want — just like email.

Product gallery



3.4 Adding product custom fields

1. Go to CMS Site Manager -> Development -> System tables.

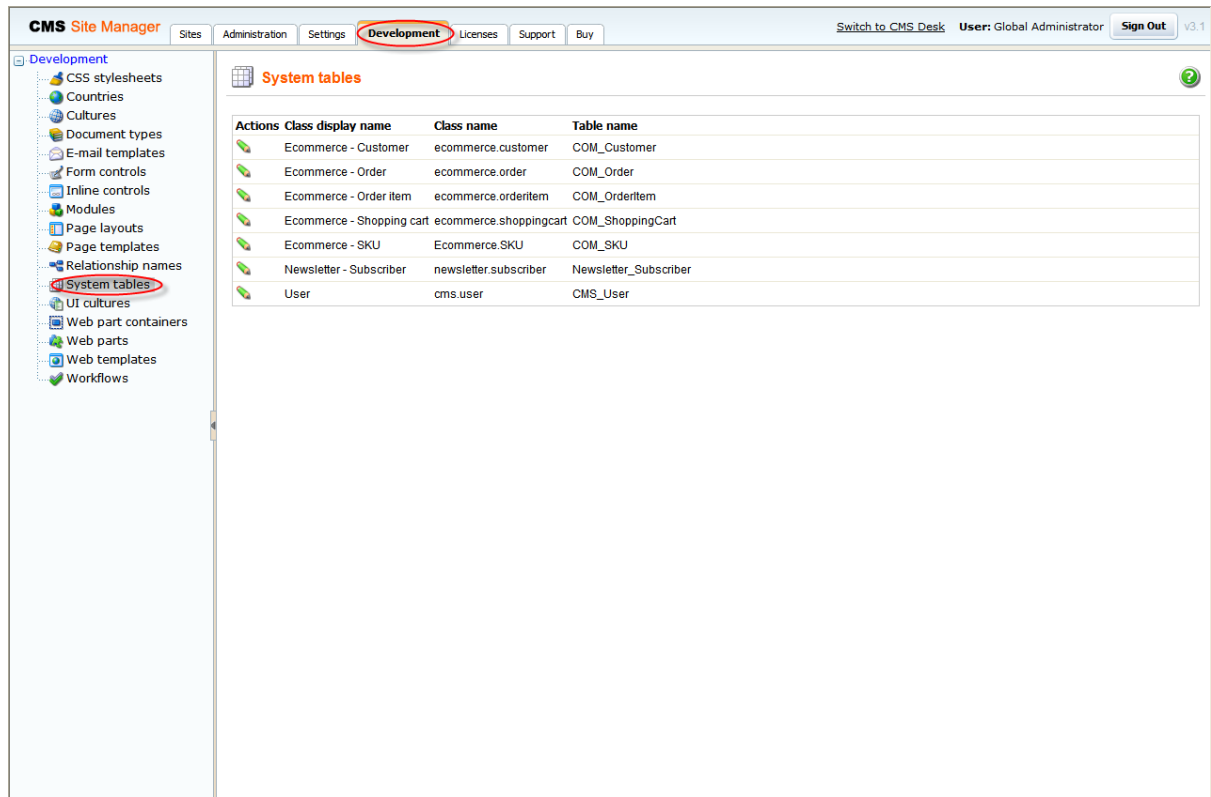

The screenshot shows the CMS Site Manager interface. The 'Development' tab is selected in the top navigation bar. In the left-hand navigation pane, the 'System tables' link is highlighted with a red circle. The main content area displays a table titled 'System tables' with the following data:

Actions	Class display name	Class name	Table name
	Ecommerce - Customer	ecommerce.customer	COM_Customer
	Ecommerce - Order	ecommerce.order	COM_Order
	Ecommerce - Order item	ecommerce.orderitem	COM_Orderitem
	Ecommerce - Shopping cart	ecommerce.shoppingcart	COM_ShoppingCart
	Ecommerce - SKU	Ecommerce.SKU	COM_SKU
	Newsletter - Subscriber	newsletter.subscriber	Newsletter_Subscriber
	User	cms.user	CMS_User

2. Click **Edit** next to the **Ecommerce - SKU**.

	Ecommerce - Shopping cart	ecommerce.shoppingcart	COM_ShoppingCart
	Ecommerce - SKU	Ecommerce.SKU	COM_SKU
	Newsletter - Subscriber	newsletter.subscriber	Newsletter_Subscriber

3. Click **New Attribute**. 

4. Into the **Attribute name** text box, enter *SKUColor*. Choose **Text** as **Attribute type**, enter *100* as **Attribute size** and *Product color* as **Field Caption**. Choose **Text box** as **Field Type**. Click **Ok**.

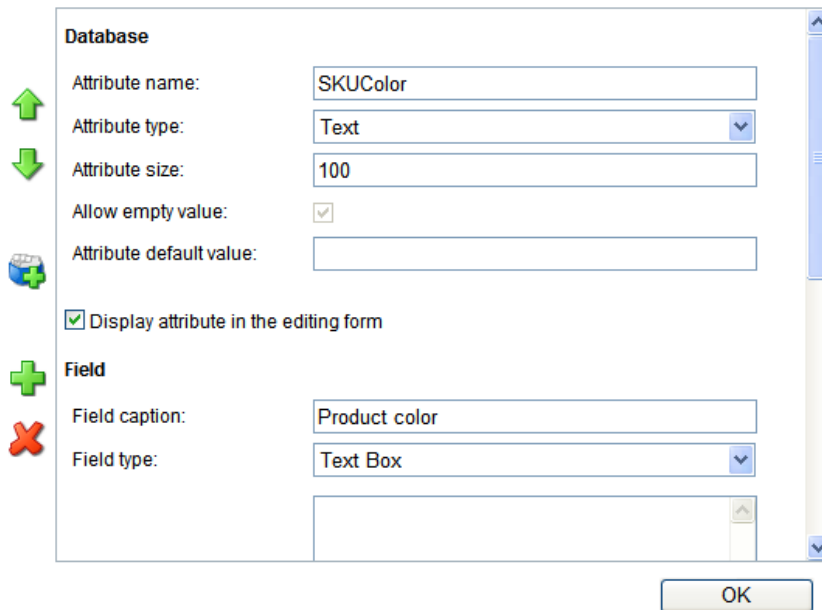

The screenshot shows a configuration dialog box with two main sections: **Database** and **Field**. In the **Database** section, the **Attribute name** is *SKUColor*, **Attribute type** is **Text**, **Attribute size** is *100*, **Allow empty value** is checked, and **Attribute default value** is empty. The **Display attribute in the editing form** checkbox is also checked. In the **Field** section, the **Field caption** is *Product color* and the **Field type** is **Text Box**. An **OK** button is located at the bottom right of the dialog.

5. Now switch to **CMS Desk** and go to **Tools -> E-commerce -> Products**. Click **Edit** next to **Acer Aspire 3105WLMi**.

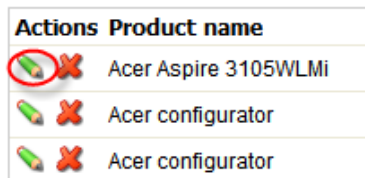

The screenshot shows a list of actions for a product. The first action, **Acer Aspire 3105WLMi**, is circled in red and has a red 'X' icon next to it, indicating it is the selected action for editing.

6. Switch to the **Custom fields** tab and enter *Blue* into the **Product color** text box. Then click **Ok**.

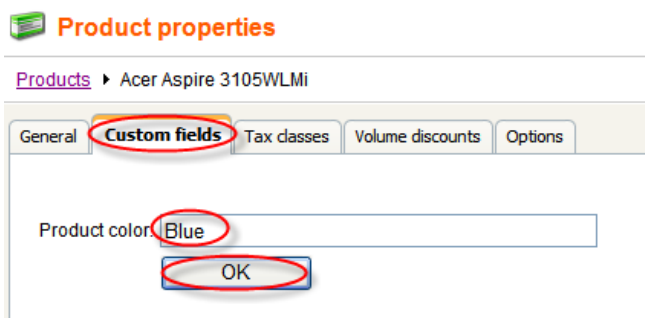

The screenshot shows the **Product properties** dialog box for **Acer Aspire 3105WLMi**. The **Custom fields** tab is selected and circled in red. The **Product color** text box contains the value *Blue* and is also circled in red. The **OK** button is circled in red at the bottom.

That's how you create a custom field for all products and how you set its value for specific product.

Product custom fields in transformations

For displaying values of the given custom field in transformation, enter `Eval("<custom field name>")`. For instance, for the example given in this chapter, you would enter `Eval("SKUColor")` (please see the [Customizing product design](#) chapter for more details).

In versions prior to 4.0, you had to update the following database views manually with the name of the new custom field in order for the `Eval("<custom field name>")` to work correctly. Now it is done **automatically** so that you **don't need to modify the database** at all.

1. `View_COM_SKU`
2. `View_CMS_Tree_Joined`
3. `View_CMS_Tree_Joined_Versions`

Product custom fields in code

In code, you can get and set the given value in the following way:

```
using System;
using CMS.Ecommerce;

// How to set value of the custom field
SKUInfo product = new SKUInfo();
product.SetValue("SKUColor", "green");

// How to get value of the custom field
string color = Convert.ToString(product.GetValue("SKUColor"));
```

Part

IV

Customizing web site design

4 Customizing web site design

4.1 Changing the header and menu (master page)

Changing a logo in the header

1. Go to **CMS Desk** -> **Content** -> **Ecommerce site**.

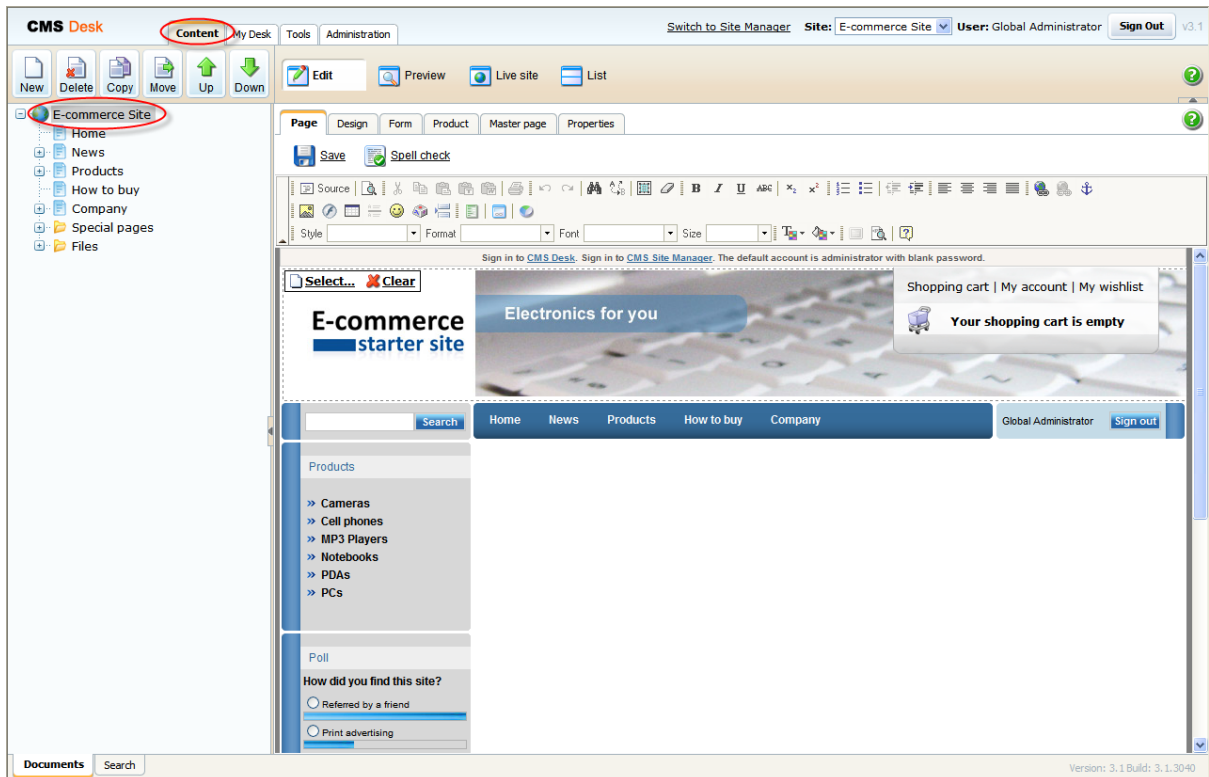

2. Click **Select ...** above the logo.

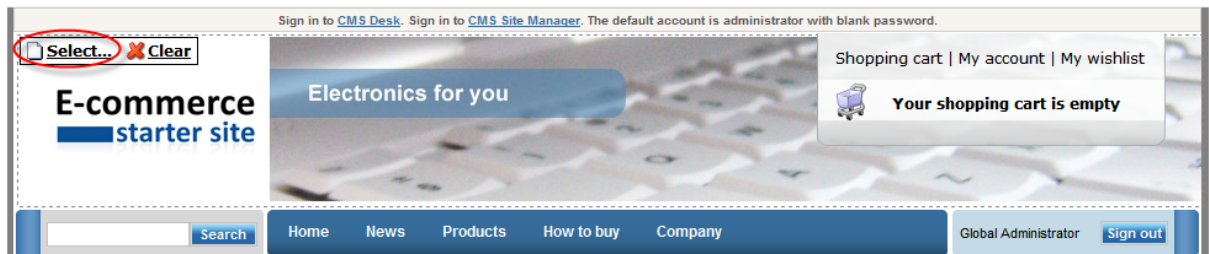

3. In the web page dialog, select **Files** in the content tree and click the **Upload file** button at the top-right.

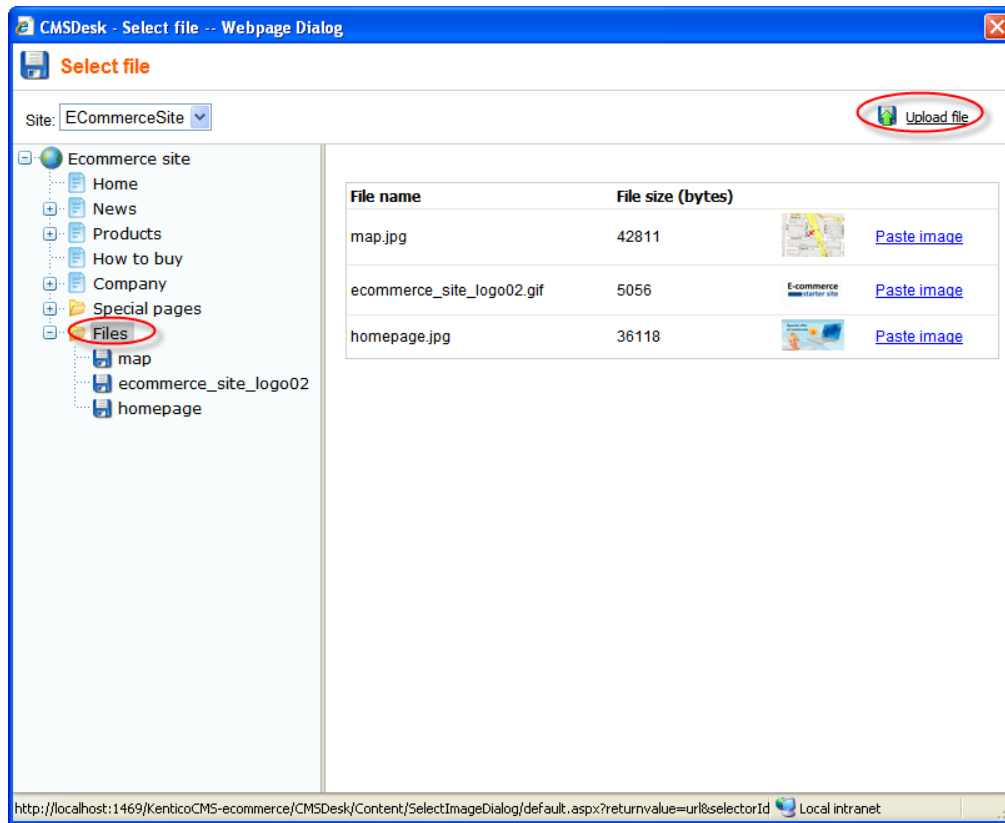

4. In the new dialog, click **Browse**.

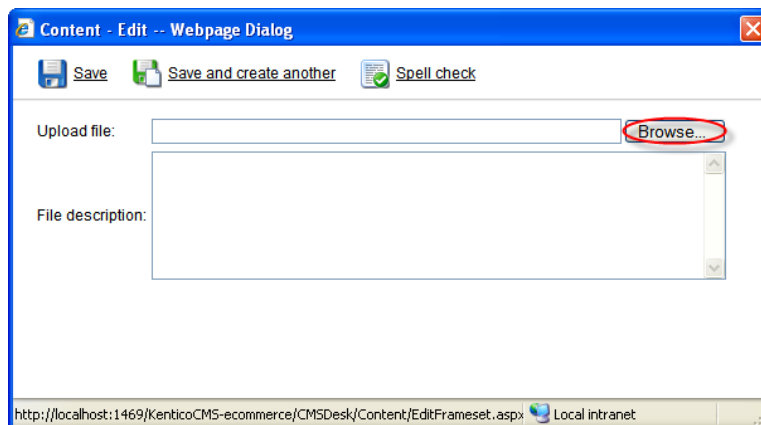

5. Find the image you want to upload and click **Open**.

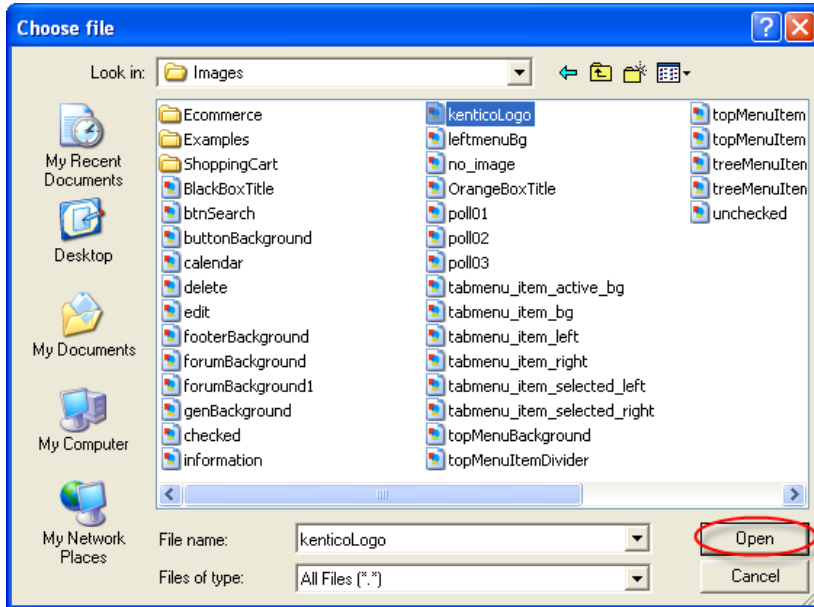

6. Click **Save**. Your new logo image is now ready to be posted on your web site.

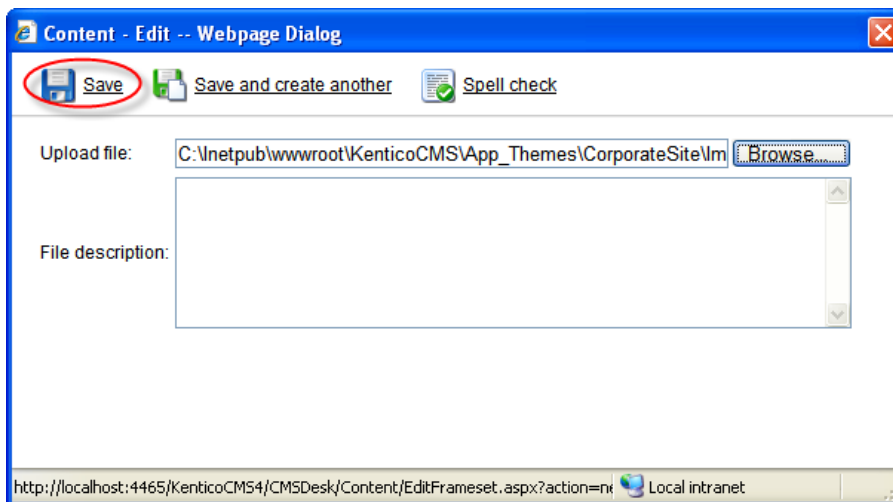

7. Click **Paste image** right above the picture.

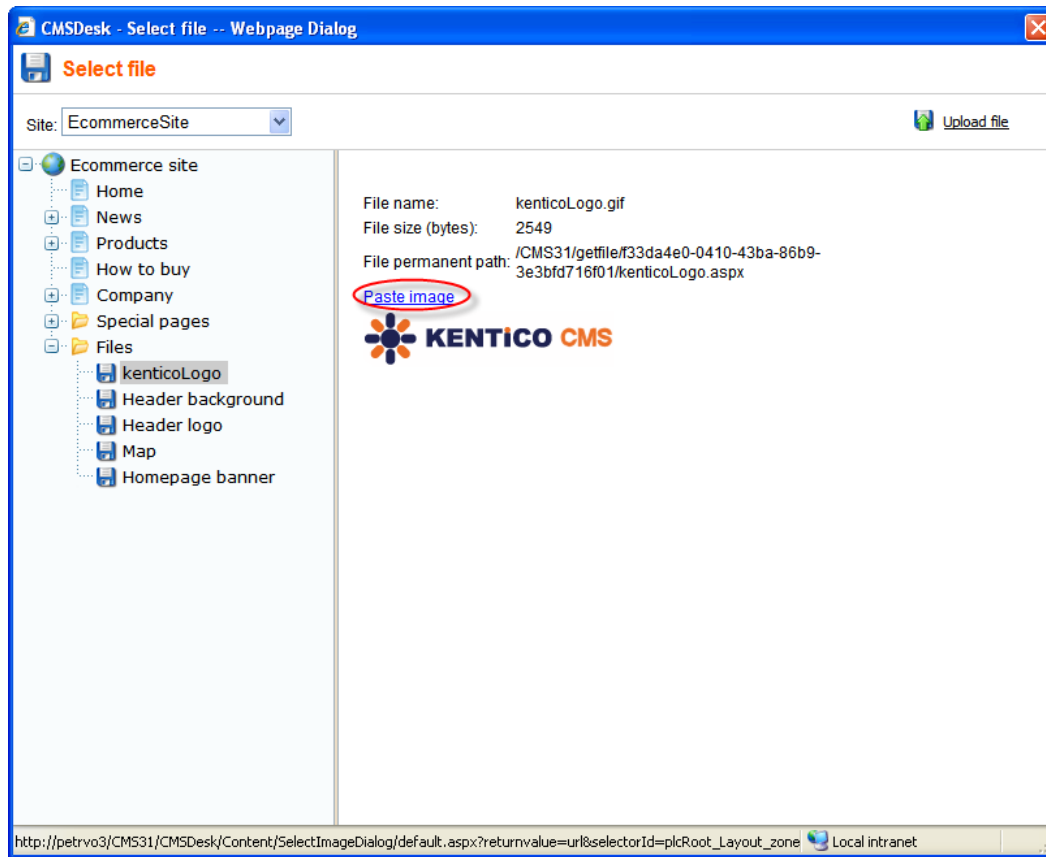

8. Now click **Save**.

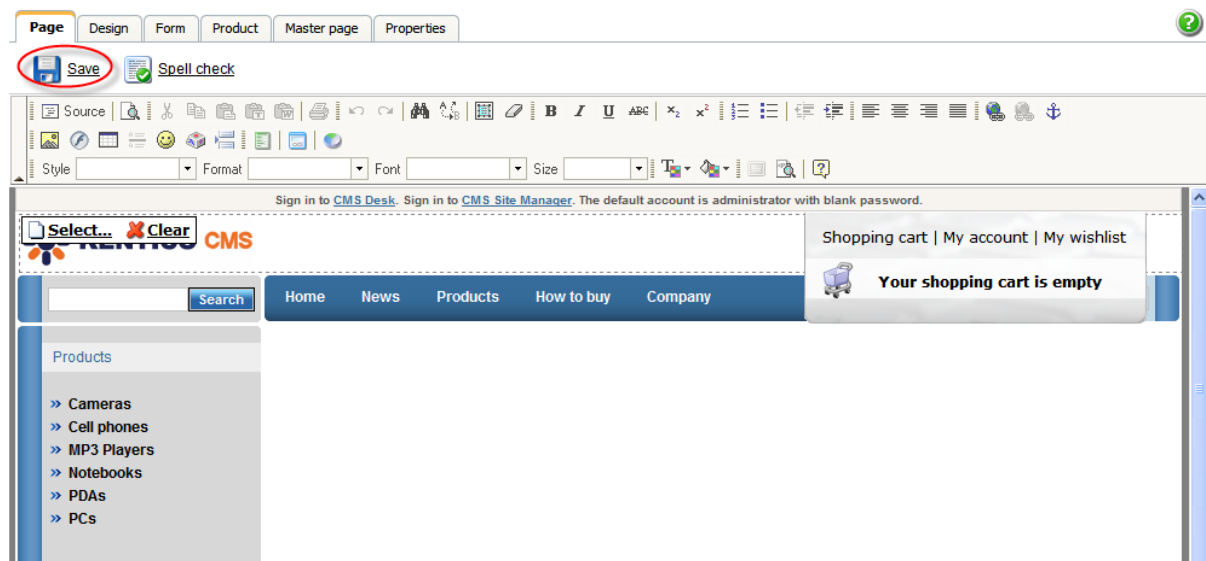

You've just publish a new logo on your web site.

Removing the log-on bar

1. Go to **CMS Desk** -> **Content** -> **Ecommerce site** and switch to the **Design** tab.

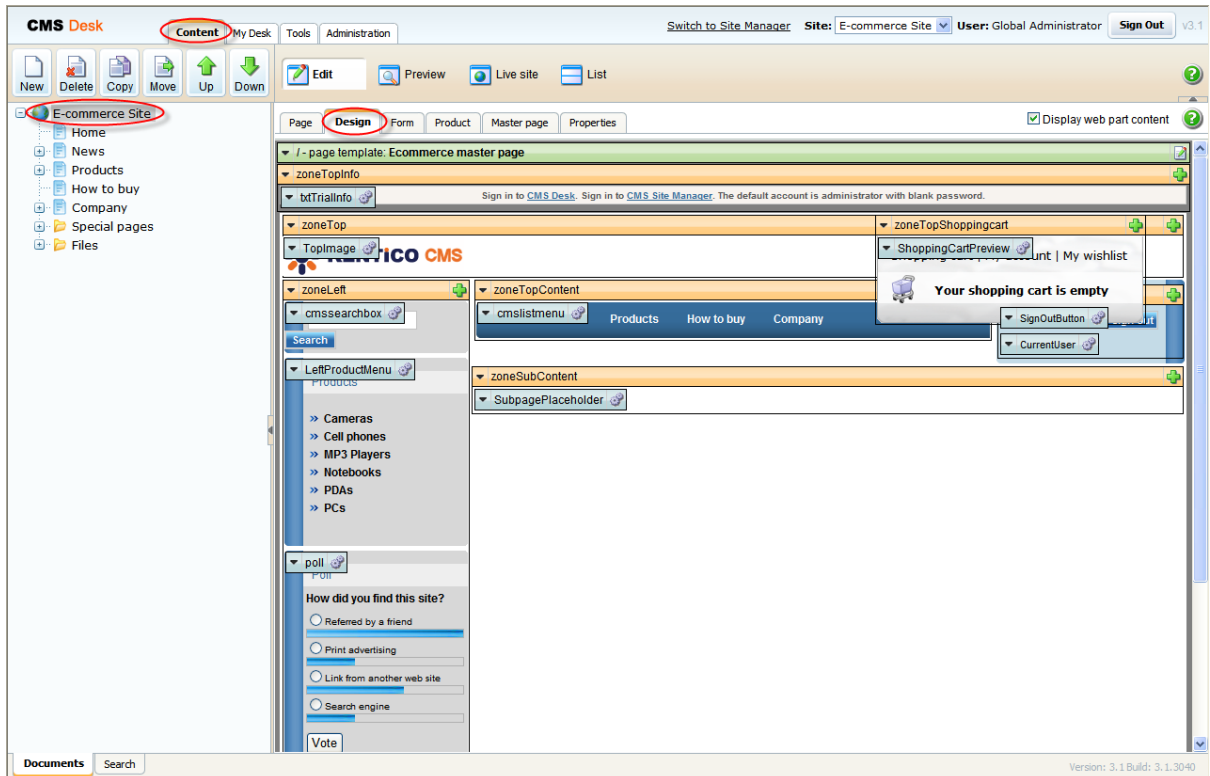

2. Right-clicked the **txtTrialInfo** webpart at the top-left and choose **Remove**.

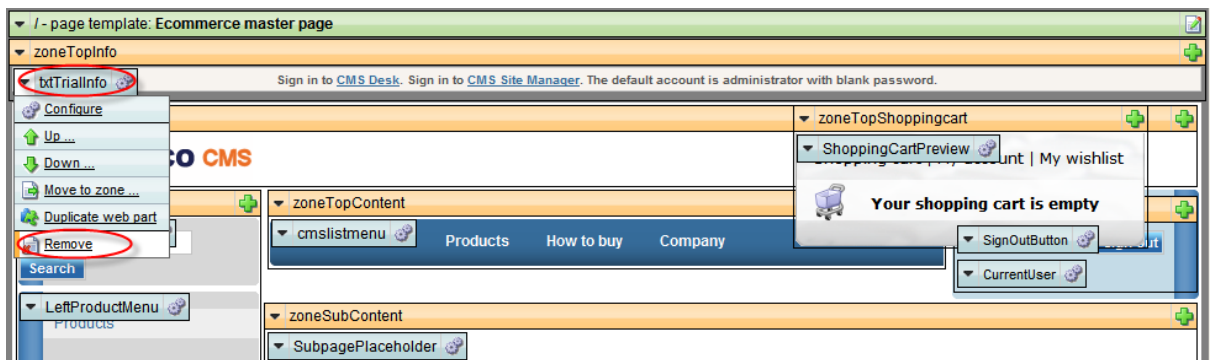

3. Click **Ok** to remove the bar from your website.

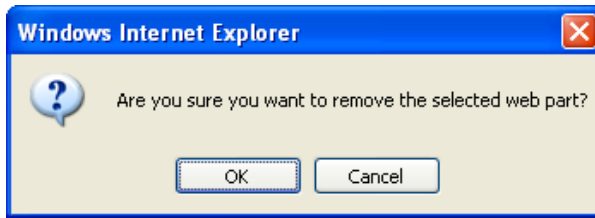

That's how you remove the signing-in bar from your web site.

Changing content of the menu

1. Go to **CMS Desk** -> **Content** -> **Ecommerce site** and switch to the **Design** tab.
2. Click the **Add web part** button from the drop-down menu in **zoneTopContent**.

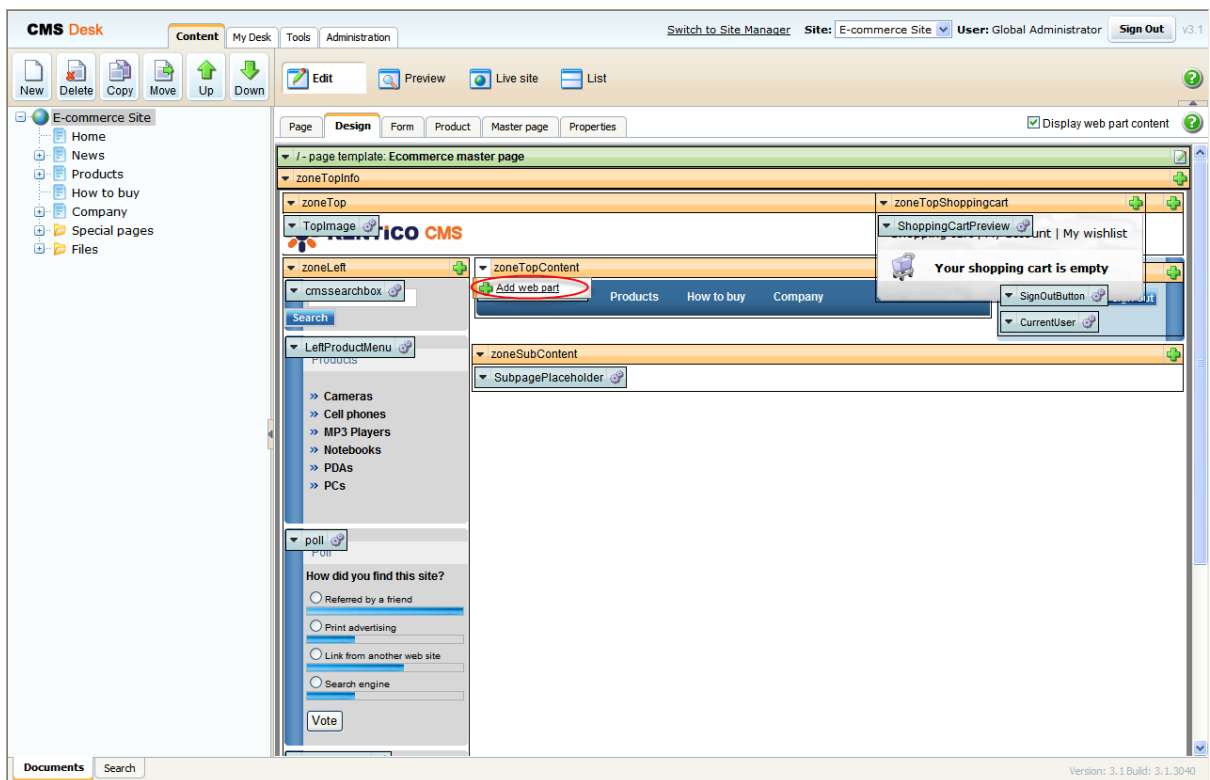

3. In the web page dialog, choose **Text -> Static text** and click **Ok**.

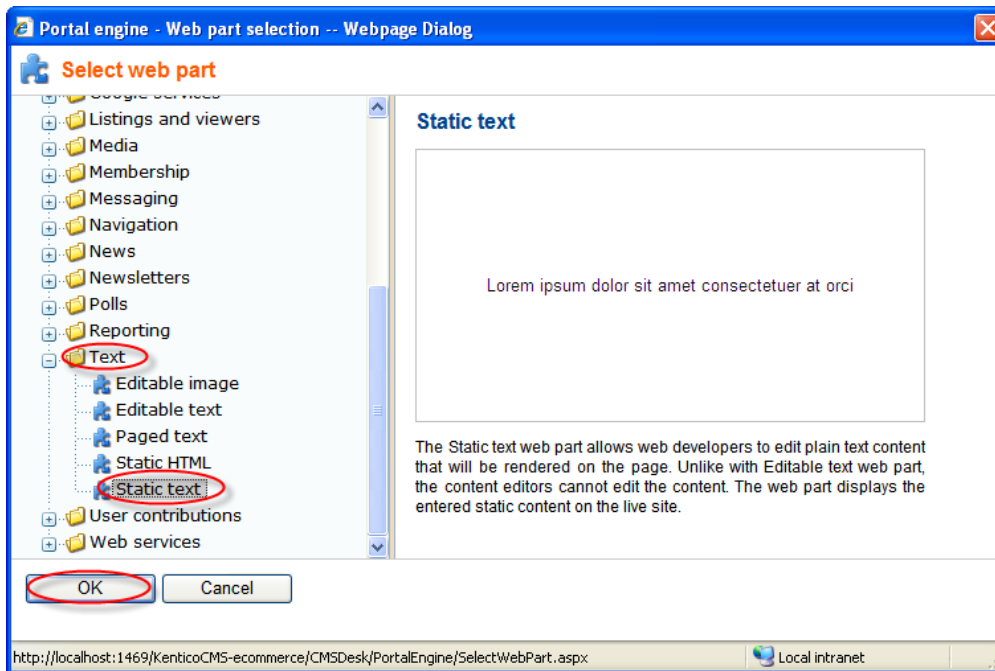

4. Enter *Season discount 10% on all products!* as **Text** and click **Ok**.

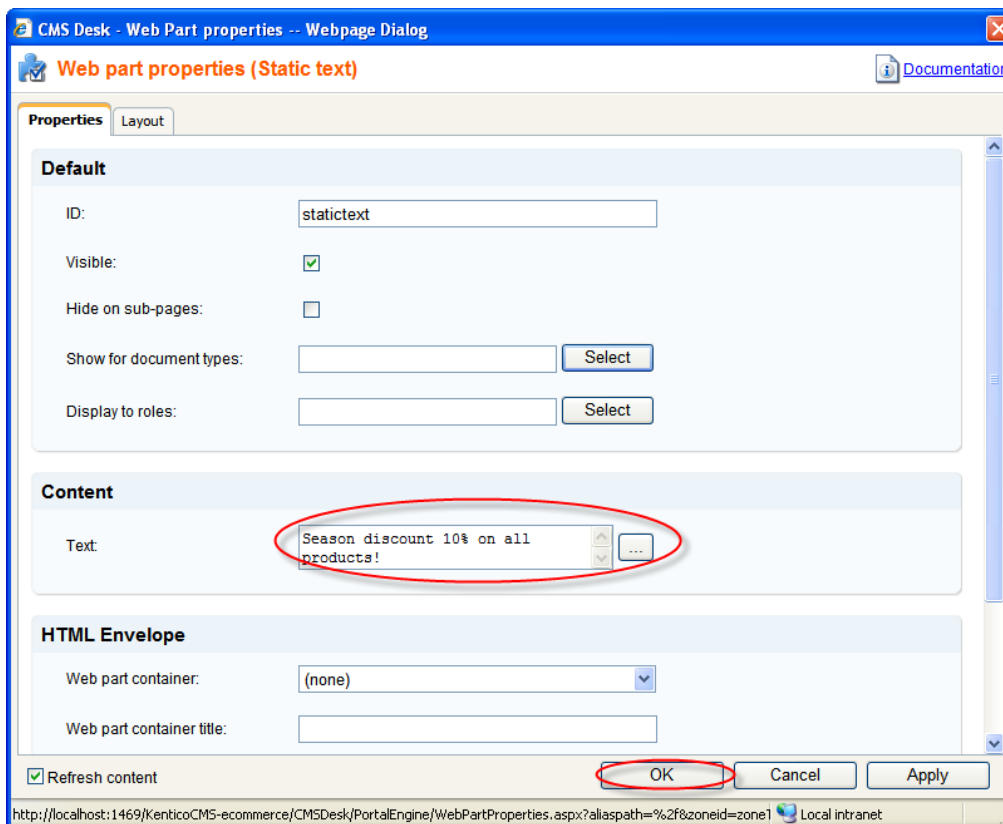

5. Now switch to the **Live site** viewing mode. You can see the new text bellow the main menu.

KENTICO CMS

Shopping cart | My account | My wishlist

Your shopping cart is empty

Season discount 10% on all products!

Welcome to E-commerce starter site

Special offer of notebooks

Random product

Latest news

2/13/2008

Dear customers, our shop now supports payments through PayPal. You can use this feature from this day.

2/13/2008

Dear customers, our company has become Apple partner so you can buy Apple's great products at our shop.

Newsletter subscription

E-mail:

OK



More information

Should you need more information about customizing your web site design, please refer to **Kentico CMS Developer's Guide**.

4.2 Changing colors using CSS styles

1. Go to **CMS Site Manager** -> **Development** -> **CSS stylesheets**.

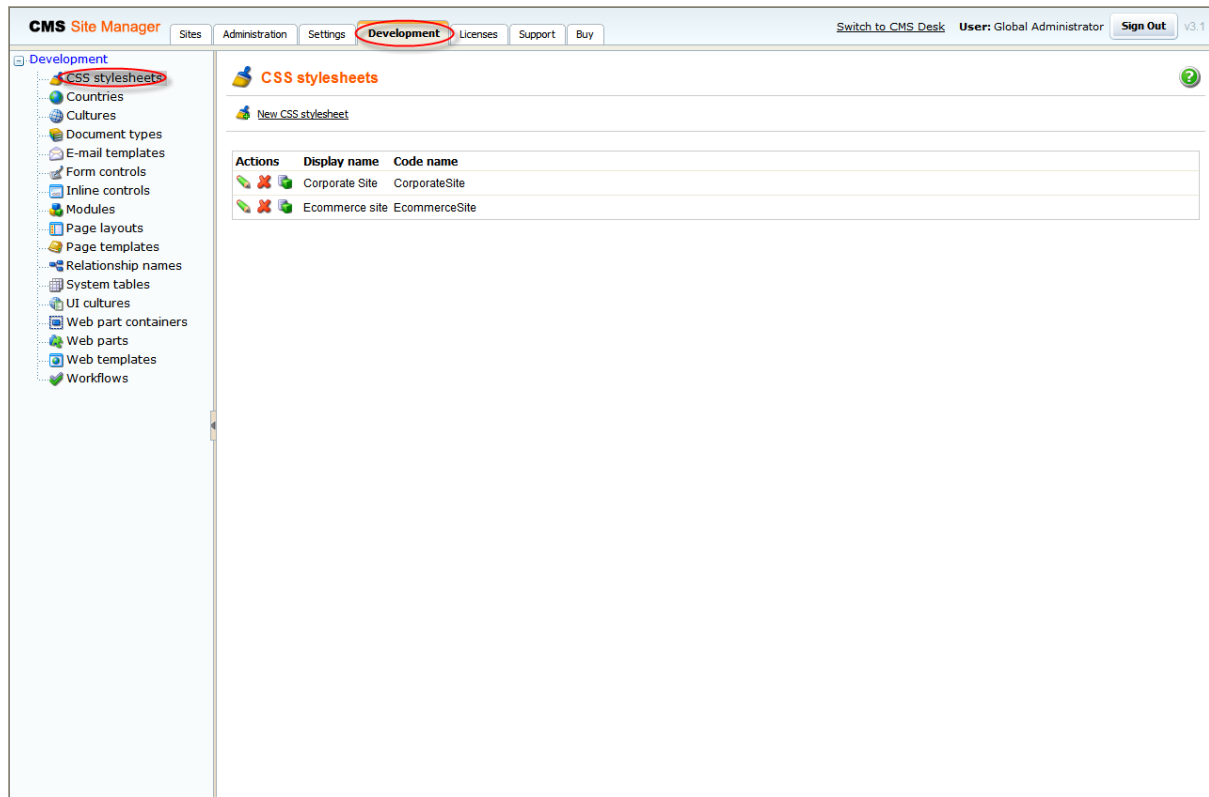

2. Click the **Edit** button next to the **Ecommerce site**.

Actions	Display name	Code name
  	Corporate Site	CorporateSite
  	Ecommerce site	EcommerceSite

3. In the **Stylesheet text** text box change background color of **body.LTR**, **body.RTL** from gray to yellow. Click **Save** at the top.



Check out to file

Check out the stylesheet to file C:\inetpub\wwwroot\KenticoCMS-e-commerce\CMSCSSStylesheets\EcommerceSite.css to edit the stylesheet externally.

Stylesheet display name:

Stylesheet code name:

Stylesheet text:

```

/*#Main styles#*/
body
{
    font-family: Arial;
    font-size: 12px;
}
body.LTR, body.RTL
{
    background: yellow;
}
a
{
    color: #356B99;
}
a:hover
{
    text-decoration: none;
}
h1
{

```

Navigation menu:

- Boxes
 - Blue box left
 - Blue box right
- Company
- Main styles
- Menus
 - Left menu
 - Top menu
- News
- Newsletter subscription
- Other styles
- Polls
- Products
 - Random product
 - Random product right column
 - Random product with status
- Search
 - Search box
 - Shopping cart item selector
 - Shopping cart preview
 - ShoppingCart
 - Sign out and user name box
- Tab menu
 - Sub menu

4. Go to **CMS Desk** and switch to the **Preview** mode. You can see that the background of the E-commerce web site is yellow.

The screenshot shows the CMS Desk interface with the following elements:

- Top Bar:** CMS Desk, Content, My Desk, Tools, Administration. Site: Ecommerce site, User: Global Administrator, Sign Out.
- Toolbar:** New, Delete, Copy, Move, Up, Down, Edit, Preview, Live site, List.
- Left Navigation:** Ecommerce site, Home, News, Products, How to buy, Company, Special pages, Files.
- Main Content Area:**
 - Sign in to CMS Desk, Sign in to CMS Site Manager. The default account is administrator with blank password.
 - KENTICO CMS logo and "Electronics for you" banner.
 - Shopping cart | My account | My wishlist. Total price: \$ 5211.00.
 - Navigation: Home, News, Products, How to buy, Company. administrator | Sign out.
 - Season discount 10% on all products!
 - Welcome to E-commerce starter site.
 - Special offer of notebooks (with laptop image).
 - Random product: Sony Ericsson W800.
 - Latest news:
 - 2/13/2008: Dear customers, our shop now supports payments through PayPal. You can use this feature from this day.
 - 2/13/2008: Dear customers, our company has become Apple partner so you can buy.
- Bottom Bar:** Documents, Search, Version: 3.1 Build: 3.1.2998.

Part

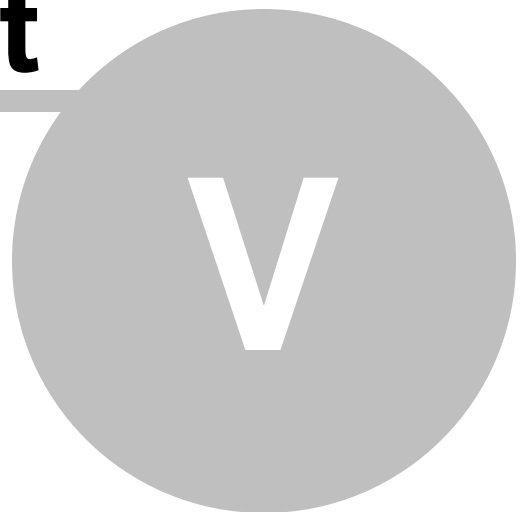

Integration with your existing Kentico CMS web site

5 Integration with your existing Kentico CMS web site

5.1 Overview

The e-commerce module provides several web parts that allow you to integrate it into your web site:

- **Shopping cart** - displays the shopping cart content and ensures the check-out process. For more info please see the [Shopping cart](#) chapter.
- **Shopping cart preview** - displays the links to the shopping cart, to my account and to my wishlist and the total value of the shopping cart content. For more info please see the [Shopping cart preview](#) chapter.
- **My account** - displays the details of the current user, such as personal settings, addresses, orders, invoices and allows user to change the password. For more info please see the [My account](#) chapter.
- **Wishlist** - displays the wishlist of the currently logged-on user. For more info please see the [Wishlist](#) chapter.
- **Similar products by sale** - displays products which were purchased together with the current product by previous customers. For more info please see the [Similar products by sale](#) chapter.
- **Random products** - displays random N products that correspond to the criteria specify in the content filter. For more info please see the [Random products](#) chapter.
- **Product datalist** - display products based on their e-commerce product (SKU) properties instead of displaying the standard CMS documents.
- **Top N products by sales** - displays N best-selling products. For more info please see the [Top N products by sales](#) chapter.

These web parts can be used also as independent user controls placed on the ASPX pages.

How to organize the pages

A typical content tree structure of an e-commerce-enabled web site looks like this:

- **Home** (page)
- **Products** (page)
 - **Category 1** (page; contains Repeater or DataList web parts displaying products with links to shopping cart)
 - **Product 1** (product specification document; it's marked as a product)
 - **Product 2** (product specification document; it's marked as a product)
 - **Category 2** (page; contains Repeater or DataList web parts displaying products with links to shopping cart)
 - **Sub category 1** (page; contains Repeater or DataList web parts displaying products with links to shopping cart)
 - **Product 3** (product specification document; it's marked as a product)
 - **Product 4** (product specification document; it's marked as a product)
- **News** (page)
- **Special pages**
 - **Shopping Cart** (page; it contains the Shopping cart web part and can be configured to be hidden in the navigation and site map)
 - **My Account** (page; it contains the My account web part and can be configured to be hidden in the navigation and site map)

5.2 Web parts

5.2.1 My account

The **My account** web part displays the details of the current user, such as personal settings, addresses, orders, invoices and allows user to change the password.

The screenshot shows a web page for an e-commerce site. The main content area is titled "My Account" and contains a form for user details. The form fields are:

- First name: administrator
- Last name: administrator
- Company account:
- E-mail: admin@yourdomain.com
- Phone:
- Fax:
- Preferred currency: U.S. Dollar
- Preferred payment method: (none)
- Preferred shipping option: (none)
- Country/state: (none)

There is an "OK" button below the form. The page also features a navigation menu with "Home", "News", "Products", "How to buy", and "Company". A shopping cart icon is visible in the top right corner, showing a total price of \$ 1068.00. The text "My account web part" is written in red at the bottom right of the screenshot.

You can modify the functionality of **My account** by setting following properties in the **Web Part properties dialog**:

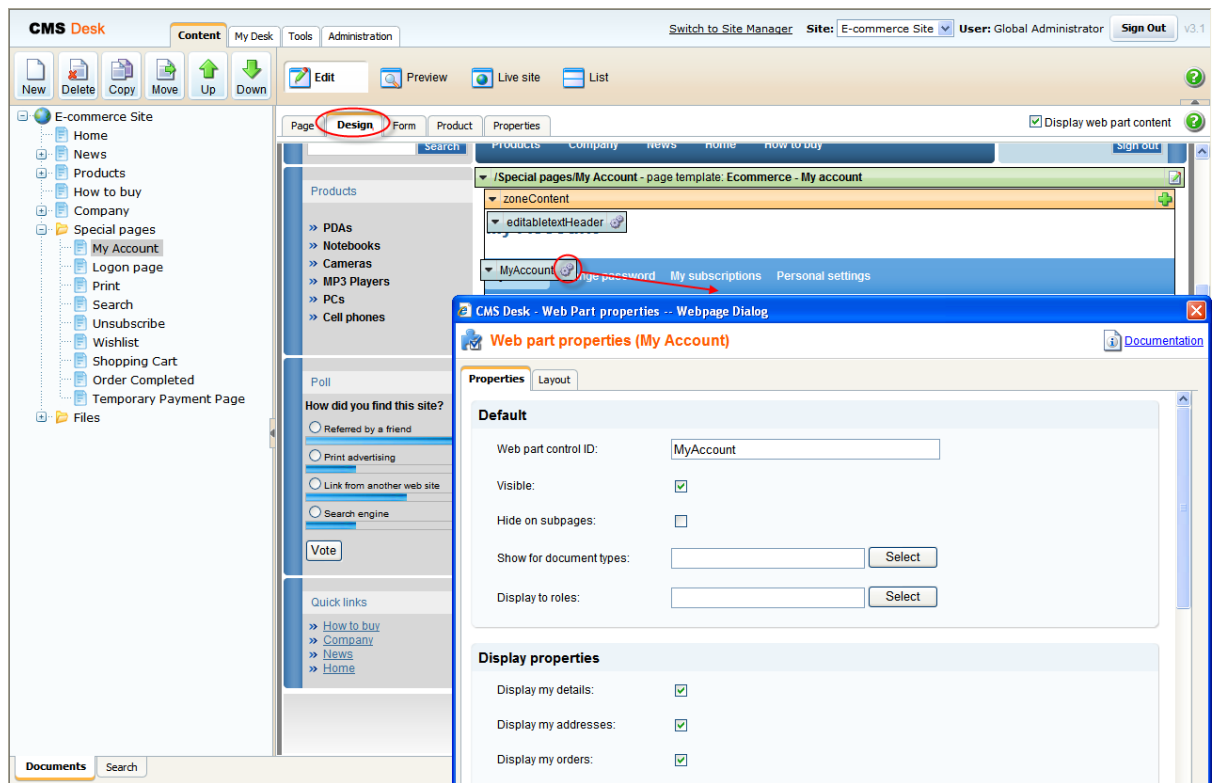

Display properties

Display my details	Indicates if My Details should be displayed to the user.
Display my addresses	Indicates if My Addresses should be displayed to the user.
Display my orders	Indicates if My Orders should be displayed to the user.
Display my credit	Indicates if My credit should be displayed to the user.
Display change password	Indicates if dialog for password reset should be displayed to the user.
Display my subscriptions	Indicates if My Subscriptions should be displayed to the user.
Display my messages	Indicates if My Messages should be displayed to the user.
Display my personal settings	Indicates if Personal settings should be displayed to the user.

Settings properties

Show order tracking number	Indicates if order tracking number should be visible in the order list.
Allow empty password	Indicates if empty password is allowed when changing the user password.
Tabs css class	CSS class used for the tabs.

5.2.2 Random products

The **Random products** web part displays products that correspond to the criteria specified in the content filter.

You can modify the functionality of **Random products** by setting properties in the **Web Part properties** dialog as you can see on the following image:

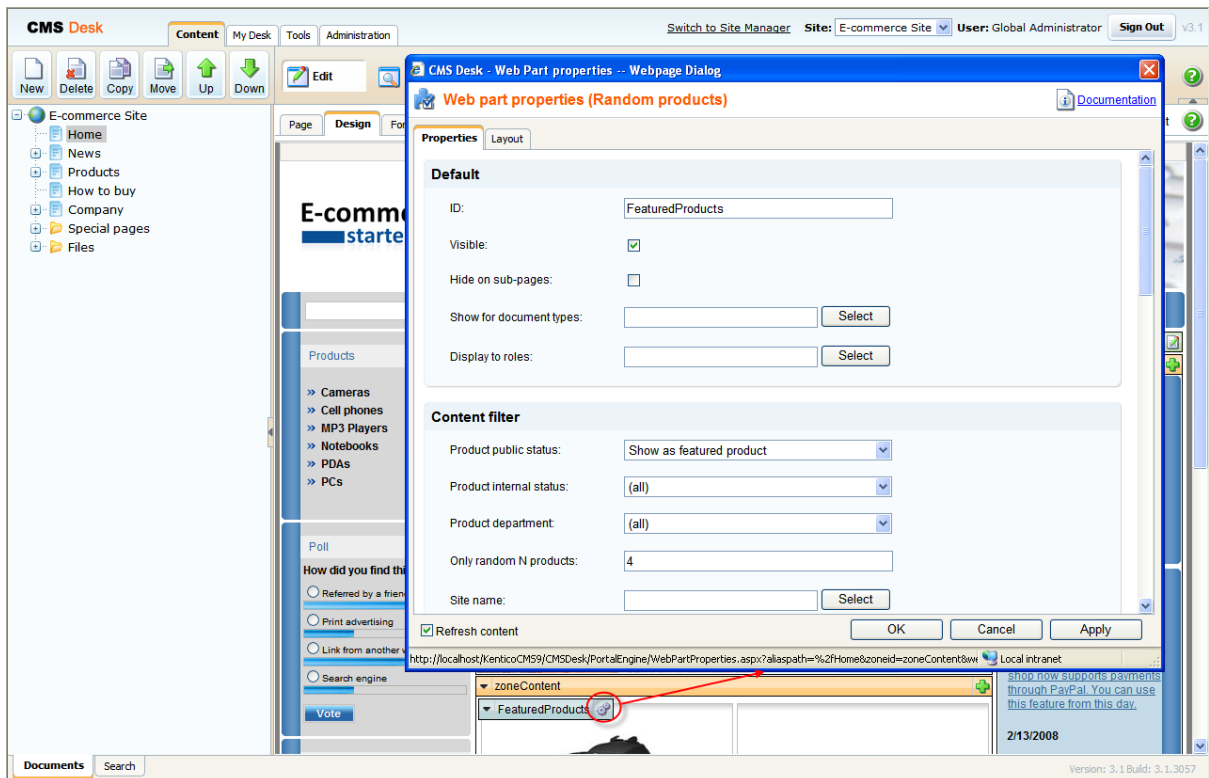

Content filter main properties

Product public status	Public status of products which should be displayed.
Product internal status	Internal status of products which should be displayed.
Product department	Department of products which should be displayed.
Only random N products	Indicates how many random products should be displayed. Don't put any value, if you want display all products.
Top N	The first N products selected according to the chosen criteria.
Path	Path of the documents to be displayed.
Document Types	Indicates from which document types should be products chosen.
WHERE Condition	WHERE part of the SELECT query.
ORDER BY expression	ORDER BY part of the SELECT query.

The **Random products** web part can be used in many different ways. All you have to do is to set the content filter accordingly to get rights products displayed.

1. Featured products on Home page

The screenshot displays the home page of an e-commerce site titled "E-commerce starter site". The page features a navigation menu with "Home", "News", "Products", "How to buy", and "Company". A search bar is located in the top left. The main content area includes a "Special offer of notebooks" banner with a laptop image and a woman's face. Below this, a "Random products web part" displays four featured products in a 2x2 grid:

- HP Pavilion dv6680: Our price: \$ 1290.00
- Nikon Coolpix S51: Our price: \$ 189.00
- Lenovo T61: Our price: \$ 999.00
- Toshiba Satellite Pro: Our price: \$ 1499.00

The right sidebar contains a shopping cart with a total price of \$ 378.00, a "Sign out" button for the administrator, a "Random product" section showing a Canon PowerShot A720 IS camera, a "Latest news" section with two news items dated 2/13/2008, and a "Newsletter subscription" form.

On the **Home** page, **Random products** is set to display the maximum of 4 random products that have the public status set to **Show as featured product**:

Only random N products: 4

The maximum of 4 random products is displayed.

Product public status: Show as featured product

Only products with the public status set to **Show as featured product** are displayed.

Transformation name: ecommerce.transformations.EcommerceSite_FeaturedProducts

The ecommerce.transformations.EcommerceSite_FeaturedProducts transformation used in the list view mode.

For description of how to display the given product as the featured product, please refer to the [Displaying featured products](#) chapter.

2. Similar products at the product detail

The screenshot displays a product detail page for a Motorola V3 RAZR. The page layout includes a header with navigation links (Home, News, Products, How to buy, Company) and a search bar. The main content area features the product name, a price of \$130.00, and a list of accessories (Car charger, Headset, Leather case). A 'Similar products' section is highlighted with a red box, showing two products: Nokia 6300 (\$129.00) and Sony Ericsson W900 (\$175.00). The page also includes a 'Description' section and a 'Newsletter subscription' form.

At the product detail, the given web part is set to display the maximum of 4 random products which have price similar to the currently chosen product and which are of the same type.

Show for document types: CMSProduct.Camera;CMSProduct.CellPhone;CMSProduct.Computer; CMSProduct.Laptop;CMSProduct.MediaPlayer;CMSProduct.PDA

Random product is displayed only in the given document types, therefore, at product detail. If a user switch to the product list, the given web part is hidden. If you add a new product type and you want it to be displayed with the **Random product** web part, you need to add your new product type into the **Show for document types** text box.

Only random N products: 4

The web part displays 4 random products at most, according to the filter conditions.

WHERE condition: (SKUPrice > {%SKUPrice%} * 0.6) AND (SKUPrice < {%SKUPrice%} * 1.4) AND (NodeSKUID <> {%NodeSKUID%})

Ensures that only products with the price similar to the currently chosen product are displayed.

Document types: {%ClassName%}

Ensures that only the products of the same type as the currently chosen product are displayed.

For more details about the context macros please refer to the **Appendix A - Macro expressions** chapter in **Kentico CMS Developer's Guide**.

Transformation name: Ecommerce.Transformations.EcommerceSite_RandomProducts

The `Ecommerce.Transformations.EcommerceSite_RandomProducts` transformation used in the list view mode.

For instance, if the currently chosen product is type of `cmsproduct.cellphone` with `SKUPrice` set to 100, the **Random product** web part displays the maximum of 4 products, type of `cmsproduct.cellphone` with `SKUPrice` between 60 and 140.

3. Recommended products on News page and Home page

On the **News** page, the given web part is set to display 4 random products, regardless of their type.

The screenshot shows an e-commerce website interface. At the top, there's a navigation bar with 'Home', 'News', 'Products', 'How to buy', and 'Company'. A search bar is on the left. The main content area is titled 'News' and contains several news items: 'PayPal payment support', 'Apple products', and 'Our new e-shop launched'. On the right side, there's a 'Recommended products' section with four items: 'Acer configurator \$ 899.00', 'Asus A639 \$ 470.00', 'Pentax K100 \$ 804.00', and 'Samsung SGH I620 \$ 650.00'. Below this is a 'Random products' section, which is highlighted with a red box. The 'Random products' section contains the same four items as the 'Recommended products' section. At the bottom, there's a 'Latest news' section with two news items dated 2/13/2008. A 'Newsletter subscription' form is at the very bottom.

In this case, the **Only random N products** property is set to **4** and the **Transformation name** property is set to `toecommerce.transformations.Ecommerce_RandomProducts`.

On the **Home** page, the given web part is set to display 1 random product, regardless of its type.

The screenshot displays the 'E-commerce starter site' home page. At the top, there is a navigation bar with links for 'Home', 'News', 'Products', 'How to buy', and 'Company'. A search bar is located on the left. The main content area features a 'Special offer of notebooks' banner with a laptop image and a woman's face. Below the banner, there are two product cards: 'Emgeton M7 Cult' priced at \$215.00 and 'iPod Nano' priced at \$199.00. On the right side, a 'Recommended product' section is highlighted with a red box, showing an 'HP configurator' under the heading 'Random products'. The page also includes a poll titled 'How did you find this site?', quick links, and a newsletter subscription form.

In this case, the **Only random N products** property is set to 1. The **Transformation name** property is set to `commerce.transformations.Ecommerce_RandomProduct`.

5.2.3 Shopping cart

The **Shopping cart** web part displays the shopping cart content and ensures the check-out process.

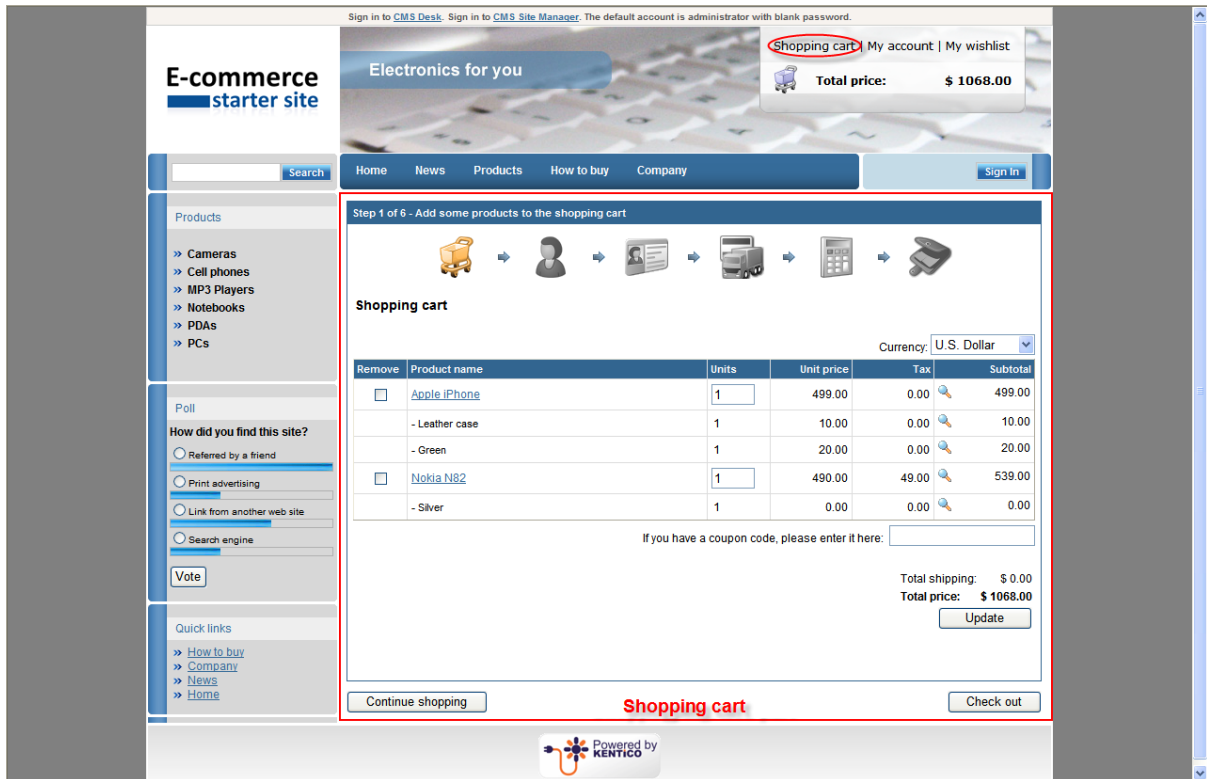

You can modify the functionality of **Shopping cart** by setting following properties in the **Web Part properties dialog**:

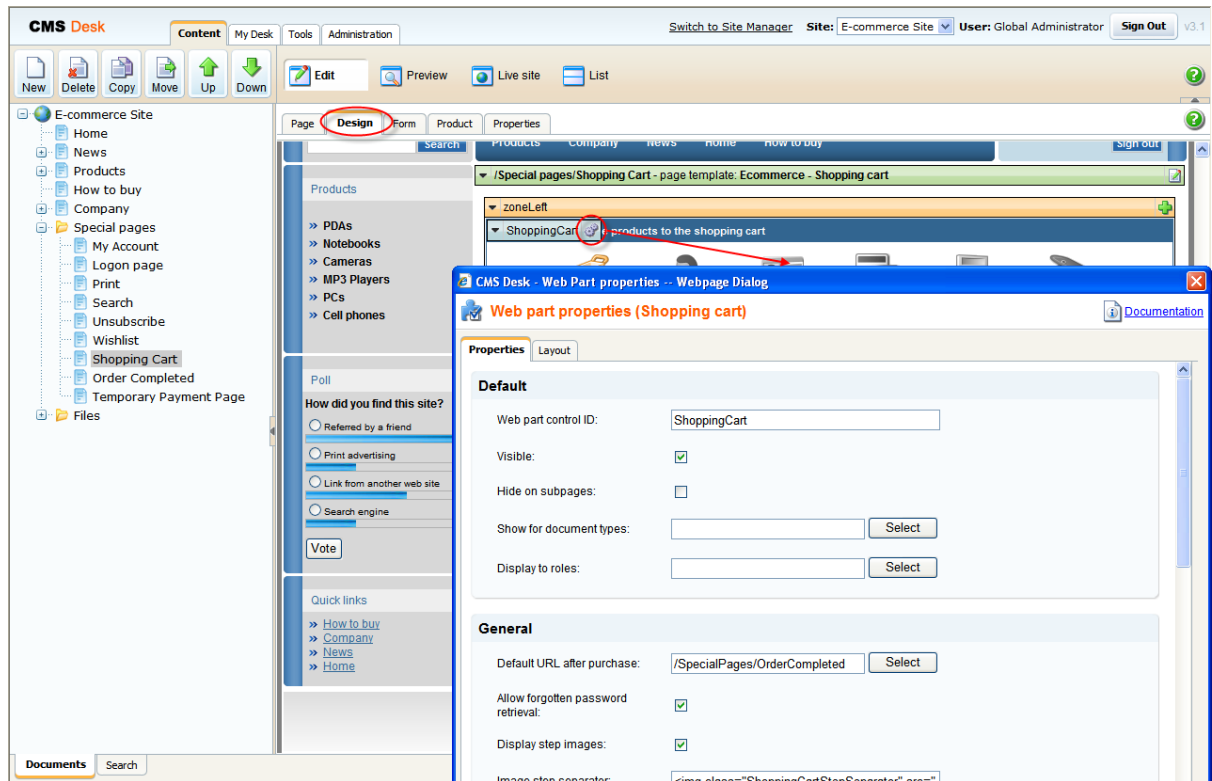

General properties

Default URL after purchase	Default page where the user should be redirected if no URL is specified for the given payment option.
Allow forgotten password retrieval	Indicates if the forgotten password can be retrieved in the Shopping Cart sign-in dialog.
Display step images	Indicates if the images should be displayed during the order process
Image step separator	The separator displayed between shopping progress images.
Enable product price detail	Indicates if the link to the price detail page should be displayed.
Required fields mark	HTML code for the required fields mark, e.g. asterisk (*)

Registration form properties

Assign user to role	If you enter some role to this field, the user will be automatically assigned to it after registration.
Notify administrator about new registrations to e-mail address	Enter administrator's e-mail address if you want to send registration notification message.

Conversion tracking properties

Registration conversion name	Name of the registration conversion used in web analytics.
Order conversion name	Name of the order conversion used in web analytics.

5.2.4 Shopping cart preview

The **Shopping cart preview** web part displays the links to the shopping cart, to my account and to my wishlist and the total value of the shopping cart content.

The screenshot displays an E-commerce starter site with the following elements:

- Header:** "E-commerce starter site" logo, "Electronics for you" banner, and a shopping cart preview box showing "Shopping cart | My account | My wishlist" with a total price of \$699.00 and a "Shopping cart preview" link.
- Navigation:** Home, News, Products, How to buy, Company, and Sign In links.
- Left Sidebar:**
 - Products: Cameras, Cell phones, MP3 Players, Notebooks, PDAs, PCs.
 - Poll: "How did you find this site?" with options: Referred by a friend, Print advertising, Link from another web site, Search engine.
 - Quick links: How to buy, Company, News, Home.
- Main Content:**
 - Welcome to E-commerce starter site.
 - Special offer of notebooks with a laptop image and a flame icon.
 - Product listings:
 - Lenovo T61: Our price: \$999.00
 - Toshiba Satellite Pro: Our price: \$1499.00
- Right Sidebar:**
 - Random product: HP Pavilion PC a6140.
 - Latest news:
 - 2/13/2008: Dear customers, our shop now supports payments through PayPal. You can use this feature from this day.
 - 2/13/2008: Dear customers, our company has become Apple partner so you can buy Apple's great products at our shop.
 - Newsletter subscription: E-mail field and OK button.

You can modify the functionality of **Shopping cart preview** by setting following properties in the **Web Part properties** dialog:

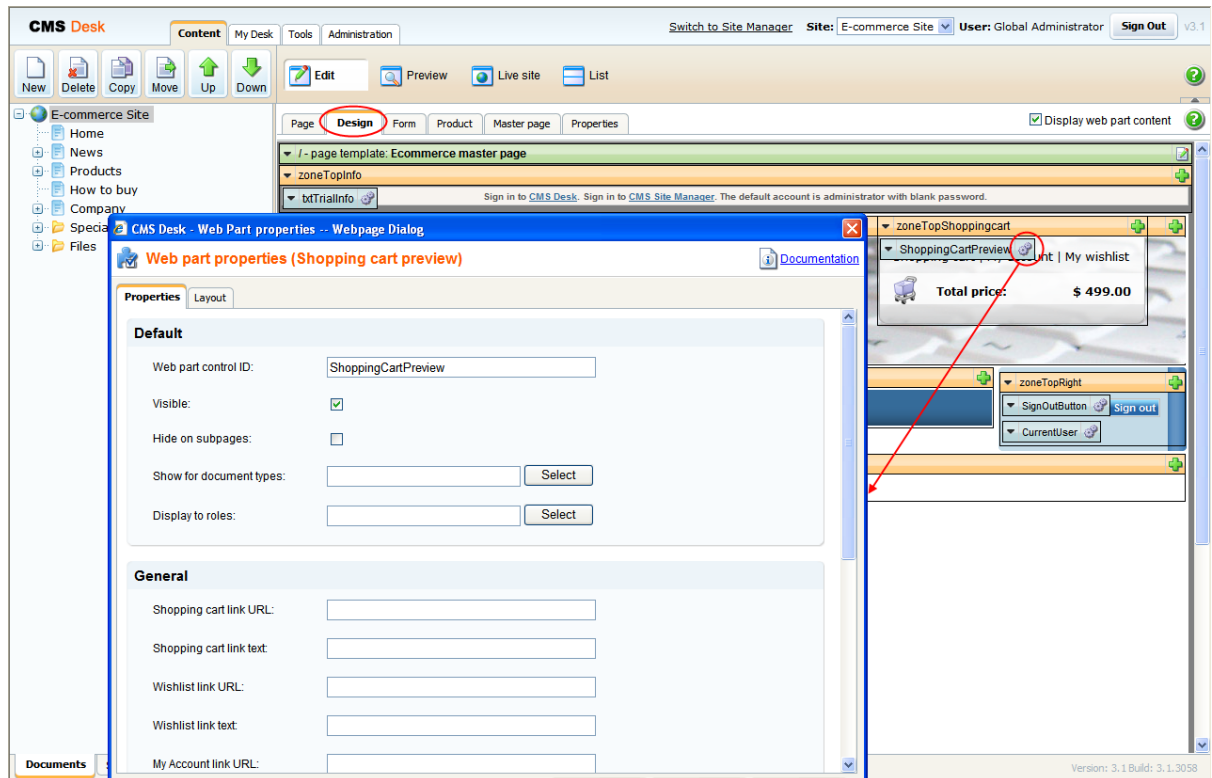

General properties

Shopping cart link URL	URL of the page with Shopping cart web part. If not set, the default URL from the Site Manager -> Manager -> Settings -> E-commerce -> Shopping cart URL settings is used.
Shopping cart link text	Text of the link to the Shopping cart page.
Wishlist link URL	URL of the page with Wishlist web part. If not set, the default URL from the Site Manager -> Settings -> E-commerce -> Wishlist URL settings is used.
Wishlist link text	The link text for the Wishlist URL.
My Account link URL	URL of the page with My Account web part. If not set, the default URL from the Site Manager -> Settings -> E-commerce -> My account URL settings is used.
MyAccount link text	Text of the link to the My Account page.
Total price text	Text displayed next to the total price.
Show total price row	Indicates if total price row should be displayed.

5.2.5 Similar products by sale

The **Similar products by sale** web part displays N products which other customers buy with the chosen product most commonly. By default, 4 products are displayed at most.

For instance, if a first customer buys the product A together with product B and C, a second customer is in the product A detailed displayed with the product B and C which have been purchased together with the product A by the first customer.

The screenshot displays an e-commerce website interface. At the top, there is a navigation bar with 'Home', 'News', 'Products', 'How to buy', and 'Company'. A search bar is located on the left. The main content area shows the product page for 'Samsung SGH i620'. The product image is on the left, and its specifications are listed on the right. Below the specifications, the price is shown as '\$ 650.00'. A dropdown menu for 'Color' is set to 'Red (+ \$ 0.00)'. There are buttons for 'Add to wishlist' and 'Add to cart'. A 'Description' section at the bottom provides details about the phone's features. On the right side, there is a 'Similar products' section with two items: 'Apple iPhone \$ 499.00' and 'Nokia N82 \$ 490.00'. Below this, a section titled 'Customers also buy' is highlighted with a red box, showing 'Apple iPhone \$ 499.00' with the text 'Similar products by sale' in red. The bottom right corner features a 'Latest news' section with two news items dated '2/13/2008'.

Sign in to [CMS Desk](#). Sign in to [CMS Site Manager](#). The default account is administrator with blank password.

E-commerce starter site

Electronics for you

Shopping cart | My account | My wishlist

Your shopping cart is empty

Search

Home News Products How to buy Company

Products

Products / Cell phones / Samsung SGH i620

Print

Samsung SGH i620

Parameters:

Width:	94.9
Height:	59.3
Weight(g):	126
Display type:	TFT 65M colors
Display resolution:	320 x 240
Bluetooth:	yes
IrDA:	no
GPRS:	yes
EDGE:	yes
HSCSD:	no
3G:	yes
Wi-Fi:	no
Java:	yes
Built-in camera:	yes
MP3 player:	yes

Our price: **\$ 650.00**

Samsung SGH i620 - Color

Red (+ \$ 0.00)

Add to wishlist 1 Add to cart

Description

Weighing just 126g, the Samsung SGH-i620 is a light weight smartphone running Windows Mobile Standard (WMB), with great communication options, slide down QWERTY keyboard and 2 Mega Pixel camera.

Similar products

- Apple iPhone \$ 499.00
- Nokia N82 \$ 490.00

Customers also buy

- Apple iPhone \$ 499.00

Similar products by sale

Latest news

2/13/2008

Dear customers, our shop now supports payments through PayPal. You can use this feature from this day.

2/13/2008

Dear customers, our company has become Apple partner so you can buy Apple's great products at our shop.

You can modify the functionality of **Similar products by sale** by setting following properties in the **Web Part properties** dialog:

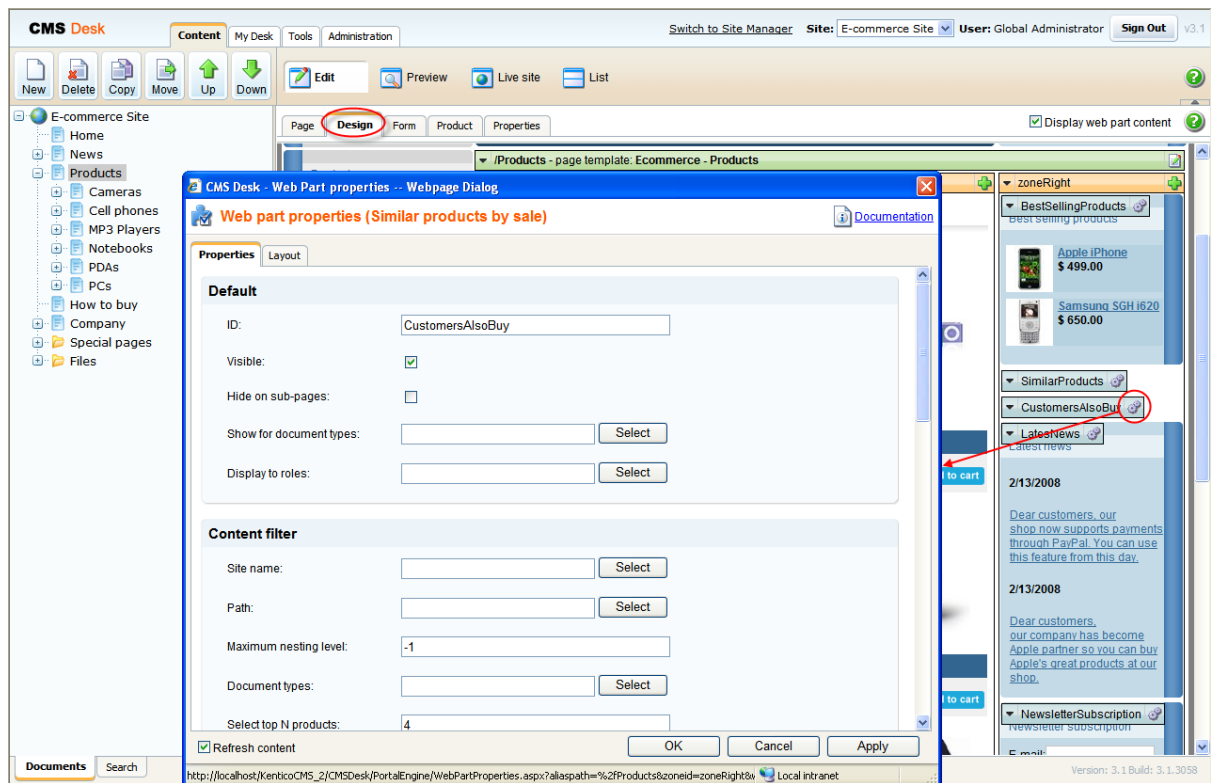

Content filter main properties

Path	Path of the documents to be displayed.
Document types	Types of documents that should be displayed, separated with a semicolon (;).
Select top N products	Selects only top N products. If blank, all items are selected..
WHERE condition	WHERE part of the SELECT query.
ORDER BY expression	ORDER BY part of the SELECT query.

Transformations main properties

Transformation name	Transformation used in the list view mode.
----------------------------	--

5.2.6 Top N products by sale

The **Top N products by sale** web part displays the top N best-selling products. The best-selling products are chosen according to the frequency of their occurrence in customers' orders, not according to the total volume of sales.

For instance, if a customer buys 10 items of the product A and 2 items of the product B and a second customer buys 4 items of the product B, the product B is evaluated as the best-selling.

You can modify the functionality of **Top N products by sale** by setting following properties in the **Web Part properties** dialog:

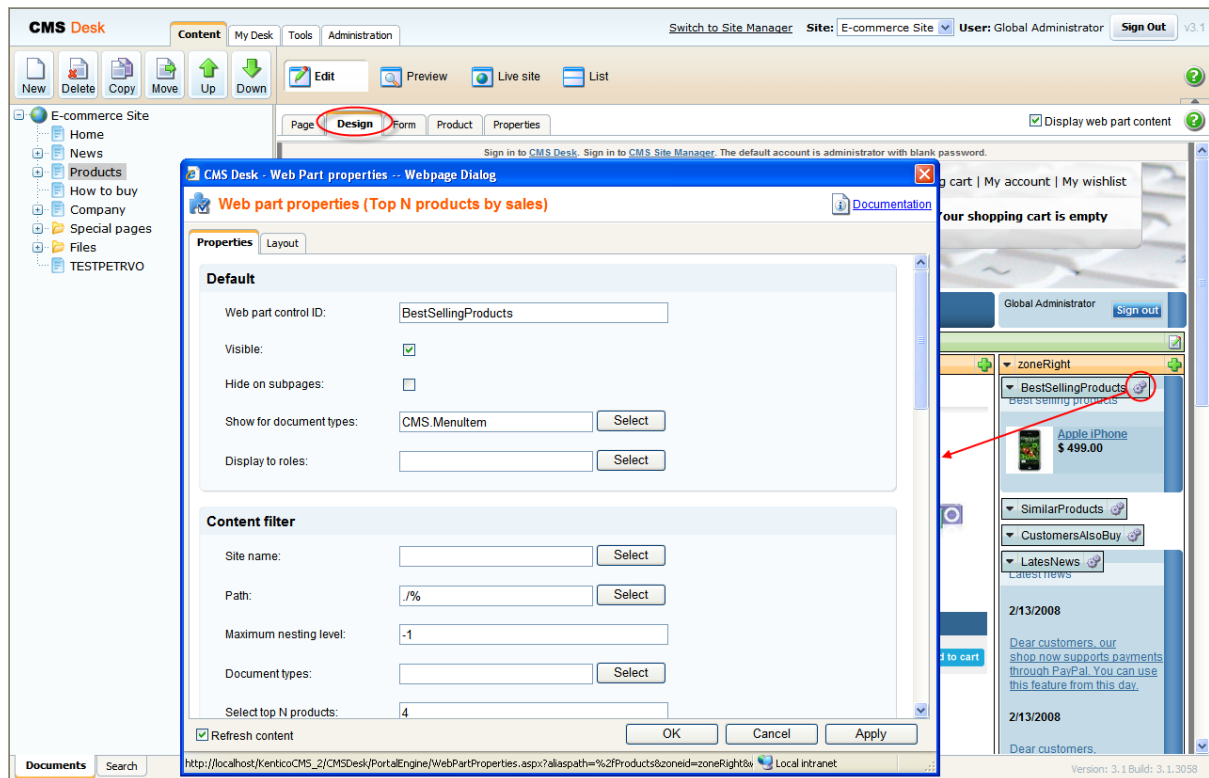

Content filter main properties

Path	Path of the documents to be displayed.
Document types	Types of documents that should be displayed, separated with a semicolon (;).
Select top N products	Indicates how many best-selling products should be displayed.
WHERE condition	WHERE part of the SELECT query.
ORDER BY expression	ORDER BY part of the SELECT query.

Transformations main properties

Transformation name	Transformation used in the list view mode.
---------------------	--

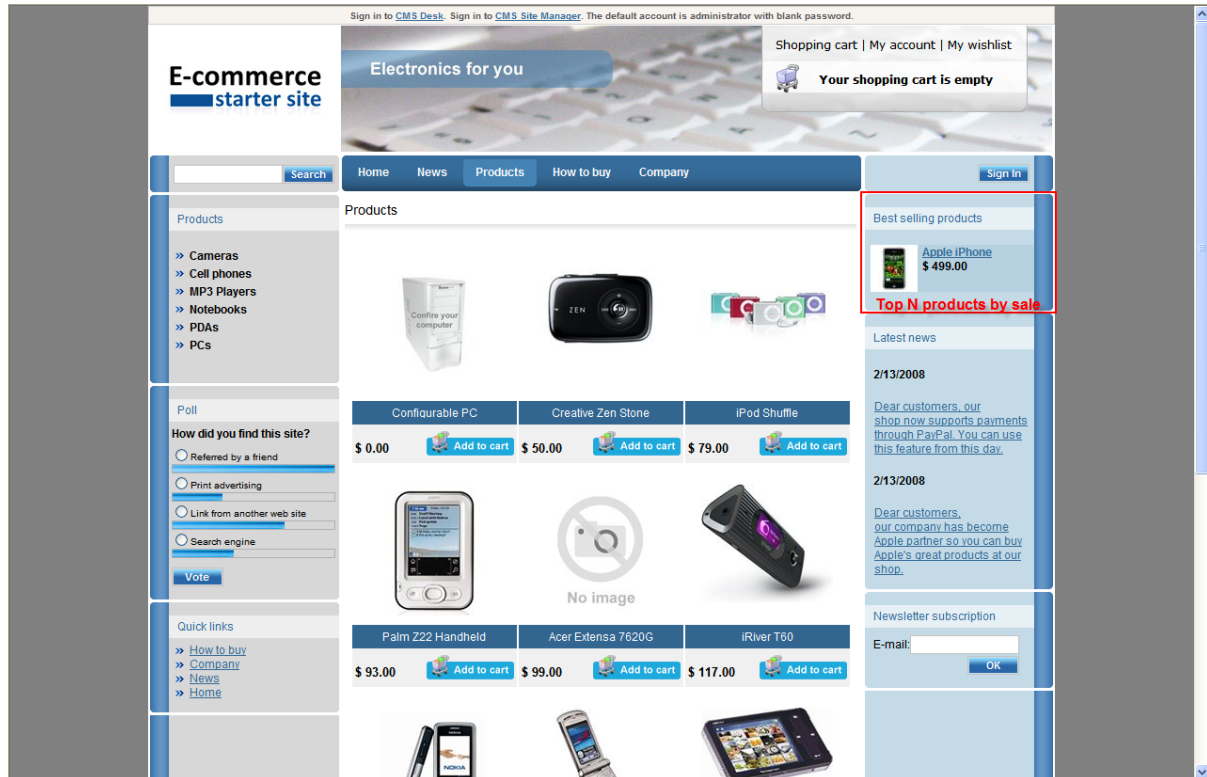

On the sample E-commerce site at the **Products** page, the **Top N products by sale** web part is configured to display 4 products at most from the currently chosen products category. Its properties are set to the following values:

Show for document types: CMS.Menuitem

The given web part is displayed only in **CMS.Menuitem** documents. On the sample **E-commerce site**, the given web part is therefore displayed only in the list of products of a chosen category and is hidden in the product detail.

Path: ./%

Only best-selling products from the currently selected category are displayed. For more information about the path expressions please refer to Appendix B - Path expressions chapter in **Kentico CMS Developer's Guide**.

Select top N products: 4

The maximum of 4 best-selling products is displayed.

5.2.7 Wishlist

The **Wishlist** web part displays the wishlist of the currently logged-on user.

Sign in to [CMS Desk](#); Sign in to [CMS Site Manager](#); The default account is administrator with blank password.

E-commerce starter site

Electronics for you

Shopping cart | My account | **My wishlist**

Total price: \$ 378.00

Home News Products How to buy Company administrator Sign out

Products

- » Cameras
- » Cell phones
- » MP3 Players
- » Notebooks
- » PDAs
- » PCs

Poll

How did you find this site?

Referred by a friend

Print advertising

Link from another web site

Search engine

Vote

Quick links

- » [How to buy](#)
- » [Company](#)
- » [News](#)
- » [Home](#)

Wishlist

Apple iPhone

iPhone is a revolutionary new mobile phone that allows you to make a call by simply tapping a name or number in your address book, a favorites list, or a call log. It also automatically syncs all your contacts from a Windows PC, Mac, or Internet service. And it lets you select and listen to voicemail messages in whatever order you want—just like email.

our price: \$ 499.00

[Remove from wishlist](#) [Add to shopping cart](#)

Acer Aspire 3105WLMi

Great choice for mobile professionals who like to play as hard as they work—and who have an eye on the budget. Acer's acclaimed Folio design features chic lines, smooth curves, and a cool metallic sheen, while its slim-and-light form factor facilitates excellent mobility, while front-access ports and controls make connecting to a network convenient.

our price: \$ 941.00

[Remove from wishlist](#) [Add to shopping cart](#)

iRiver T60

The ultra-portable T60 delivers exceptional sound quality in a uniquely durable and sporty design. The T60 includes everything contemporary customers expect from an MP3 player, including such extras as a 65,000-color LCD screen and a built-in digital FM radio. Users can load BMP picture files onto the T60 to share with friends on the T60's robust screen. In addition to supporting MP3, WMA, ASF, and OGG Q10 music files, the T10 is PlaysForSure verified to support subscription-based music download services, giving you instant, affordable access to millions of songs right out of the box. When it's time to transfer files onto the T10, USB 2.0 connectivity and Windows Media Player 10 compatibility make file transferring a snap. The T60 also supports a mass storage mode.

Other design features include a voice recorder—which is a great feature to record important class lectures or business meetings—an alarm clock, an integrated sport clip, and an easy-to-use jog dial user interface. With 4 GB of internal Flash memory, the T10 supports up to 136 hours of audio playback. Powered by one AAA battery, the T10 is capable of producing 19 hours of audio playback. Compatible with Windows and Mac operating systems, the T10 measures 2.57 by 1.08 by 0.87 inches, weighs just .85 ounce, and comes backed by a 1-year limited manufacturer's warranty.

our price: \$ 117.00

[Remove from wishlist](#) [Add to shopping cart](#)

[Continue shopping](#)

My wishlist web part

Powered by **KENTICO**

You can modify the functionality of **My wishlist** by setting following properties in the **Web Part properties dialog**:

The screenshot shows the Kentico CMS 5.0 interface. The 'Design' tab is selected in the top navigation. A 'Wishlist' web part is highlighted in the 'zoneLeft' zone of the page. The 'Web part properties (Wishlist)' dialog is open, showing the following settings:

- Default**
 - Web part control ID:
 - Visible:
 - Hide on subpages:
 - Show for document types:
 - Display to roles:
- Transformations**
 - Transformation name:
- HTML Envelope**
 - Web part container:
 - Web part container title:

Main properties

Transformation name	Transformation used in the list view mode.
----------------------------	--

5.3 Displaying and resizing images

5.3.1 Overview

If you want to use a picture multiple times on your web site, each time in different sizes, it is sufficient to upload it just once. KenticoCMS is able to resize it for you. Please consider that size of a picture can be only decreased, not increased, though. For this reason, it is important that you upload your pictures in the maximum size you want to use on your web site.

5.3.2 Displaying images

1. How to display image in transformation

To get an image in the given size, you need to insert one of the following methods into the transformation:

a) Getting image by its attachment GUID

GetImage(object attachmentGuidColumn, object maxSideSize, object width, object height, object alt)
GetImage(object attachmentGuidColumn)
GetImage(object attachmentGuidColumn, int maxSideSize)
GetImage(object attachmentGuidColumn, int width, int height)

b) Getting image by its URL

GetImageByUrl(object imageUrl, object maxSideSize, object width, object height, object alt)
GetImageByUrl(object imageUrl)
GetImageByUrl(object imageUrl, int maxSideSize)
GetImageByUrl(object imageUrl, int width, int height)

These methods use following parameters:

attachmentGuidColumn - attachment GUID
imageUrl - image url
maxSideSize - required image max side size
width - required image width
height - required image height
alt - image alternate text

All the methods generate HTML code for inserting an image according to given parameters.

Examples of displaying image in transformation by its URL

a) Using Live URL

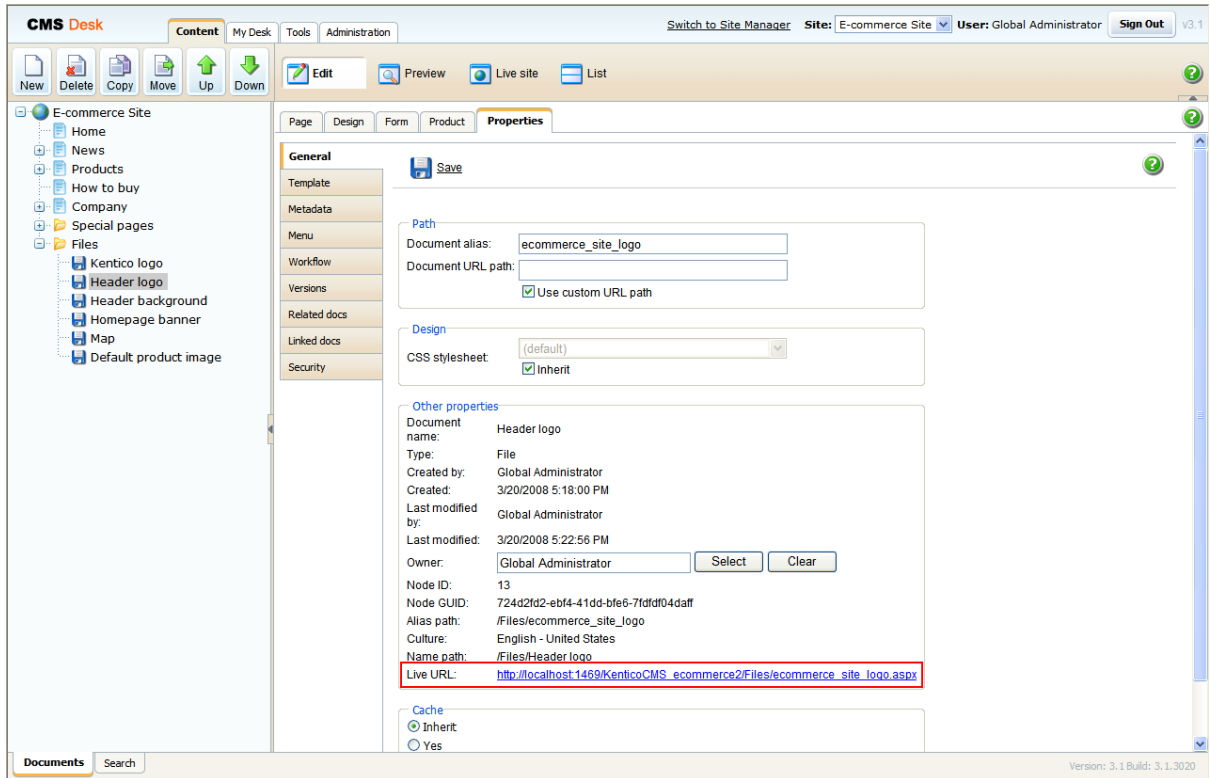

```
<%#GetImageByUrl(~/Files/ecommerce_site_logo.aspx )%>
```

b) Using the field value of the given document type that represents the image URL (e.g. SKUIImagePath):

Examples of displaying image in transformation by its attachment GUID

a) Using the field value of the given document type that represents the attachment GUID

In the following example, we have defined the new document type **Employee**. This type has two attributes: **Employee name** specified in the **EmployeeName** column and **Employee photo** specified in the **EmployeePhoto** column.

The screenshot shows the 'Form' tab selected in the top navigation bar. Below the navigation bar are 'Save' and 'Spell check' buttons. The form fields are as follows:

- employeeID:** 1
- Employee name:** David Simons
- Employee photo:** david_simons.jpg (with a red 'x' icon). Below this is an 'Upload:' field and a 'Browse...' button.
- Publish from:** 4/21/2008 09:40:25 (with a 'Now' link and a clock icon).
- Publish to:** (with a 'Now' link and a clock icon).

To display the employee photo, you need to insert the **GetImage** method with the following syntax into the transformation.

```
<%#GetImage(Eval("EmployeePhoto")) %>
```

2. How to display product image in transformation

To get a product image in the given size, you have to insert the **GetProductImage** method with the following syntax into the transformation:

GetProductImage(object imageUrl, object alt)

GetProductImage(object imageUrl, object width, object height, object alt)

GetProductImage(object imageUrl, object maxSideSize, object alt)

An example of displaying an image without resizing:

```
<%#EcommerceFunctions.GetProductImage(Eval("SKUImagePath"), Eval("SKUName")) %>
```

The **GetProductImage** method generates HTML code that will insert an image into your page. If the product image is not set, the method displays the default product image (see [Sitemanager settings](#) for more details) in the given size.



Please see the examples in the [Resizing images](#) chapter for more details.



Storing images

For the best performance while loading images, please ensure images are enabled to be stored in the file system. For more details, please refer to the [Storing images](#) chapter.

5.3.3 Storing images

To improve the performance while loading images, please check **Store Files in File System** at **CMS Site Manager -> Files**.

Checking this option enables images to be stored in the file systems. Thus, anytime an image of the given size is needed, it can be loaded directly from the file system and doesn't have to be resized again from the original picture.

To be able to store images in the file system, the modify permissions have to be set for the whole web project (See the **Disk permissions problems** chapter in **Kentico CMS Developer's Guide** for more details).

All metafiles and attachments are stored in the folder specified at **CMS Site Manager -> Settings -> Files -> Files folder**. If the **Files folder** is not set, the following happens:

- The object metafiles that are not assigned to the specific web site are stored in **<web project folder>/CMSFiles**.
- The object metafiles that are assigned to the specific web site are stored in **<web project folder>/<site name>/metafiles**.
- Attachments (they are always assigned to the specific web site) are stored in **<web project**

folder>/<site name>/files.

5.3.4 Resizing images

This chapter explains how to resize product images. However, all images in general can be resized in the following manner with usage of the methods for displaying images (**GetImage()** and **GetImageByUrl()**) with appropriate parameters.

You can set a size of the original image (width: 300px, height: 150px) in the following ways:



1. Setting Maxsize value

This sets the longer side to the value specified as **Maxsize**. The other side is calculated automatically so that the aspect ratio remains the same with the original image. In the following image, **Maxsize** is set to 250px.

The **GetProductImage** method for resizing an image to the Maxsize value of 250px:

```
EcommerceFunctions.GetProductImage(Eval("SKUImagePath"), 250, Eval("SKUName"))
```



2. Setting Height value

This sets the height of an image. The width is calculated automatically so that the aspect ratio remains the same with the original image. In the following image, **Height** is set to 100px.

```
EcommerceFunctions.GetProductImage(Eval("SKUImagePath"), 0, 100, Eval("SKUName"))
```



3. Setting Width value

This sets the width of an image. The height is calculated automatically so that the aspect ratio remains the same with the original image. In the following image, **Width** is set to 150px.

```
EcommerceFunctions.GetProductImage(Eval("SKUImagePath"), 150, 0, Eval("SKUName"))
```



4. Setting Width&Height value

The given values are set on condition they are not greater than the original size of an image. Please note that the aspect ration may not be maintained. In the following image, **Width** is set to 100px and **Height** is set to 150px.

```
EcommerceFunctions.GetProductImage(Eval("SKUImagePath"), 100, 150, Eval("SKUName"))
```



In the following image, **Width** is set to 300px and **Height** is set to 50px.

```
EcommerceFunctions.GetProductImage(Eval("SKUImagePath"), 300, 50, Eval("SKUName"))
```



If at least one value is greater than the original size of an image, the original size is set. In the following image, **Width** is set to 600px and **Height** is set to 300px.

```
EcommerceFunctions.GetProductImage(Eval("SKUImagePath"), 600, 300, Eval("SKUName"))
```



5.4 Tools

5.4.1 Overview

Kentico CMS includes a wide range of modules which can be used to build your e-commerce solution.

The included modules are:

- Bizforms
- Blogs
- Booking system
- Content staging
- Event calendar
- File import
- Forums
- GeoMapping
- Image gallery
- Messaging
- Newsletters
- Polls
- Reporting
- RSS feeds
- User contributions
- Web analytics
- Web farm synchronization

Please note that you are not limited to the pre-defined modules. You can easily create your own modules with the desired functionality. Please see the **Custom modules** chapter in **Kentico CMS Developer's Guide** for more details.

Please note that not all versions of Kentico CMS support all modules. For more information about modules which are included in the specific version of Kentico CMS please see the the feature matrix at Kentico web site (<http://kentico.com/cms-asp-net-features/Feature-Matrix.aspx>).



5.4.2 BizForms

The BizForms module enables you to create and publish simple on-line forms without writing a single line of code. For instance, you can manage communication with your customers more effectively using the **Contact us** form.

You can edit BizForms properties at **CMS Desk -> Tools -> BizForms -> <edit BizForm>**.

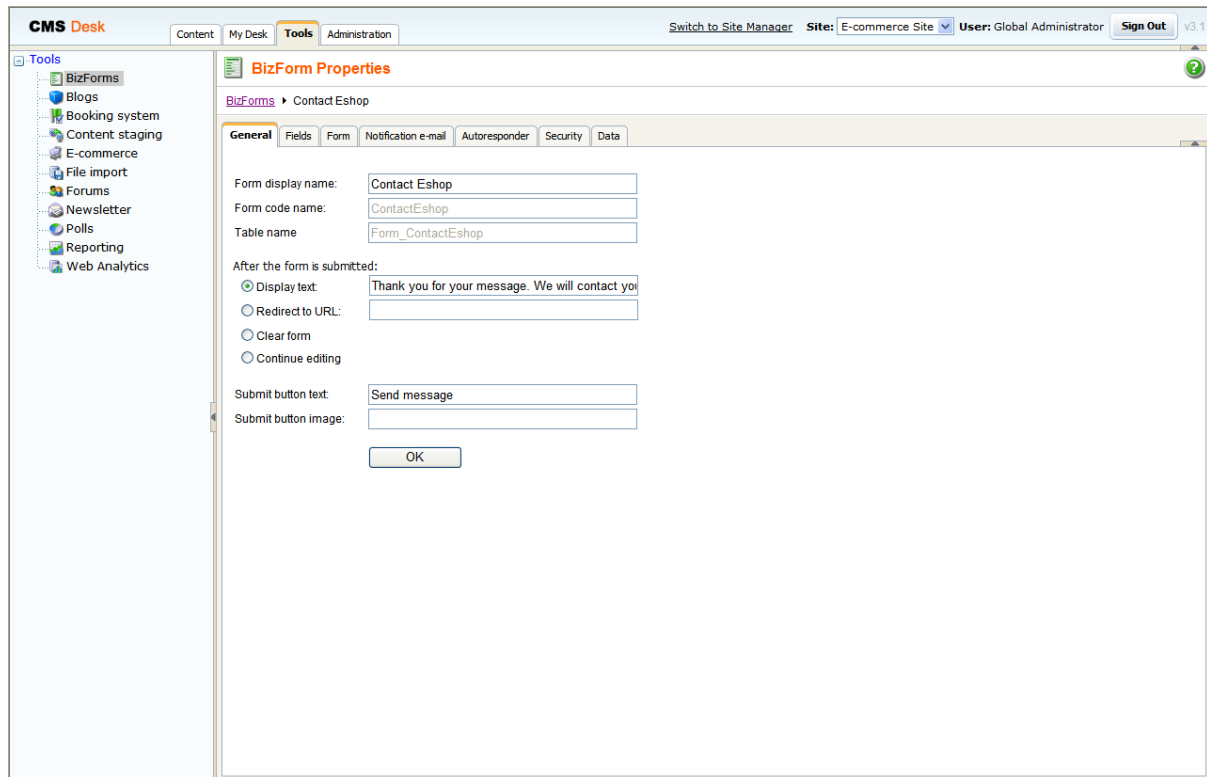

The screenshot displays the 'BizForm Properties' dialog box within the CMS Desk application. The dialog is titled 'BizForm Properties' and is currently showing the 'General' tab. The 'Form display name' is 'Contact Eshop', the 'Form code name' is 'ContactEshop', and the 'Table name' is 'Form_ContactEshop'. Under the 'After the form is submitted:' section, the 'Display text' option is selected, with the text 'Thank you for your message. We will contact you'. Other options include 'Redirect to URL:', 'Clear form', and 'Continue editing'. The 'Submit button text' is 'Send message' and the 'Submit button image' field is empty. An 'OK' button is located at the bottom of the dialog. The background shows the CMS Desk interface with a navigation tree on the left and a top menu bar.

For more details and information about BizForms please refer to the **Module BizForms** chapter in **Kentico CMS Developer's guide**.

5.4.3 Blogs

The Blogs module allows you to publish a personal or company blog. You can publish multiple blogs on the same site and there can be multiple editors for each blog.

You can edit blogs at **CMS Desk -> My Desk -> My Blogs**.

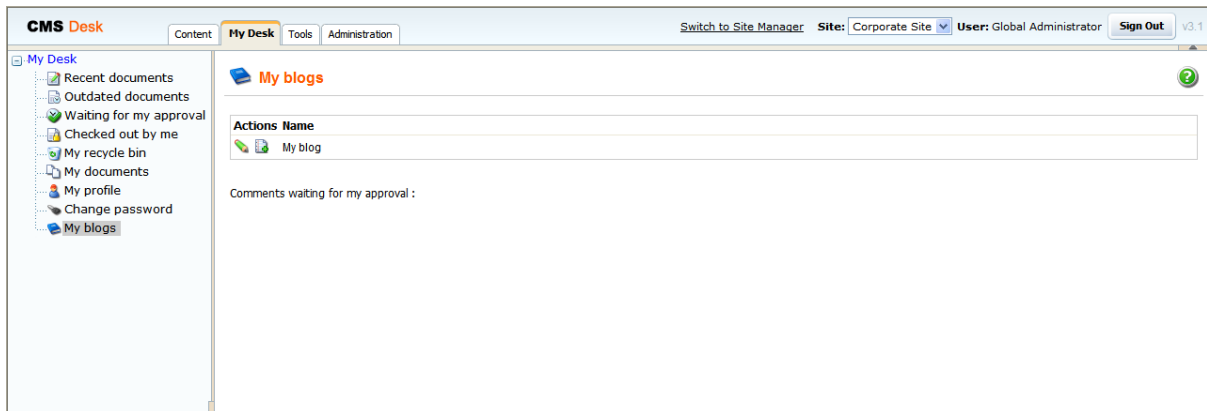

For more details and information about blogs please refer to the **Module Blogs** chapter in **Kentico CMS Developer's guide**.

5.4.4 Booking system

The booking system enables you to create an event and manage its attendees. After attendees are added, you can send e-mails to them with the important information about the event. The booking system can be used both for on-line and off-line meetings.

You can edit events and add attendees at **CMS Desk -> Tools -> Booking system -> <view event>**.

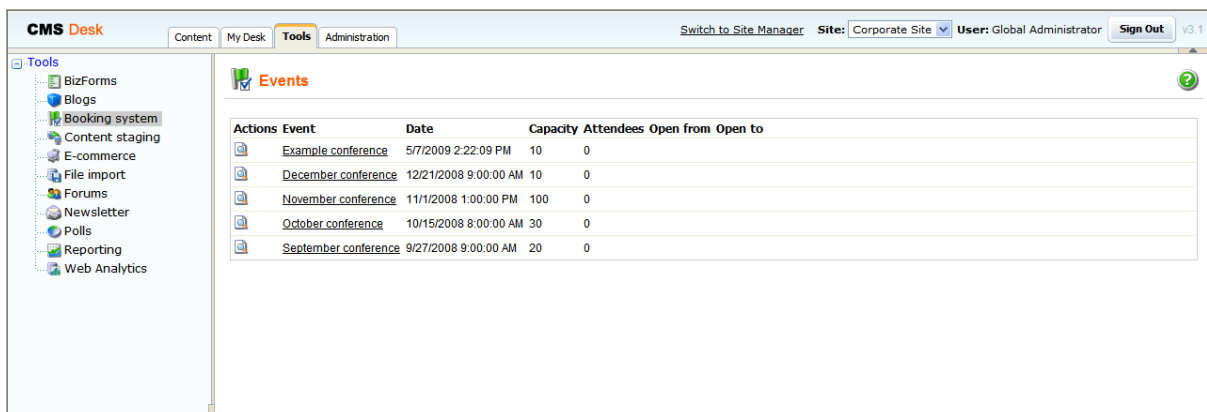

For more details and information about Booking system please refer to the **Module Booking system** chapter in **Kentico CMS Developer's guide**.

5.4.5 Content staging

The **Content staging** module allows you to store separately the content in development, staging (editing) and production (live) environment. It allows you to easily transfer document and object changes to another server or make a complete synchronization of documents and objects from one server to another.

You can manage content staging at **CMS Desk -> Tools -> Content staging**.

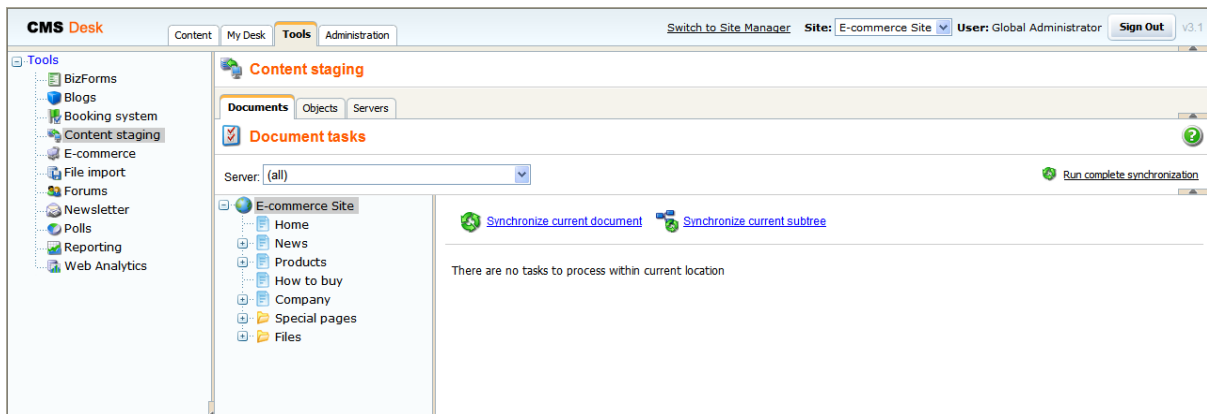

For more details and information about Content staging please refer to the **Module Content Staging** chapter in **Kentico CMS Developer's guide**.

5.4.6 Event calendar

You can use the **Event calendar** module for displaying documents ordered by date in a calendar. Various document types can be displayed in the calendar, depending on the settings.

For the **Event calendar** module implementation, use the **Events -> Event calendar** web part.

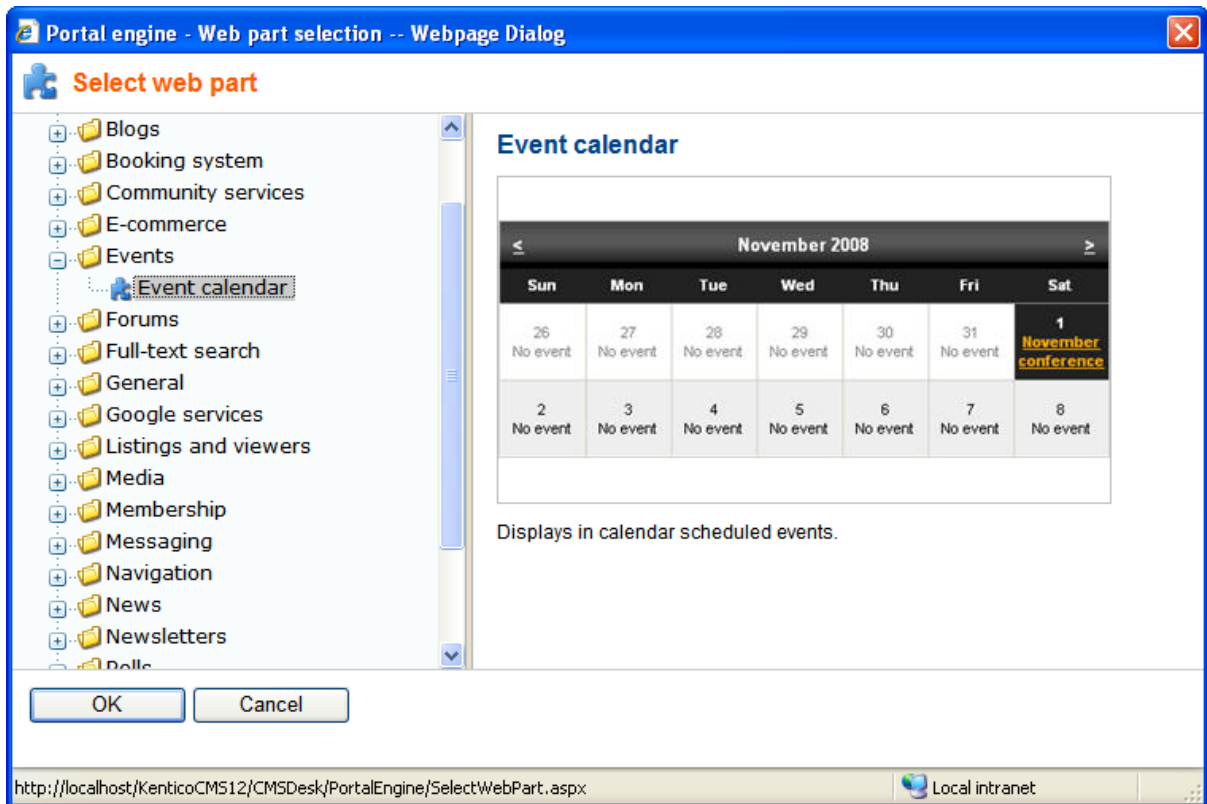

For more details and information about **Event calendar** please refer to the **Module Event calendar** chapter in **Kentico CMS Developer's guide**.

5.4.7 File import

The **File import** module allows you to import many files including their folder structure from the disk to Kentico CMS content repository, so that you do not have to upload the one-by-one using the user interface.

You can configure the path to your import directory at **CMS Desk -> Tools -> File import**.



For more details and information about **File import** please refer to the **Module File import** chapter in **Kentico CMS Developer's guide**.

5.4.8 Forums

The Forums module allows your customers to add comments and feedback to each product.

You can edit forums on your web site at **CMSDesk -> Tools -> Forums -> <edit forum group>**.

The screenshot shows the 'Forum group properties' page in CMS Desk. The left sidebar lists various tools like BizForms, Blogs, Booking system, etc. The main area is titled 'Forum group properties' and shows the 'AdHoc forum group'. Below this, there's a 'Forums' section with a 'General' tab selected. It features an 'Add forum' button and a search field with 'LIKE' selected. A table lists the following forum entries:

Actions	Forum name	Status	Moderated	Threads	Posts	Last post	Last post by
	Configurable PC	Open	No	1	1	5/26/2008 12:09:40 PM	administrator
	Canon Digital Rebel XTl	Open	No	2	5	3/5/2008 7:15:51 PM	Jane
	Nikon D40	Open	No	1	2	3/5/2008 7:06:03 PM	administrator
	iRiver T60	Open	No	1	3	3/5/2008 6:48:45 PM	Alex
	Tiger Extreme PC	Open	No	1	4	3/5/2008 6:57:59 PM	administrator
	iPod Nano	Open	No	1	3	3/5/2008 7:18:43 PM	Mike
	Asus A639	Open	No	1	2	3/5/2008 7:20:49 PM	administrator
	Motorola V3 Razr	Open	No	1	2	3/5/2008 7:24:47 PM	administrator
	Nokia 6300	Open	No	1	2	3/5/2008 7:27:13 PM	administrator
	Creative Zen Stone	Open	No	1	2	3/5/2008 7:30:01 PM	administrator
	HP IPAQ hx2795 Pocket PC	Open	No	1	2	3/5/2008 7:32:30 PM	administrator

After choosing a forum group, you can edit(✎), delete(✖) and move up(⬆) and down(⬇) individual forums.

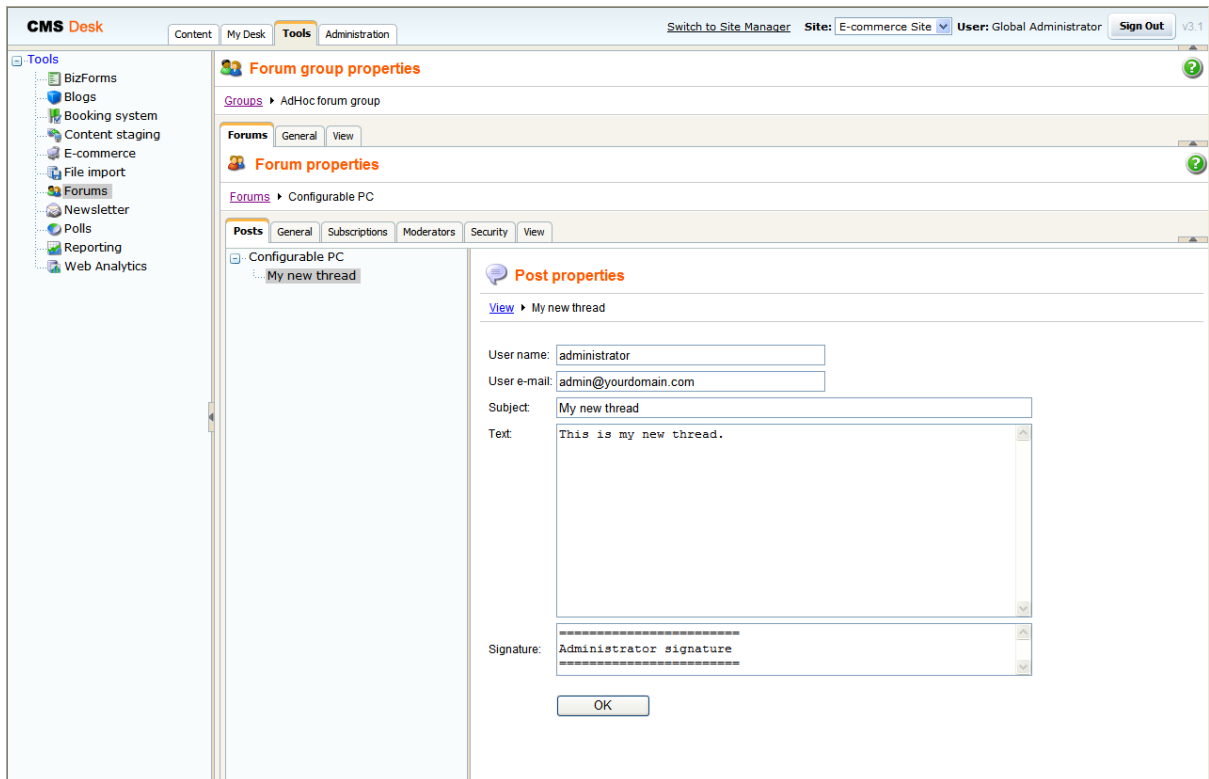

After you choose a forum to edit you can add, edit and delete threads and posts at of the given forum.

For more information please refer to the **Module Forums** chapter in **Kentico CMS Developer's guide**.

5.4.9 GeoMapping

The **GeoMapping** module uses Google Maps to display content on the map. You can use this module to display your offices, your store, your partners or real estates you offer on a map.

For the **GeoMapping** module implementation, use the **Google services -> Google Maps** web part.

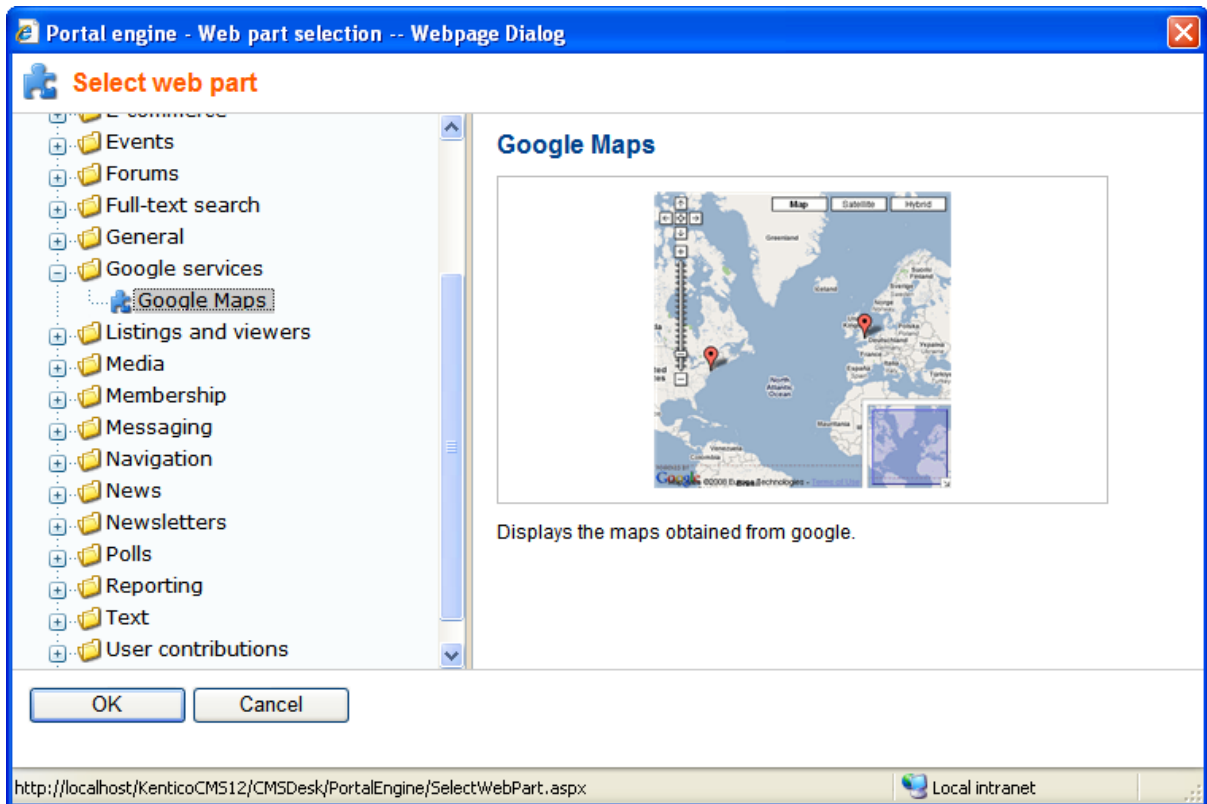

For more details and information about **GeoMapping** please refer to the **Module GeoMapping** chapter in **Kentico CMS Developer's guide**.

5.4.10 Image Gallery

Using the **Image Gallery** module, you can create easily image gallery pages. The module encompasses three page templates and three web parts suitable for creating image galleries.

For the implementations of **Image Gallery**, use the **Content slider**, **Image gallery** and **Lightbox** web parts.

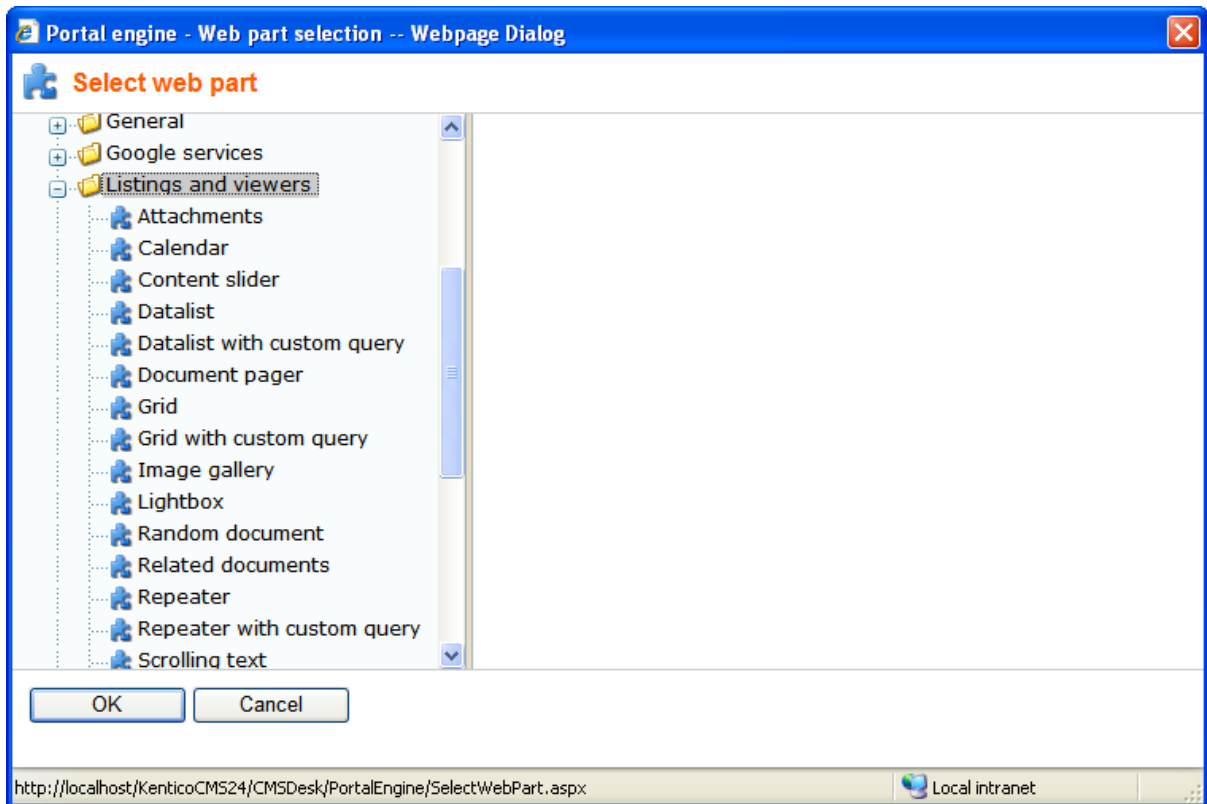

For more details and information about **Image Gallery** please refer to the **Module Image Gallery** chapter in **Kentico CMS Developer's guide**.

5.4.11 Messaging

The **Messaging** module allows you to send, receive and manage messages. Its purpose is to provide an internal way of communication with other users of the website.

For the **Messaging** module implementation, use the web parts from the **Messaging** folder in the **Web part selection** dialog.

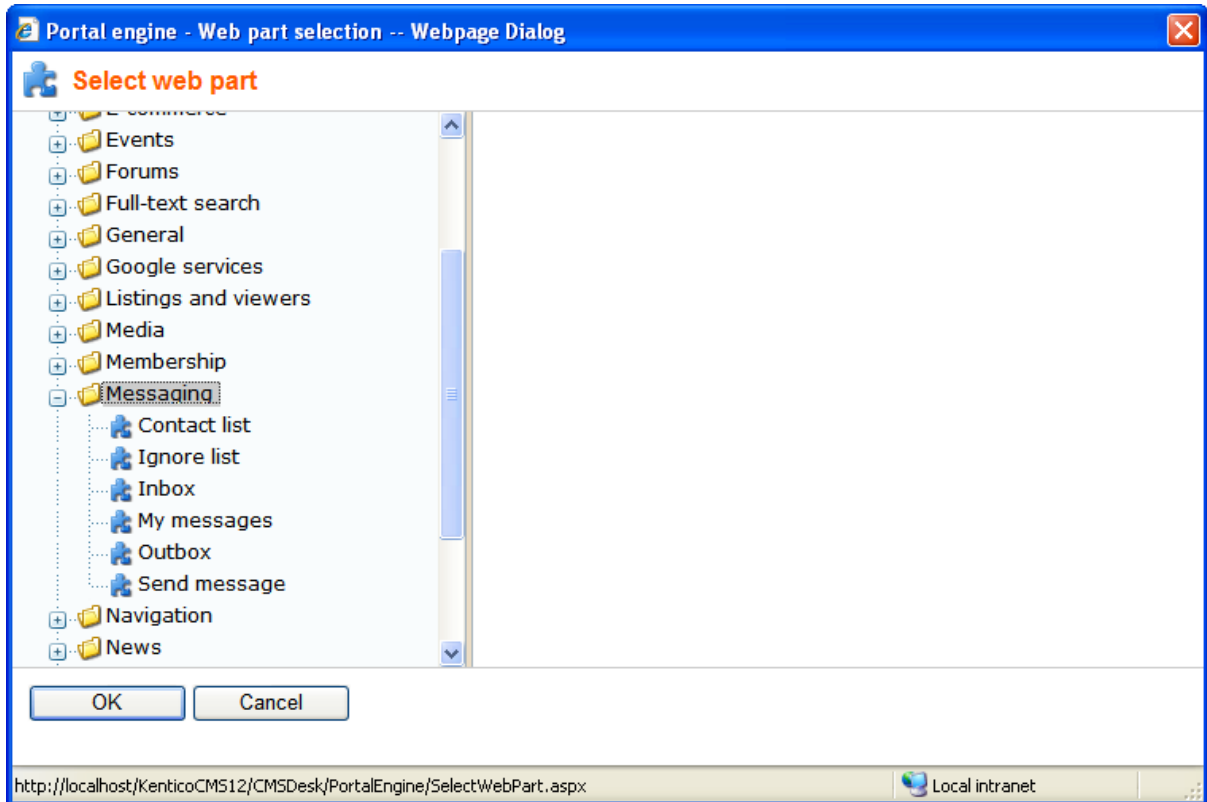

For more details and information about **Messaging** please refer to the **Module Messaging** chapter in **Kentico CMS Developer's guide**.

5.4.12 Newsletters

The Newsletter module allows you to author and mail out e-mail newsletters. Through newsletters, you can inform your customers about new products, current offers and discounts and much more. The newsletter can be static or dynamic.

You can edit newsletters at **CMS Desk -> Tools -> Newsletters**.

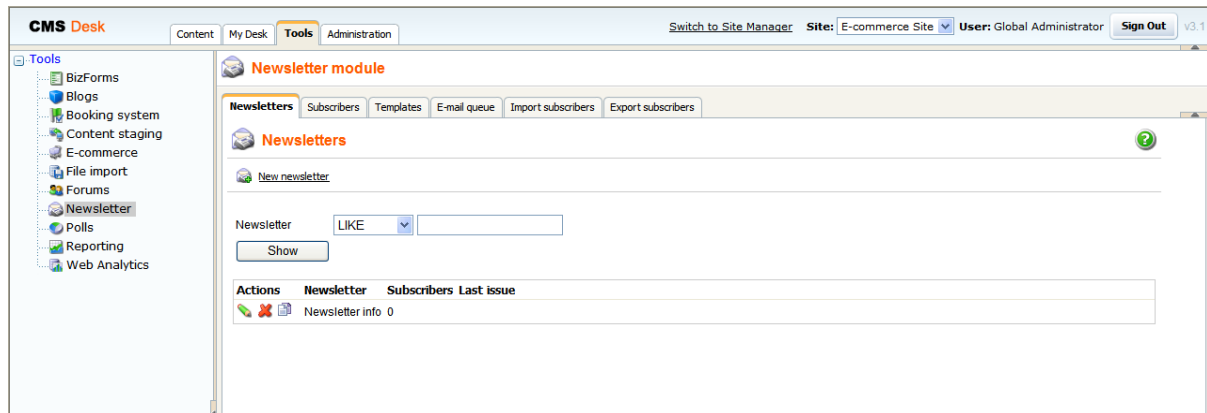

For more details and information about newsletters please refer to the **Module Newsletters** chapter in **Kentico CMS Developer's guide**.







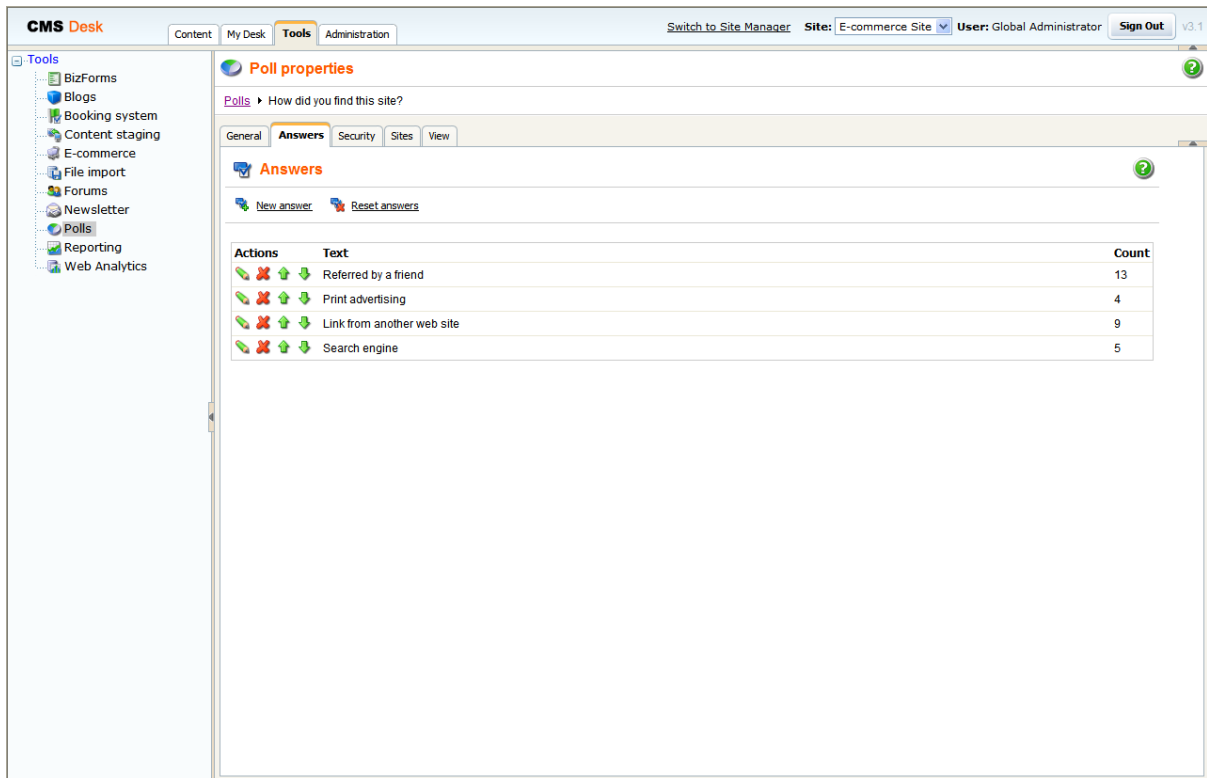









5.4.13 Polls

The Polls module enables you to create and publish polls with single or multiple answer so that you are able to get vital information about how are your customers and what they want.

You can edit polls at **CMS Desk -> Polls -> <edit poll>**.



The screenshot shows the 'Poll properties' page in the Kentico CMS Desk. The poll title is 'How did you find this site?'. The 'Answers' tab is selected, showing a table of responses. The table has three columns: 'Actions', 'Text', and 'Count'.

Actions	Text	Count
   	Referred by a friend	13
   	Print advertising	4
   	Link from another web site	9
   	Search engine	5

After you choose a poll to edit, you can set the poll question at the **General** tab and the poll answers at the **Answers** tab.

For more details and information about polls please refer to the **Module Polls** chapter in **Kentico CMS Developer's guide**.

5.4.14 Reporting

The Reporting module enables you to create internal reports to watch activity in the Kentico CMS system and on the web site. Kentico CMS comes with several pre-defined e-commerce reports that show statistics related to your online business.

The following pre-defined e-commerce reports are available:

- Inventory
- Number of orders per day
- Number of orders per month
- Number of orders per year
- Sales per day
- Sales per month
- Sales per year
- Top 100 customers by volume sales

You can edit reports at **CMS Desk -> Tools -> Reporting -> <edit Report category>**.

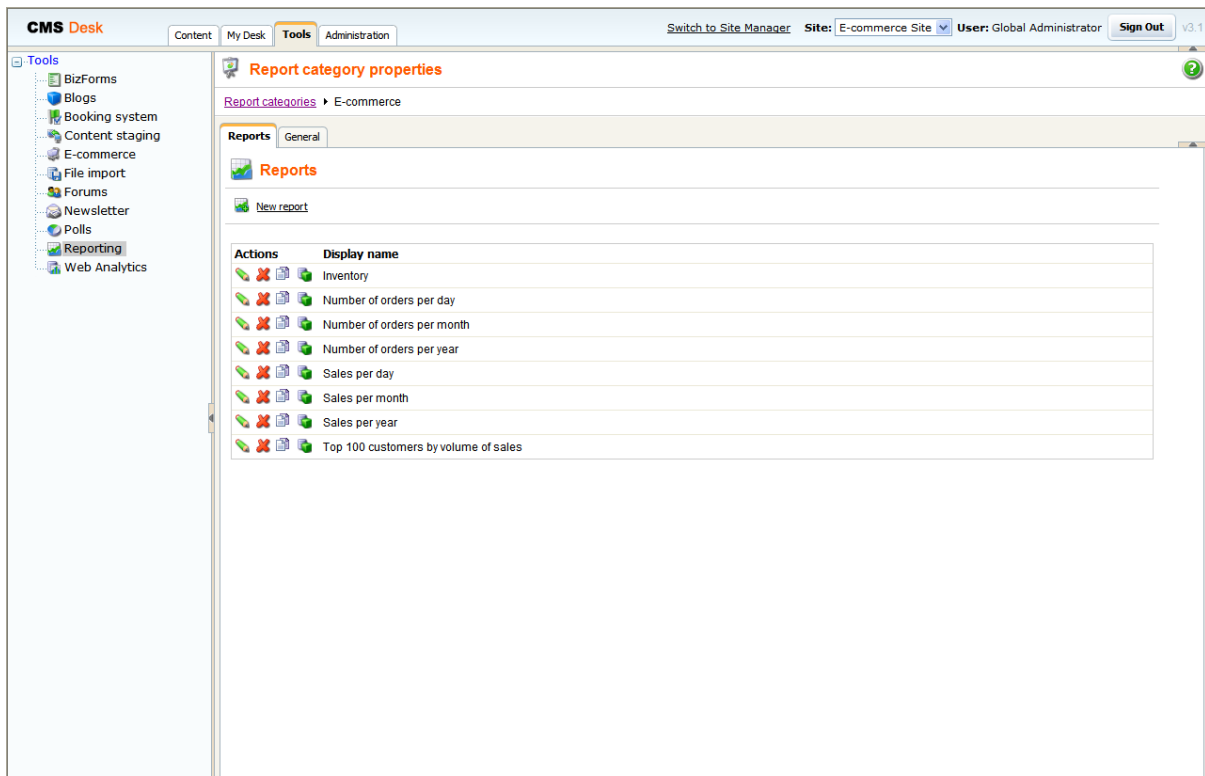

After choosing a report category, you can edit() or delete() individual reports.

For more details and information about how to set report properties please refer to the **Module Reporting** chapter in **Kentico CMS Developer's guide**.

5.4.15 RSS Feeds

Kentico CMS allows you to publish content using a RSS 2.0 feed. The default installation contains a simple `CMSPages\NewsRss.aspx` page that shows how to build your own RSS feed. It works with news items, but you can modify the code so that it displays a different type of documents.

For more details and information about **RSS Feeds** and about how to create RSS Feed for a different type of documents please refer to the **Module RSS Feeds** chapter in **Kentico CMS Developer's guide**.

5.4.16 User Contributions

The **User Contributions** module allows you to create content editing interface for site members. Using this interface, the web site visitors are able to create, edit and delete content, even if they are not editors and cannot access Kentico CMS Desk.

For the **User Contributions** module implementations, use the **Contribution list** and **Edit contribution** web part.

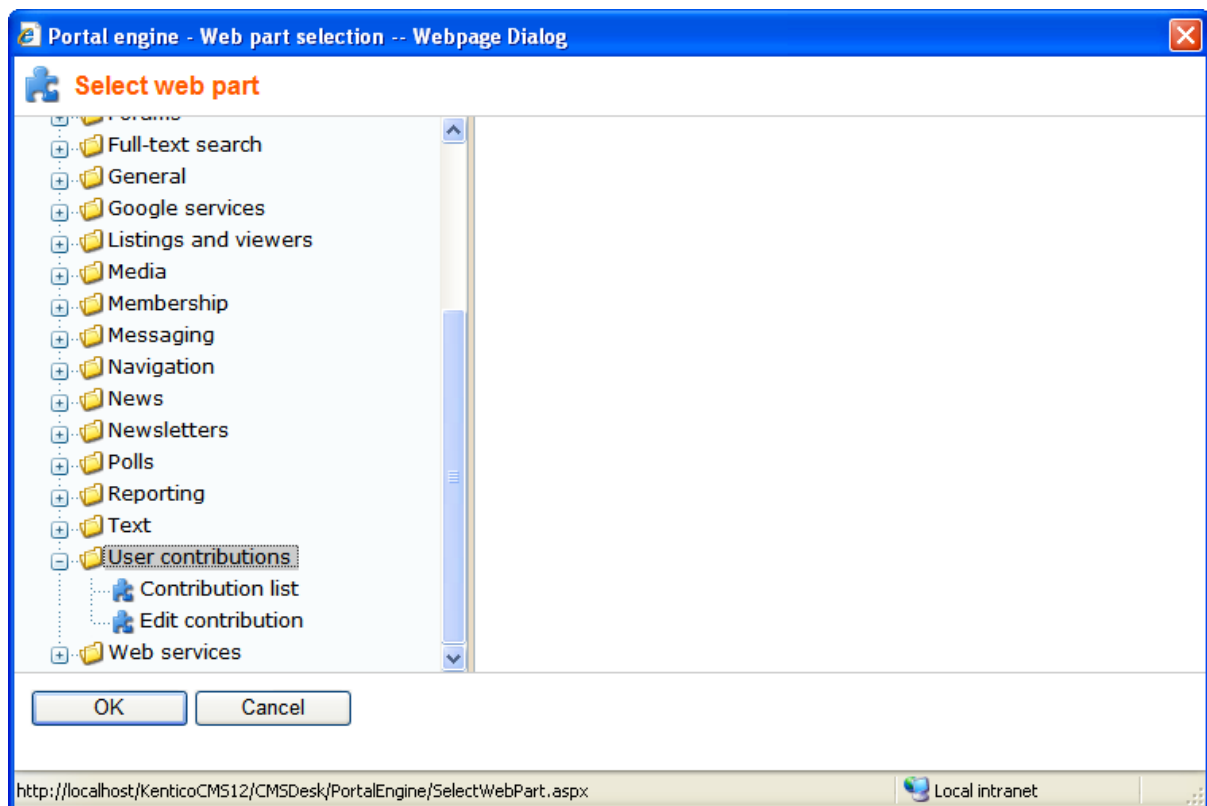

For more details and information about **User Contributions** please refer to the **Module User Contributions (Wiki)** chapter in **Kentico CMS Developer's guide**.

5.4.17 Web Analytics

The Web Analytics module enables you to track and analyze web site visits, page views, file downloads and other metrics of the web site.

You can modify view the Web Analytics reports at **CMS Desk -> Tools -> Web Analytics**.

The screenshot displays the CMS Desk interface for the Web Analytics module. The top navigation bar includes 'Content', 'My Desk', 'Tools', and 'Administration'. The 'Tools' menu is expanded, showing various reports like 'Browser types', 'Campaigns', 'Conversions', etc. The main content area shows a 'Browser types' report for the year 2008, with a 'Show' button. Below this, a calendar view highlights May 2008. A pie chart titled 'Browser types' (from 1/1/2008 12:00:00 AM to 1/1/2009 12:00:00 AM) is displayed, showing a single slice for 'Others'.

For more details and information about **Web Analytics** please refer to the **Module Web Analytics** chapter in **Kentico CMS Developer's guide**.

5.4.18 Web Farm synchronization

Kentico CMS offers native web farm support. The web farm support provides the synchronization of the changes made to the site settings on one of the servers to all the other servers and provides synchronization of the files uploaded to the site to all other servers.

You can manage web farm servers at **CMS Site Manager -> Administration -> Web farm**.

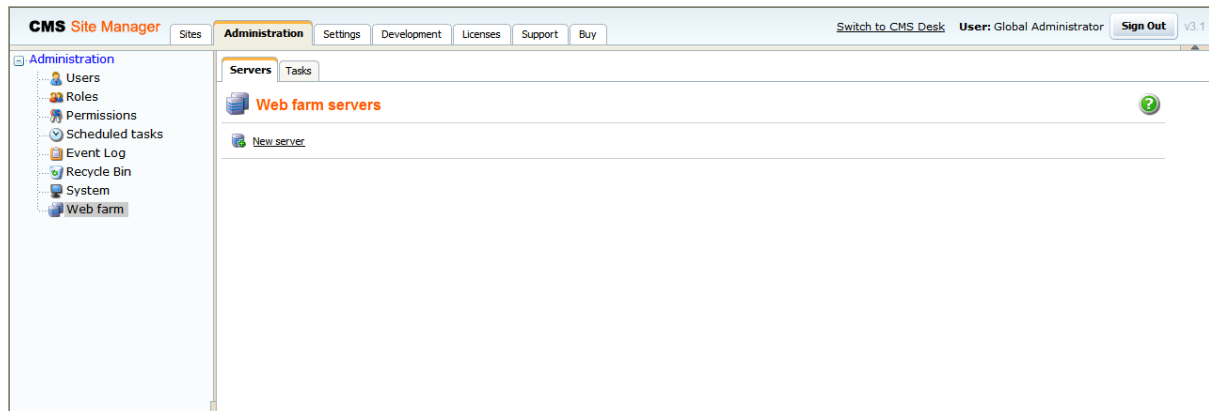

For more details and information about **Web Farm synchronization** please refer to the **Module Web Farm synchronization** chapter in **Kentico CMS Developer's guide**.

5.5 Adding items to the shopping cart

The items can be added to the shopping cart by calling the page with the **Shopping cart** web part with following URL parameters:

- **productId** - the ID of the product stored in the NodeSKUID database field (in the CMS_Tree table) or SKUID (in the COM_SKU table)
- **quantity** - the number of product units to be added to the shopping cart
- **options** - the string of the selected product option IDs separated by commas

It means your link will typically look like this:

```
<a href="~/shoppingcart.aspx?productId=10&quantity=1&options=12,24">Add to cart</a>
```

This link has been generated by the following **ShoppingCartItemSelector** control. All you have to do is adding the control to transformation and setting its properties accordingly.

1. Product detail

```
<%@ Register Src="~/CMSModules/Ecommerce/Controls/ProductOptions/
ShoppingCartItemSelector.ascx" TagName="CartItemSelector" TagPrefix="ucl" %>

<ucl:CartItemSelector id="cartItemSelector" runat="server" SKUID='<%#
ValidationHelper.GetInteger(Eval("SKUID"), 0) %>' SKUEnabled='<%#
ValidationHelper.GetBoolean(Eval("SKUEnabled"), false) %>'
AddToCartImageButton="AddToCart.gif" ShowUnitsTextBox="true"
ShowProductOptions="true" AddToWishlistImageButton="AddToWishlist.gif" />
```

The control has the **ShowUnitsTextBox** and **ShowProductOptions** properties set to **true**. Therefore, the product options and units text box are visible on the web site. Please note that **AddToWishlistImageButton** properties is set as well. Thus, the **Add to wishlist** button is displayed as well.

The screenshot displays a web application interface for an Acer configurator. The main content area shows the product details, including a list of parameters and a price section. The price is \$ 899.00. Below the price, there is a section for product options, which is highlighted with a red box. This section contains three dropdown menus for product options: Notebooks - DDR2 modules (512MB DDR2 (+ \$ 35.00)), Notebooks - HDD (Samsung 80GB SATA (+ \$ 80.00)), and Notebooks - Intel CPU (Intel Core 2 Duo 1500Mhz (+ \$ 260.00)). At the bottom of the configurator section, there is an 'Add to wishlist' button, a 'Units text box' with the value '1', and an 'Add to cart' button. The right sidebar features 'Featured products' (iPod Nano, Nikon D40, iPod Shuffle, iPod Classic), 'Latest news', and a 'Newsletter subscription' form.

2. Product list

```
<%@ Register Src="~/CMSModules/Ecommerce/Controls/ProductOptions/
ShoppingCartItemSelector.ascx" TagName="CartItemSelector" TagPrefix="ucl" %>

<ucl:CartItemSelector id="cartItemSelector" runat="server" SKUID='<%#
ValidationHelper.GetInteger(Eval("SKUID"), 0) %>' SKUEnabled='<%#
ValidationHelper.GetBoolean(Eval("SKUEnabled"), false) %>'
AddToCartImageButton="AddToCart.gif" ShowUnitsTextBox="false"
ShowProductOptions="false" />
```

This control has **ShowUnitsTextBox** and **ShowProductOption** properties set to **false**. Therefore, the product options and units text box are not visible on the web site.

Sign in to [CMS Desk](#). Sign in to [CMS Site Manager](#). The default account is administrator with blank password.

E-commerce starter site

Electronics for you

Shopping cart | My account | My wishlist

Your shopping cart is empty







Home News Products How to buy Company

Search



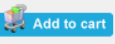

Products

- >> Cameras
- >> Cell phones
- >> MP3 Players
- >> Notebooks
 - >> 13"
 - >> 14"
 - >> 15"
 - >> 17"
- >> PDAs
- >> PCs

Products / Notebooks

 Configure your notebook	 Configure your notebook	
Acer configurator \$ 899.00 	Acer configurator \$ 899.00 	Acer Aspire 3105WLMi \$ 941.00 

ShoppingCartItemSelector.ascx

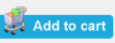
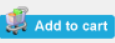
		 Configure your notebook
Asus F3U AP059C \$ 999.00 	Lenovo T61 \$ 999.00 	Lenovo configurator \$ 999.00 

Sign In

iPod Nano
\$ 199.00

Nikon D40
\$ 490.00

iPod Shuffle
\$ 79.00

Canon Digital Rebel
XTI
\$ 597.00

Latest news

2/13/2008

[Dear customers, our shop now supports payments through PayPal. You can use this feature from this day.](#)

2/13/2008

Poll

How did you find this site?

Referred by a friend

Print advertising

Link from another web site

Search engine

Complete list of shopping cart item selector properties:

SKUID	Product ID
SKUEnabled	Indicates whether the current product is enabled. If set to true , the button/link for adding product to the shopping cart is rendered, otherwise it is not rendered.
AddToCartImageButton	File name of the image which is used as a source for image button to add product to the shopping cart, default image folder is '~/App_Themes/<stylesheet name>/Images/ShoppingCart/'.
AddToCartLinkText	String (simple text or localizable string) of the link to add product to the shopping cart.
ShowUnitsTextBox	Indicates if text box for entering number of units to add to the shopping cart should be displayed. If it is hidden, number of units is equal to DefaultQuantity .
ShowProductOptions	Indicates if product options of the current product should be displayed. If ShowProductOption is set to false and a customer clicks Add to shopping cart for a products with specified product options, she is redirected to product detail where she is required to choose product option before the product can be added to the shopping cart.
DefaultQuantity	Default quantity when adding product to the shopping cart, it is set to 1 by default.
ShowTotalPrice	If true, total price will be shown in the bottom section of the product options list.
ShowPriceIncludingTax	If true, the total price enabled by the ShowTotalPrice property and product option prices will be displayed with tax added. If false, tax will not be included in the total price.

Displaying total product price

If you enable the **ShowTotalPrice** property of the shopping cart item selector, a total price of the product including prices of product options will be displayed at the bottom section of the product options list, as you can see in the screenshot below. The price can either be displayed with or without tax, based on the value of the **ShowPriceIncludingTax** property of the control. Displayed prices of the product options are affected by the value of this property too.

Our price: \$899.00
Without tax: \$899.00

Notebooks - Intel CPU
Intel Core 2 Duo 1500Mhz (+ \$260.00)

Notebooks - HDD
Samsung 80GB SATA (+ \$80.00)

Notebooks - DDR2 modules
512MB DDR2 (+ \$35.00)

Our world model was built specifically to investigate five major trends of global concern – accelerating industrialization, rapid population growth, widespread malnutrition, depletion of nonrenewable resources, and a deteriorating environment.

Total price (without tax): \$1274.00



Shopping cart URL

If you use **ShoppingCartItemSelector**, the shopping cart URL is taken from the **Site Manager -> Settings -> E-commerce -> Shopping cart URL** value.

5.6 Adding items to the wish list

The items can be added to the wish list by calling the page with the **Wishlist** web part with following URL parameter:

- **productId** - the ID of the product stored in the NodeSKUID database field (in the CMS_Tree table) or SKUID (in the COM_SKU table)

It means your link will typically look like this:

```
<a href="~/wishlist.aspx?productId=10">Add to wish list</a>
```

In the transformations, you can use the following method to display the link to the wish list:

```
<%# EcommerceFunctions.GetAddToWishListLink(Eval("NodeSKUID")) %>
```

You can use the **ShoppingCartItemSelector** control to display the **Add to wishlist** button as well. All you have to do is to set one of the following properties.

AddToWishlistImageButton	File name of the image which is used as a source for image button to add product to the wish list, default image folder is '~/App_Themes/<stylesheet name>/Images/ShoppingCart/'.
AddToWishlistLinkText	String (simplet text or localizable string) of the link to add product to the wish list.



Wish list URL

If you use **ShoppingCartItemSelector** or functions like `GetAddToWishListLink`, the wish list URL is taken from the **Site Manager -> Settings -> E-commerce -> Wish list URL** value.

5.7 Displaying product price

Displaying product price on the web site

The price is stored in the COM_SKU.SKUPrice field. The following method allows you to display the price **in your transformation** in the currently selected currency, with appropriate discount level and in the appropriate format specified at **CMS Desk -> Tools -> E-commerce -> Configuration -> Currencies -> <edit currency> -> Currency formatting string**:

```
<%# EcommerceFunctions.GetFormattedPrice(Eval("SKUPrice"), Eval("SKUDepartmentID")) %>
```

If you want to display prices with applied discount level and taxes as well, use the following function instead.

```
<%# EcommerceFunctions.GetFormattedPrice(Eval("SKUPrice"), Eval("SKUDepartmentID"), Eval("SKUID")) %>
```

Please note: computation of all product taxes is time-consuming. Therefore, the result is stored in the cache as specified at **CMS Site Manager -> Settings -> Web Site -> Cache content (minutes)**.

If you don't want to display prices with the applied discount level and taxes, use the following function instead.

```
<%# EcommerceFunctions.GetFormattedPrice(Eval("SKUPrice")) %>
```

All product prices are displayed in currency chosen according to the following priorities:

1. **the currency of the shopping cart**
2. **the preferred currency of a customer**
3. **the default currency**

Therefore, if the currency of the shopping cart is not set yet (the shopping cart hasn't been created so far), all product prices are displayed in the preferred currency of the given customer. If the customer doesn't specify the preferred currency, all product prices are displayed in the default currency.

5.8 Getting product URL

In some cases, you may need to get the URL of the document to which some product is assigned. Knowing product URL can be useful when you work with specific web parts such as the **Product datalist** which is using the e-commerce product (SKU) properties to display products instead of the standard CMS documents.

For this, you need to insert the **GetProductUrl** method with the following syntax into your transformation:

```
<%# EcommerceFunctions.GetProductUrl(Eval("SKUID")) %>
```

As a result, you will get the product URL in the **/CMSPages/GetProduct.aspx?productId=125** format.

Alternatively, you can provide the method with values of the **SKUGUID** and **SKUName** columns:

```
<%# EcommerceFunctions.GetProductUrl(Eval("SKUGUID"), Eval("SKUName")) %>
```

This syntax returns the URL in the **~/getproduct/<skuguid>/<safe_skuname>.<extension>** format.

5.9 Searching

Kentico CMS comes with the built-in search engine that enables you to search for the given expression in the content of your web site.

You can modify the search engine functionality at **CMS Desk -> Content -> E-commerce -> Special Pages -> Search -> cmscompletesearchdialog**.

The screenshot displays the Kentico CMS Desk interface for an E-commerce site. The left sidebar shows a tree view of the site structure, including 'Special pages' and 'Search'. The main content area shows the 'Design' view of a search page template. The search dialog configuration is visible, showing the 'zoneContent' section with the 'cmscompletesearchdialog' control selected. The search mode is set to 'Any Word'. The interface also shows a navigation menu with 'Products', 'Company', 'News', 'Home', and 'How to buy' options. A shopping cart notification is visible in the top right corner.

Additionally, you can specify what documents and types of documents exclude from the search at **CMS Site Manager -> Settings -> Web Site**.

The screenshot shows the 'Settings' page for the 'Web Site' in Kentico CMS. The left sidebar contains a tree view with categories like 'Content Management', 'Files', 'Security', 'URLs', 'Output filter', 'System', 'E-mails', 'Forums', 'Blogs', 'Web analytics', 'Booking system', 'Content staging', 'Messaging', 'E-commerce', 'Payment Gateway - Authorize.NET', and 'Payment Gateway - PayPal'. The main content area lists various settings, each with a 'Save' button. Two settings are highlighted with a red box: 'Exclude Document Types From Search' and 'Exclude Documents From Search'. Both have empty text input fields and a 'Save' button.

Exclude Document Types From Search	Specifies document types that should NOT be searched. You can specify several document types separated with semicolon (;).
Exclude Documents From Search	Specifies site sections that should be excluded from search. You can specify several site sections or particular documents, separated with semicolon (;). You can use wildcard character %.

For the E-commerce site, by default, the **cms.file** is set as a document type that is excluded from search. Therefore, the **File** document type (cms.file) won't be searched.

For more information about Kentico CMS search engine, please refer to the **Search engine** chapter in **Kentico CMS Developer's guide**.

Part

VI

Configuration settings

6 Configuration settings

6.1 Configuration overview

When you start using the **E-commerce module** it's recommended that you configure it in the following order:

1. Enable the **E-commerce module** at **Site Manager -> Settings** if it's not enabled yet.
More details: [Enabling the e-commerce module](#)
2. Configure **access rights** to the **E-commerce module** interface.
More details: [Security configuration](#)
3. Set up **countries and states**.
More details: [Countries and states](#)
4. Configure **store settings**.
More details: [Store settings](#)
5. Set up **departments** and assign **store administrators** to their **departments**.
More details: [Departments](#)
6. Configure **currencies**. If you plan to use multiple currencies, specify the **exchange rates**.
More details: [Currencies](#), [Exchange rates](#)
7. Set up **shipping options**.
More details: [Shipping options](#)
8. Set up **payment methods**.
More details: [Payment methods](#)
9. Configure **tax classes**.
More details: [Tax classes](#)
10. Set up order processing **workflow**.
More details: [Order status](#)
11. Configure **public and internal product status**.
More details: [Public status](#), [Internal status](#)
12. Modify the **invoice/receipt** design.
More details: [Invoice](#)
13. Create documents with product details at **CMS Desk -> Content** and mark the documents as **products**. Enter the product details.
More details: [Products](#)
14. Make a testing order for each **payment option**.

Possible configurations

The **E-commerce module** allows you to manage products in two basic modes:

- **standard mode** - you manage the products in **Kentico CMS**. Each product is represented by a combination of document that contains product information displayed to the visitor and a product record that contains standard product information, such as product price, sizes, taxes, etc.
- **custom product provider** - you manage the products in an external system and publish them inside Kentico CMS-based web site. You can learn more on custom providers in chapter [Developing custom providers](#).

6.2 Orders

The Orders can be managed at **Kentico CMS Desk -> Tools -> E-commerce -> Orders** of the e-commerce module.

General properties

- **Order ID** - unique identifier of the order
- **Date** - date and time when the order was placed
- **Invoice number** - the assigned invoice number (it can be changed on **Invoice** tab)
- **Status** - order processing status
- **Customer** - customer who made this order
- **Company address** - address of the company which made the order
- **Order note** - notes added by customer or by store managers

Shipping

- **Shipping option** - chosen shipping option
- **Shipping address** - chosen shipping address
- **Tracking number** - tracking number of the order

Billing

- **Payment method** - chosen payment method
- **Currency** - currency used in the invoice
- **Billing address** - chosen billing address
- **Payment result** - payment results as described in the [Payment results](#) chapter

Items

Here you can modify the order during its processing. Please note that to be able to additionally modify order item name and order item price **CMSUseCurrentSKUData** and **CMSEnableOrderItemEditing** keys in the web.config files have to be set accordingly. Please refer to the [Web.config settings](#) chapter for more information.

Invoice

Here you can re-generate or print the invoice and change the invoice number manually.

History

Here you can see the history of order processing.

6.3 Customers

You can manage customers at **Kentico CMS Desk -> Tools -> E-commerce -> Customers**. The customer profile can be created either manually in this administration interface or it can be created automatically when the customer registers during the purchase process.

You can create new customers here. While creating a new customer, you can choose to provide her with **User name** and **Password** and straight away and create user account for her.

General customer properties

- **First name** - customer's first name
- **Last name** - customer's last name
- **Company** - company name (optional)
- **Organization ID** - registration ID of the customer's company
- **Tax registration ID** - tax registration ID of the customer's company
- **E-mail** - customer's e-mail address
- **Phone** - customer's phone number
- **Fax** - customer's fax number
- **Preferred currency** - the currency in which the prices are displayed when the customer signs in
- **Preferred payment method** - customer's preferred payment option (automatically set based on her last purchase)
- **Preferred shipping option** - customer's preferred shipping option (automatically set based on her last purchase)
- **Country/state** - customer's main country and state
- **Enabled** - if you uncheck the box, the customer profile will not be listed in the customer list, while still being stored in the database for your records and to keep customer's purchase history.
- **Discount level** - discount level applied to the customer's orders

Addresses

Each customer can have several addresses for billing and shipping stored in her profile. Every address has the following properties:

- **Personal or company name** - name line in the address
- **Address lines** - address line 1 and address line 2
- **City** - city
- **ZIP code** - zip/postal code
- **Country** - country
- **Phone number** - phone number
- **Enabled** - indicates if the address should be offered to the client. If you set it to disabled, it will no longer be displayed, but it will be kept in the database for your records and to keep customer's purchase history.
- **Use as shipping address** - indicates if the address should be offered to customer as a shipping address
- **Use as billing address** - indicates if the address should be offered to customer as a billing address
- **Use as company address** - indicates if the address should be offered to customer as a company

address

Orders

- the list of orders made by this customer

Credit

The customer credit history.

The customer credit is stored in the default currency. If a payment is made in a currency different from default, the payment amount is converted to the default currency and the customer credit is decreased by this amount - a new credit event is created.

For information about enabling payments with the customer credit please refer to the [Customer credit](#) chapter.

The displayed total value of the customer credit is sum of all credit events.

Newsletters

Here you can select newsletters to which a customer is subscribed.

For more information about newsletters please refer to the **Newsletter module overview** chapter in **Kentico CMS Developer's Guide**.

Login

Here you can manage user's account that she uses to sign in to your e-commerce site (if she is a registered user, not only an anonymous user)

A. Customer-order relation if an order is made by an anonymous customer.

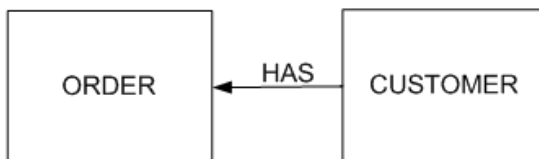

B. Customer-order-user relation if an order is made by a registered user.

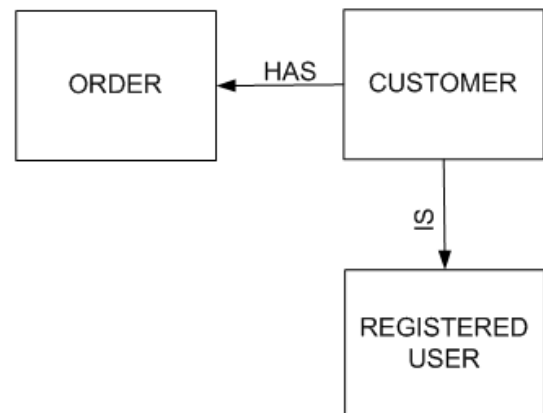

You can create and edit users at **CMS Desk -> Administration -> Users**.

The following diagram shows the checkout process for both an anonymous and authenticated user in greater detail.

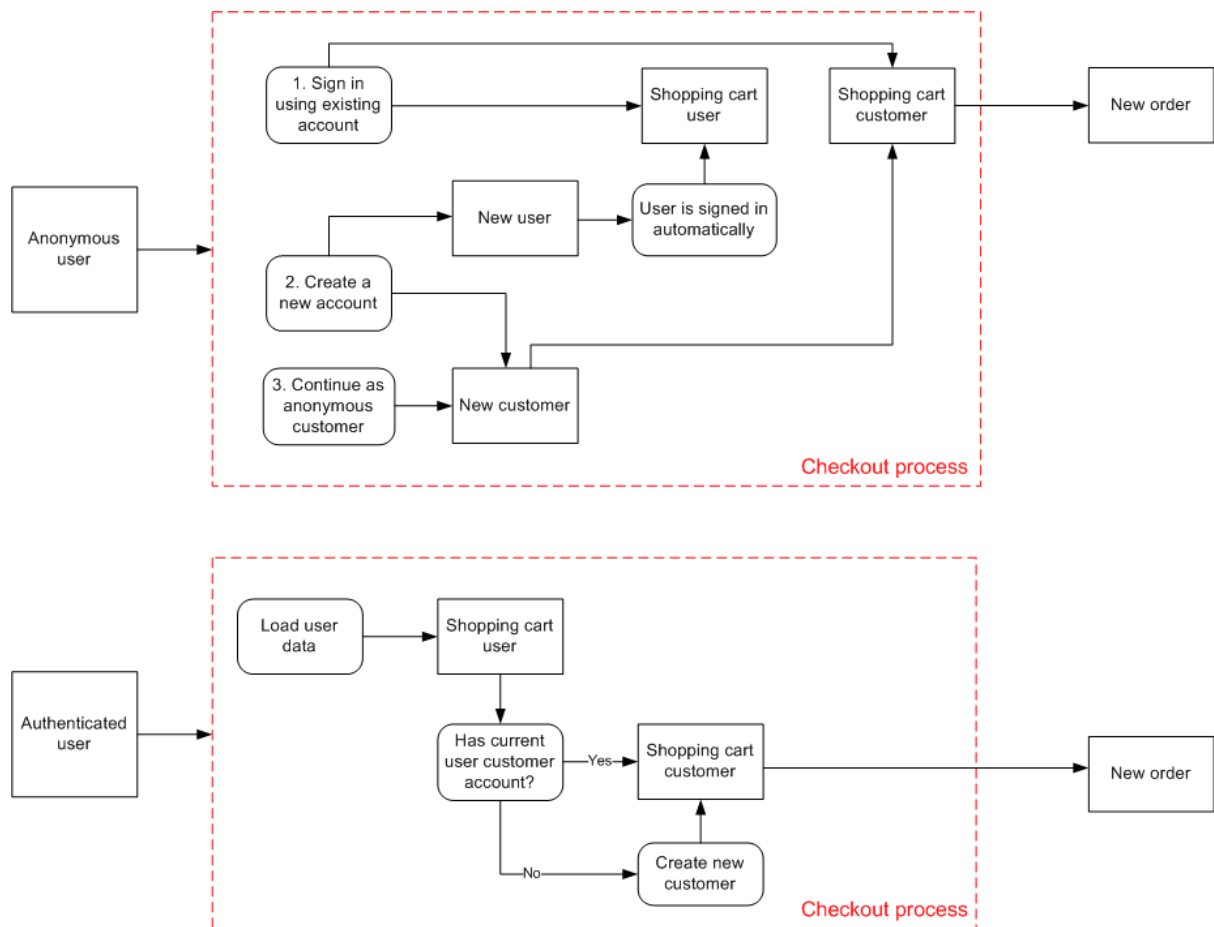

6.4 Products

Kentico CMS allows you to integrate the e-commerce data with documents. You can mark any document as a product and define its product properties.

There are two ways how you can enter the products:

1. Go to **CMS Desk -> Content -> Product**, check the **Mark document as product** box and choose **Create a new product**.
2. Go to **CMS Desk -> Tools -> E-commerce -> Products** and enter all your product details. Then go to **CMS Desk -> Content -> Product**, check the **Mark document as product** and select an existing product.

General tab

Every product has the following properties:

- **Product name** - product name displayed on the web site and in the shopping cart
- **Product number** - product number (serial number or SKU number) for your records
- **Description** - product description used for special product listings
- **Price** - product price in the main currency
- **Enabled** - indicates if product can be added to the shopping cart
- **Department** - the department that is responsible for this product
- **Manufacturer** - the manufacturer of the product
- **Supplier** - the supplier of the product
- **Public status** - status of the product displayed to site visitors - e.g. Available immediately
- **Internal status** - status of the product displayed only to the site owners - e.g. Products going off-sale. Invisible to the site visitors.
- **Availability (days)** - number of days required for processing the order (e.g. the order may require 1 day so that you get the product from the distributor)
- **Product image URL** - URL of the product image
- **Package weight** - weight in your chosen unit
- **Package height** - height in your chosen unit
- **Package width** - width in your chosen unit
- **Package depth** - depth in your chosen unit
- **Available items** - number of items available in stock
- **Sell only if items are available** - indicates if customers can purchase only quantity that is in stock (checked box)

Custom fields tab

Here you can see list of the custom fields available for all products. You can specify the custom fields at **CMS Site Manager -> Development -> System tables -> Ecommerce - SKU**.

Please note that the **Custom fields tab** is visible only if there are some custom fields defined.

Tax classes tab

You can specify **Tax classes** for every product - you can choose any number of taxes that apply to the given product.

Volume discounts

On the **Volume discounts** tab in the **Product properties** dialog, you can define discount that applies to the ordered product when the customer purchases specified amount of the product.

For every volume discount line, you need to enter:

- **minimum amount** - number of ordered items from which the discount applies
- **discount value** - relative or absolute discount for the given minimum amount

When the customer updates the number of ordered products, the discount is automatically calculated and the customer is displayed with the final price. For more details please refer to the [Discounts overview](#) chapter.

Options tab

Here you can specify option categories (e.g. size of clothes) - you can choose any number of categories that assign to the given product. Customer is asked to choose her product configuration before the product is added to the shopping cart.

For further information please refer to the [Product options](#) chapter.



Assigning product to document

In Kentico CMS, products are defined separately from the documents. When you want to display a product on your web site, you firstly choose a document that will act as a container for the product and then you assign the given product to the chosen document.

While creating document, you can also choose to create document and product at the same time and product will be assign to the given document automatically.

The fact that products are defined separately enables them to be independent of the document structure of a specific web site. This allows you to use the same product on multiple sites.

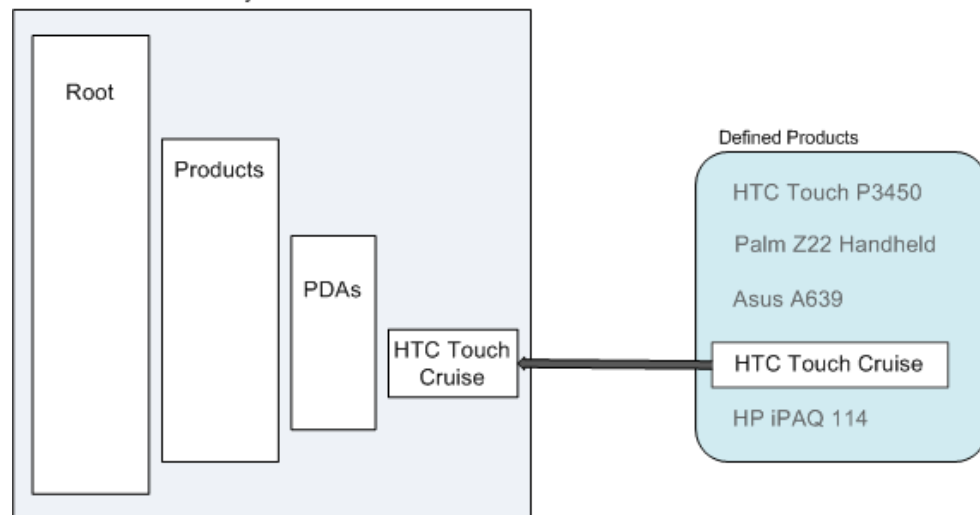

Document structure of your web site.



Please note: Should you want your products to be created automatically or to get its product field value directly from the document field value, please refer to the [Mapping document fields to product properties](#) chapter.

6.5 Product options

You can manage product options at **Kentico CMS Desk -> Tools -> E-commerce -> Product options**

Here you can either create a new option category  [New option category](#) or edit  and delete  the existing one.

Every option category has following properties:

General

Category name - category name displayed to the customer

Selection type - type of selection, a customer use to choose the product option

Display price - if enabled, product option prices will be displayed next to product options





Default option(s) product options which are selected by default before a customer chooses her own one (s)

Description - the description of the category as it is visible to customers

Default record text - the caption of the default option, which is added to the product options collection

Enabled - indicates if the category is enabled

Options

Here you can either add a new product option  [New product option](#) to the current option category or you can edit  or delete  existing options or change their succession   within the current option category.

Product options have the same properties as **Products** with the exception of the volume discounts which cannot be assigned (as well as discount coupon) to a product option.

On contrary with the product price, the product option price can be negative. The product option price is the amount that is either added to or subtracted from the given product price. The product option is sold as an addition to the given product, not as its replacement. If certain discount level applies to the given customer, this discount level applies for the chosen product option as well.

6.6 Manufacturers

The **Manufacturers** dialog at **Kentico CMS Desk -> Tools -> E-commerce -> Manufactures** allows you to manage the list of manufacturers who make the products you sell. This information is optional, so you do not need to supply it. You can use it for your internal records or you can display it on your web site (e.g. you can display a link to the manufacturer's web site where clients can find more details).

Every manufacturer has the following properties:

- **Manufacturer display name** - manufacturer name

- **Homepage** - URL of the internet home page of the manufacturer

- **Enabled** - indicates if the given manufacturer can be used for newly created products

6.7 Suppliers

You can define your suppliers at **Kentico CMS Desk -> Tools -> E-commerce -> Suppliers**. This information is typically used only for your records. This information is optional and you do not need to enter it.

Every supplier has the following properties:

- **Supplier display name** - name of the supplier
- **Supplier e-mail** - supplier e-mail contact
- **Supplier phone** - supplier phone contact
- **Supplier fax** - supplier fax contact
- **Enabled** - indicates if the supplier is active and can be used for newly added products

6.8 Discount coupons

You can define discount coupons at **Kentico CMS Desk -> Tools -> E-commerce -> Discount coupons**. The discount coupon is represented by a special code that is used by the customer on the Shopping Cart page.

Every discount coupon has the following properties:

- **Discount coupon name** - friendly name of the discount displayed to customers and store managers
- **Discount coupon code** - the coupon code that will be used by the customer during the purchase
- **Discount value** - you can choose between absolute and relative discount and you can enter the discount value in the box below
- **Valid from, Valid to** - time period when the discount can be applied

On the **Products** tab, you can choose which products the discount should be applied to or not applied to. Please note that you can assign a discount coupon only to the given product, not to its product options. **Discount coupons** cannot be defined for **Product options**.

For more details please refer to the [Discounts overview](#) chapter.

6.9 Discount levels

You can define discount levels that apply to all products at **Kentico CMS Desk -> Tools -> E-commerce -> Discount levels**. Every customer can be assigned with a discount level. For example, you can assign all Gold Partners with 30% discount on all products they purchase on your web site.

The discount level can be defined on the **Discount levels** tab. A discount level has the following properties:

- **Display name** - the discount level name displayed to the users
- **Code name** - the discount level name used in the code
- **Value** - percentage value of the discount
- **Valid from/to** - time period when the discount level is applied. If you leave both values empty, the discount is time-unlimited.
- **Enabled** - indicates if the discount level should be used

On the **Departments** tab, you can choose the departments on which the discount level can be applied.

Once you define the discount levels, you need to assign them to the customers in the **Customer**

properties dialog, in the **Discount level** drop-down list.

For more details please refer to the [Discounts overview](#) chapter.

6.10 Reports

At **Kentico CMS Desk -> Tools -> E-commerce -> Reports** you can display, save and print following e-commerce statistics:

Numbers of orders per year - number of orders made on the web site in one year

Numbers of orders per month - number of orders made on the web site in one month

Number of orders per day - number of orders made on the web site in one day

Sales per year - sales in one year in your default currency

Sales per month - sales in one month in your default currency

Sales per day - sales in one day in your default currency

Inventory - the inventory list of all products defined in the **Products** tab

Top 100 customers by volume of sales

For more information, please refer to the **Module Reporting** chapter in **Kentico CMS Developer's guide**.

6.11 Configuration

6.11.1 Store settings

Go to **Kentico CMS Desk -> Tools -> E-commerce -> Configuration -> Store Settings** and set the following values:

General tab

- **Default country** - <choose your country or country where you sell most>
- **Minimum amount for free shipping** - the minimum order value when the shipping is not charged
- **Allow anonymous customers** - indicates if customers need to create a user account in your site so that they can make the purchase
- **Use an extra company address** - indicates if the option of providing company address is available in the check out process
- **Require company account information** - indicates if it is compulsory to provide company account information in the check out process
- **Show Organization ID field** - indicates if organization ID field should be displayed
- **Show Tax registration ID field** - indicates if organization ID field (e.g. VAT registration ID) should be displayed
- **Main currency** - default currency use as base for calculation of exchange rates



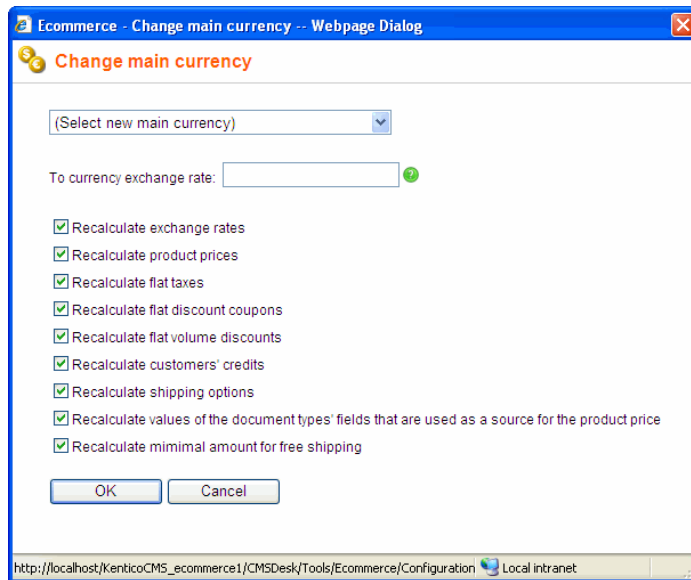

After clicking the **Change** button next to main currency, a new dialog appears. In the dialog, you can select items which should be recalculate according to exchange rate to the new main currency.



Emails tab

- **Send e-commerce e-mails from** - an e-mail address from which the e-mail notifications are sent
- **Send e-commerce e-mails to** - an e-mail address (e.g. merchant's e-mail address) to which the e-mail notifications are sent
- **Send order notification** - indicates if notifications are sent after an order is finished and saved. The e-mail template **E-commerce order notification to customer** is used when sending notification to customer. The e-mail template **E-commerce order notification to administrator** is used when sending notification to administrator.
- **Send payment notification** - indicates if a notification is sent after payment is completed. The e-mail template **E-commerce - Order payment notification to customer** is used when sending notification to customer. The e-mail template **E-commerce - Order payment notification to administrator** is used when sending notification to administrator.

Checkout process tab

Here you can either create a new step  [New step](#) in the checkout process or you can edit  or delete  existing steps or change their succession  .

For more information about purchase process please refer to the [Customizing the purchase process](#) chapter.

6.11.2 Departments

Go to **Kentico CMS Desk -> Tools -> E-commerce -> Configuration -> Departments**. Department is used for organization of your product management efforts - you can specify users who can manage products in the given department. It means you can have a different product manager for e.g. books and for electronics departments.

Please note that the **departments are not the same as product categories** displayed to site visitors.

You can create either only single department and place all products in it or you can create separate departments if you have several product managers.

Every department has these properties:

- **Department display name** - friendly name displayed to users
- **Department code name** - code name used by developers in the code
- **Default tax class for new products** - the tax class that is automatically assigned to the products created in the given department

In the **Users** tab, you can specify the users who can manage products in these departments.

6.11.3 Shipping options

You can manage shipping options at **Kentico CMS Desk -> Tools -> E-commerce -> Configuration -> Shipping options**. Each shipping option has the following properties on the **General** tab:

- **Shipping option display name** - friendly name displayed to customers and store managers
- **Shipping option name** - code name used by developers
- **Shipping option charge** - amount charged for this shipping option (in the main currency)
- **Enabled** - indicates if shipping option is offered to customers

On the **Payment methods** tab of the Shipping option properties dialog, you can choose which payment methods will be available for the given shipping option.

6.11.4 Payment methods

You can manage payment methods at **Kentico CMS Desk -> Tools -> E-commerce -> Configuration -> Payment methods**. Every payment method has the following properties:

- **Payment method display name** – Friendly name (localizable string or simple text) displayed to the users.
- **Payment method code name** – Unique identifier which must be unique within all of the site payment methods.
- **Enabled** – Indicates if payment method could be used for payment.
- **Payment gateway URL** - External payment gateway url or relative path to your document controlled by the Kentico CMS which represents your custom payment processor. It can be parameterized with data macros to evaluate the data fields of the order and related objects.

The following example shows how you can insert finished order ID and customer billing address state code to the payment url, however, you can get any value from the related objects. See **Kentico CMS Database Reference** for detailed column listing of the objects:

```
http://www.SomePaymentGateway.com?orderid={%Order.OrderId%}&state={%BillingAddress.State.StateCode%}
```

{%Order.OrderID%}	Displays the value of specified order data column (COM_Order)
{%ShoppingCart.ShoppingCartID%}	Displays the value of specified shopping cart data column (COM_ShoppingCart)
{%OrderStatus.StatusID%}	Displays the value of specified order status data column (COM_OrderStatus)
{%BillingAddress.AddressID%}	Displays the value of specified billing address data column (COM_Address)
{%BillingAddress.Country.CountryID%}	Displays the value of specified billing address country data column (CMS_Country)
{%BillingAddress.State.StateID%}	Displays the value of specified billing address state data column (CMS_State)
{%ShippingAddress.AddressID%}	Displays the value of specified shipping address data column (COM_Address)
{%ShippingAddress.Country.CountryID%}	Displays the value of specified shipping address country data column (CMS_Country)
{%ShippingAddress.State.StateID%}	Displays the value of specified shipping address state data column (CMS_State)
{%CompanyAddress.AddressID%}	Displays the value of specified company address data column (COM_Address)
{%CompanyAddress.Country.CountryID%}	Displays the value of specified company address country data column (CMS_Country)
{%CompanyAddress.State.StateID%}	Displays the value of specified company address state data column (CMS_State)
{%ShippingOption.ShippingOptionID%}	Displays the value of specified shipping option data column (COM_ShippingOption)
{%PaymentOption.PaymentOptionID%}	Displays the value of specified payment option data column (COM_PaymentOption)
{%Currency.CurrencyID%}	Displays the value of specified currency data column (COM_Currency)
{%Customer.CustomerID%}	Displays the value of specified customer data column (COM_Customer)
{%DiscountCoupon.DiscountCouponID}	Displays the value of specified discount coupon data column (

%	COM_DiscountCoupon)
---	---------------------

- **Payment gateway assembly name** – Name of a library which includes your payment gateway class inside.
- **Payment gateway class name** – Name of a class which represents your custom payment gateway processor.
- **Order status when payment succeeds** – Order status which is set to the existing order when its payment succeeds.
- **Order status when payment fails** – Order status which is set to the existing order when its payment fails.

Please note: the offered payment methods depend on the chosen [shipping option](#). You need to specify this relationship when editing required shipping option. If there is no enabled shipping option all payment methods are offered.

6.11.5 Tax classes

You can manage tax classes at **Kentico CMS Desk -> Tools -> E-commerce -> Configuration -> Tax classes**.

Tax classes represent a customizable system that allows you to configure taxes paid for goods. You can specify different tax classes with different rates for each country. Then you apply these taxes to particular products.

Every tax class has the following properties:

- **Tax class display name** - friendly name displayed to users
- **Tax class code name** - code name used by developers in the code
- **Zero tax if Tax ID is supplied** - indicates if the tax should be calculated as zero (0) if the customer enters the Tax ID. The Tax ID is only displayed during the purchase process if the **Configuration -> Store Settings -> Show Tax registration ID field** box is checked.

On the **Countries** and **States** tab, you can set the value for particular countries (the country is recognized based on the billing address). The tax value can be either percentage (by default) or it can be a flat fee. If both country and state tax are specified, only the state tax is used.

6.11.6 Currencies

The store may offer goods for prices in several currencies. The available currencies can be managed at **Kentico CMS Desk -> Tools -> E-commerce -> Configuration -> Currencies**.

How to configure currencies

1. Enter all currencies you will use and delete or disable (uncheck the box **Enabled**) the currencies that you do not want to use. You will need to enter the following properties:
 - **Currency display name** - the friendly name displayed to site visitors
 - **Currency code name** - the code name used by developers
 - **Currency code** - the official code of the currency used in exchange rates
 - **Currency formatting string** - the format used to display amounts in the given currency - use

{0} expression to insert the value into the formatting text

- **Significant digits** - the number of digits in the price that will be used in the total amount. The value will be rounded if the actual number of decimal digits is higher

- **Enabled** - indicates if the currency should be displayed in the currency drop-down list

2. If applicable, set the new currency as main currency at **Configuration -> General**.

3. If you're using multiple currencies, please specify exchange rates at **Configuration -> Exchange rates**.

6.11.7 Exchange rates

You can configure the exchange rates between the main currency and the alternative currencies at **Kentico CMS Desk -> Tools -> E-commerce -> Configuration -> Exchange rates**. The exchange rates are organized into **Exchange tables** that specify the complete exchange rate table for a given time period. You can define a new exchange table e.g. for every day.

Every exchange table has the following properties:

- **Table display name** - friendly name of the exchange table - e.g. "January 15, 2007 - January 20, 2007"
- **Valid from, Valid to** - time period the exchange table applies to
- **Exchange rates** - here you can enter "how much you have to pay for a single unit of the given currency"

6.11.8 Order status

You can configure various order states at **Kentico CMS Desk -> Tools -> E-commerce -> Configuration -> Order status**. This can be e.g. New -> In progress -> Closed or Canceled. You can also specify their flow using the up/down arrows.

Every status has the following properties:

- **Order status display name** - friendly name displayed to store managers
- **Order status code name** - code name used by developers
- **Order status color** - the color used to highlight the orders in given status in the Orders dialog.
- **Enabled** - indicates whether this status should be used for new orders
- **Send notification** - indicates whether the e-mail notifications are sent to the customer and administrator when status of the existing order is set to the given status. The e-mail template "E-commerce order status notification to customer" is used when sending notification to customer. The e-mail template "E-commerce order status notification to administrator" is used when sending notification to administrator.

Please note: This setting is independent of the **Send order notification** setting at **Kentico CMS Desk -> Tools -> E-commerce -> Configuration -> Store settings -> Emails**. Furthermore, the **Send e-commerce e-mails from** and **Send e-commerce e-mails to** text boxes at **CMSDesk -> Tools -> E-commerce -> Configuration -> Store settings -> Emails** need to have specified values so that you would be able to receive and send notifications.

6.11.9 Public status

You can configure various states of the product displayed on the public site at **Kentico CMS Desk -> Tools -> E-commerce -> Configuration -> Public status**. This can be e.g. "Available", "Accepting pre-orders" or "Not available".

Every status has the following states:

- **Public status display name** - friendly name displayed to store managers
- **Public status code name** - code name used by developers
- **Enabled** - indicates if this status should be used for new orders

This can be e.g. "Available", "Accepting pre-orders" or "Not available".

6.11.10 Internal status

You can configure various states of the product used by store managers to differentiate products at **Kentico CMS Desk -> Tools -> E-commerce -> Configuration -> Internal status**. This can be e.g. "Featured product", "New!" or "Sale". You can then use this information on your web site to display the products e.g. in the "New products" box on your home page.

Every status has the following states:

- **Internal status display name** - friendly name displayed to store managers
- **Internal status code name** - code name used by developers
- **Enabled** - indicates if this status should be used for new orders

This can be e.g. "Featured product", "New!" or "Sale". You can then use this information on your web site to display the products e.g. in the **Featured products** list on your home page.

6.11.11 Invoice

You can customize the invoice (or receipt) design at **Kentico CMS Desk -> Tools -> E-commerce -> Configuration -> Invoice** dialog. You can edit the HTML code representing your invoice here and use special expressions to insert dynamic parts of the invoice.

For example, you can use the **##BILLINGADDRESS##** expression to insert the customer's billing address into the invoice.

You can find a complete list of available dynamic expressions at the bottom of the dialog.

Please note: In Kentico CMS offers you the capability of splitting an invoice into several pages for printing. Should you experience difficulties with the printed design of an invoice in Internet Explorer, try to print it using the Firefox web browser instead.

Invoice		<i>Company logo</i>		
Invoice number:	2	Order date:	4/6/2008	
Supplier	Customer			
Company address	Development Soft 1020 Blueberry Ln. Tucson 85754 USA, Arizona			
Payment option				
Cash on delivery				
Product name	Units	Price/unit	Tax	Subtotal
Configurable PC	1	0.00	0.00	0.00
- Windows Vista Home Premium	1	216.00	0.00	216.00
- CD RW Samsung Black SATA	1	42.00	0.00	42.00
- INTEL Core 2 Quad Q6600 2.40GHz	1	220.00	0.00	220.00
- nVIDIA GEFORCE 6600GTS 512MB	1	440.00	0.00	440.00
- SAMSUNG 500GB SATA	1	139.00	0.00	139.00
- DDR2 1024MB 667MHz	1	30.00	0.00	30.00
- ACER 22"	1	460.00	0.00	460.00
- AUDIGY SE bulk	1	30.00	0.00	30.00
- Repró 5.1	1	60.00	0.00	60.00
- Printer	1	90.00	0.00	90.00
- Scanner	1	69.00	0.00	69.00
Configurable PC	1	0.00	0.00	0.00
- Windows XP Home	1	191.00	0.00	191.00
- CD RW Samsung Black SATA	1	42.00	0.00	42.00
- INTEL Core 2 Quad Q6600 2.40GHz	1	220.00	0.00	220.00
- nVIDIA GEFORCE 6600GTS 512MB	1	440.00	0.00	440.00
- SAMSUNG 500GB SATA	1	139.00	0.00	139.00
- DDR2 1024MB 667MHz	1	30.00	0.00	30.00
- ACER 22"	1	460.00	0.00	460.00
- AUDIGY SE bulk	1	30.00	0.00	30.00
- Repró 5.1	1	60.00	0.00	60.00
- Printer	1	90.00	0.00	90.00
- Scanner	1	69.00	0.00	69.00
Configurable PC	2	0.00	0.00	0.00
- Windows Vista Business	2	270.00	0.00	540.00
- CD RW Samsung Black SATA	2	42.00	0.00	84.00
- INTEL Core 2 Quad Q6600 2.40GHz	2	220.00	0.00	440.00
- nVIDIA GEFORCE 6600GTS 512MB	2	440.00	0.00	880.00
- SAMSUNG 500GB SATA	2	139.00	0.00	278.00
- DDR2 1024MB 667MHz	2	30.00	0.00	60.00
- ACER 22"	2	460.00	0.00	920.00
- AUDIGY SE bulk	2	30.00	0.00	60.00
- Repró 5.1	2	60.00	0.00	120.00

Product name	Units	Price/unit	Tax	Subtotal
- Printer	2	50.00	0.00	100.00
- Scanner	2	69.00	0.00	138.00
Configurable PC	1	0.00	0.00	0.00
- Red Hat Linux	1	55.00	0.00	55.00
- CD RW Samsung Black SATA	1	42.00	0.00	42.00
- INTEL Core 2 Quad Q6600 2.40GHz	1	220.00	0.00	220.00
- nVIDIA GEFORCE 6600GTS 512MB	1	440.00	0.00	440.00
- SAMSUNG 500GB SATA	1	139.00	0.00	139.00
- DDR2 1024MB 667MHz	1	30.00	0.00	30.00
- ACER 22"	1	460.00	0.00	460.00
- AUDIGY SE bulk	1	30.00	0.00	30.00
- Repró 5.1	1	80.00	0.00	80.00
- Printer	1	90.00	0.00	90.00
- Scanner	1	69.00	0.00	69.00
Total shipping:				\$ 5.00
Total price:				\$ 9197.00
Tax summary:				

6.12 Enabling the e-commerce module

You may need to enable the e-commerce product before you start using it. Go to **Kentico CMS Site Manager -> Settings -> E-commerce**, select your web site in the drop-down list and check the box **"Product" tab enabled**. Click **Save**.

It will ensure that documents can be marked as products in the **Kentico CMS Desk -> Content** section.

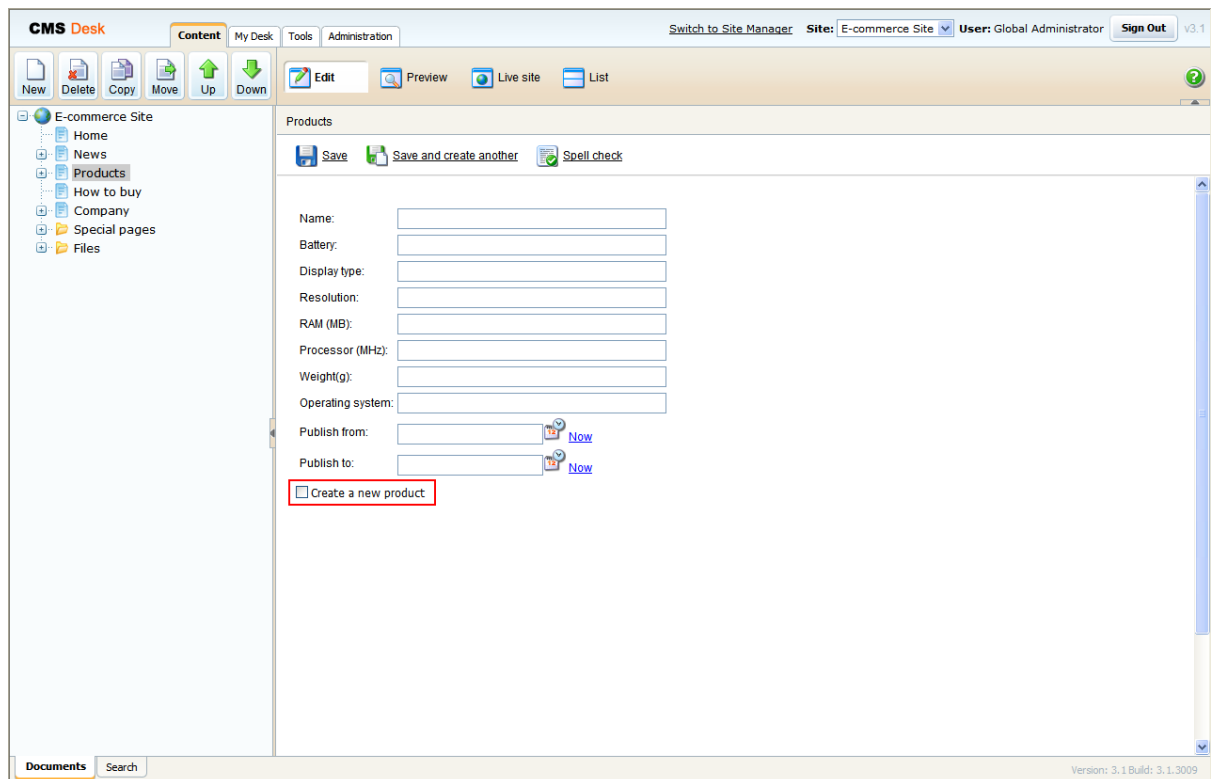

CMS Desk | Content | My Desk | Tools | Administration | Switch to Site Manager | Site: E-commerce Site | User: Global Administrator | Sign Out | v3.1

Document is a product

General | Tax classes | Volume discounts | Options

Product name:
 Product number:
 Description:

Let your fingers guide you with the HTC Touch™, the world's first phone to feature intuitive touch screen technology. Surf the web with Internet Explorer®, send and receive email from accounts like Hotmail® and Yahoo!®, Chat on Messenger and send photos to your own web space through Windows Live™. Optimised for entertainment, the HTC Touch lets you enjoy your favourite music and movie clips through the integrated media suite. You also have the versatility to upload, store and share your media files with microSD™ removable memory. With Windows Mobile® 6, the HTC Touch also provides instant access to your Outlook® email and the most popular Microsoft® Office applications. Feel the difference with intuitive TouchFLO™ screen technology for finger and stylus input. Simple user interface for quick dialing, navigation and launching applications. Surf the web with ease on the large 2.8" touch screen with Internet Explorer®. Enjoy music and movie clips with HTC's Audio Manager and Windows Media® Player. Chat on Messenger, send and receive Hotmail® and send

Price:
 Enabled:
 Department:
 Manufacturer:
 Supplier:
 Public status:
 Internal status:

Documents | Search | Version: 3.1 Build: 3.1.3009

6.13 Security configuration

You can configure the following permissions for the E-commerce module in the **CMS Site Manager** -> **Administration** -> **Permissions** -> <select the "Module: E-commerce"> permission matrix:

- **Display module** - indicates if the module is visible in the UI.
- **Modify configuration** - modify (create/update/delete) access to the Configuration section.
- **Modify data** - modify (create/update/delete) access to the rest of the E-commerce module dialogs, including the Content/Product dialog.
- **Read configuration** - read-only access to the Configuration section.
- **Read data** - read-only access to the rest of the E-commerce module dialogs, including the Content/Product dialog.

Moreover, you can assign store managers to particular [departments](#), so that they cannot accidentally modify products they are not responsible for.

You can also use document-level permissions if you need to restrict access to modifications of product documents in the content tree.

The screenshot shows the CMS Site Manager Administration interface. The left sidebar contains a tree view with 'Permissions' selected. The main content area is titled 'Permissions' and shows configuration options for Site (Corporate Site), Permission type (Modules), and Permission matrix (E-commerce). Below these options is a table showing permissions for various user roles.

	Display module	Modify configuration	Modify data	Read configuration	Read data
Authenticated users	<input type="checkbox"/>	<input type="checkbox"/>	<input type="checkbox"/>	<input type="checkbox"/>	<input type="checkbox"/>
CMS Community Administrators	<input type="checkbox"/>	<input type="checkbox"/>	<input type="checkbox"/>	<input type="checkbox"/>	<input type="checkbox"/>
CMS Designers	<input type="checkbox"/>	<input type="checkbox"/>	<input type="checkbox"/>	<input type="checkbox"/>	<input type="checkbox"/>
CMS Desk Administrators	<input checked="" type="checkbox"/>	<input checked="" type="checkbox"/>	<input checked="" type="checkbox"/>	<input checked="" type="checkbox"/>	<input checked="" type="checkbox"/>
CMS Editors	<input type="checkbox"/>	<input type="checkbox"/>	<input type="checkbox"/>	<input type="checkbox"/>	<input type="checkbox"/>
CMS Readers	<input type="checkbox"/>	<input type="checkbox"/>	<input type="checkbox"/>	<input type="checkbox"/>	<input type="checkbox"/>
Everyone	<input type="checkbox"/>	<input type="checkbox"/>	<input type="checkbox"/>	<input type="checkbox"/>	<input type="checkbox"/>
Gold Partners	<input type="checkbox"/>	<input type="checkbox"/>	<input type="checkbox"/>	<input type="checkbox"/>	<input type="checkbox"/>
Live ID users	<input type="checkbox"/>	<input type="checkbox"/>	<input type="checkbox"/>	<input type="checkbox"/>	<input type="checkbox"/>
Not authenticated users	<input type="checkbox"/>	<input type="checkbox"/>	<input type="checkbox"/>	<input type="checkbox"/>	<input type="checkbox"/>
Silver Partners	<input type="checkbox"/>	<input type="checkbox"/>	<input type="checkbox"/>	<input type="checkbox"/>	<input type="checkbox"/>

6.14 Countries and states

Various dialogs through-out the e-commerce module and the check-out process display a list of countries and states. You can manage the list of available countries and states at **Site Manager -> Development -> Countries**. These settings need to be pre-defined by some of the global administrators.

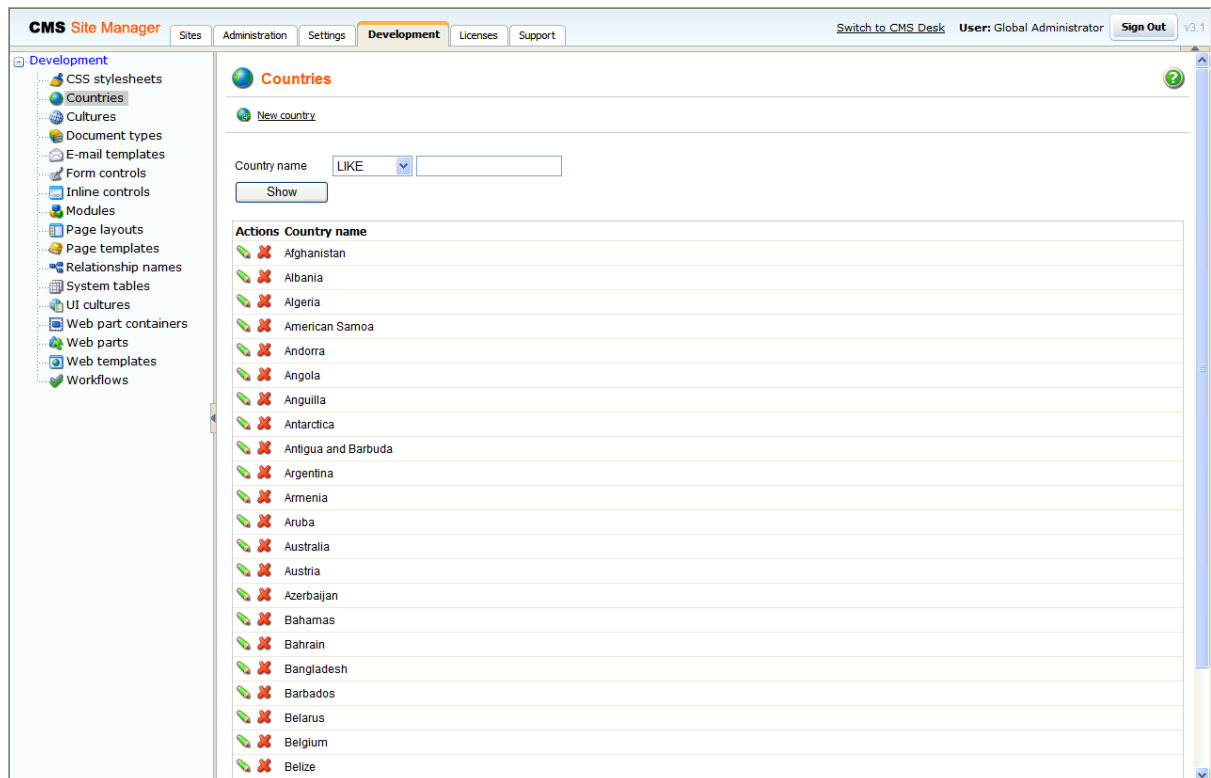

6.15 E-commerce and multi-site configuration

When you run multiple sites from a single Kentico CMS interface, it's important to consider that some e-commerce settings are shared by all web sites. Thus, it's recommended that you use the multi-site support only for a single company that manages multiple e-commerce stores with shared settings.

The following settings are **shared** among web sites:

- orders
- customers
- products
- product options
- manufacturers
- suppliers
- discounts
- departments
- tax classes
- currencies
- exchange rates
- order status

- public status
- internal status

The following settings are **site-specific**:

- store settings
- shipping options
- payment methods
- invoice template

6.16 Mapping document fields to product properties

You can map document fields into the product fields. Then, when the document is modified, the values are automatically updated in its product properties.

Please note that you cannot map product fields to document fields. The mapping doesn't work the other way round.

You can map the fields in the **Site Manager -> Development -> Document Types -> <select document type> -> E-commerce** dialog.

You can also choose to automatically mark the document as a product when a new document of the given type is created. In this case, you need to check the box **Automatically create product when a new document is created** and choose the **default department** to which the product will be assigned. In this case, you need to map at least the **Product name** and **Product price** source fields in the drop-down lists above.

The screenshot shows the 'Document Type Properties' dialog in the Kentico CMS Site Manager. The 'E-commerce' tab is active, and the 'Product - Camera' document type is selected. The dialog contains the following fields:

Product property	Document field source
Product name source:	CameraName
Product image source:	(none)
Package weight source:	(none)
Package height source:	(none)
Package width source:	(none)
Package depth source:	(none)
Product price source:	(none)
Product description source:	(none)

Below the mapping table, there is a checkbox labeled 'Automatically create product when a new document is created' which is currently unchecked. Underneath this checkbox is a dropdown menu for 'Default department for new product' with 'Cameras' selected. An 'OK' button is located at the bottom of the dialog.

6.17 Sitemanager settings

E-commerce

You can set following e-commerce module properties at **Site Manager -> Settings -> E-commerce**:

- **"Product" tab enabled** - Please see the [Enabling the e-commerce module](#) chapter for more details.
- **Default product image URL** - Default product image URL (virtual path). This image is used when product image is not specified.
- **My account URL** - My account page URL (virtual path)
- **Shopping cart URL** - Shopping cart page URL (virtual path)
- **Wishlist URL** - Wishlist page URL (virtual path)

Payment Gateway - Authorize.NET

At **Site Manager -> Settings -> Payment Gateway - Authorize.NET** you can set following properties:

- **API Login**
- **Test mode**
- **Transaction key**

For more information please see the [Authorize.NET configuration](#) chapter.

Payment Gateway - PayPal

At **Site Manager -> Settings -> Payment Gateway - PayPal** you can set following properties:

- **Business**
- **Cancel Return Url**
- **Notify Url**
- **Return Url**

For more information please see the [PayPal configuration](#) chapter.

6.18 Web.config settings

In the **web.config** file, you can set appropriate keys in the following location to modify functionality of the e-commerce module:

```
<configuration>
<appSettings>
<add key="CMSUseCustomEcommerceProviders" value="false" />
.
.
.
</appSettings>
</configuration>
```

The following keys can be set:

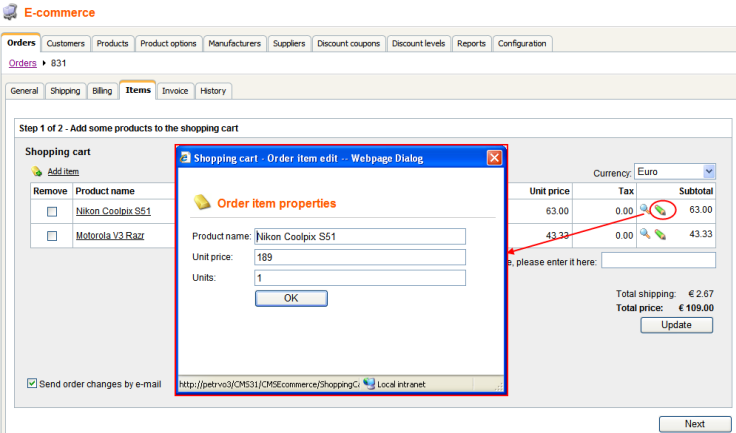
CMSUseCurrentSKUData	<p>If set to false (default value), the name and price of the existing order item are used while editing order items.</p> <p>If set to true, the current product name and product price of a product are used while editing order items.</p>
CMSEnableOrderItemEditing	<p>If set to true, it is possible to edit order item price or order item name after the order is made. Please note that you can make these changes only if the CMSUseCurrentSKUData key is set to false at the same time.</p>  <p>It is set to false by default.</p>
CMSUseMetaFileForProductImage	<p>If set to true (default value), user is asked to choose a product image from the file system of her computer. The product image is uploaded to server and saved as a metafile of the given product (product image document of type cms.file is not created). The path to the given metafile is saved as a product image path (SKUImagePath).</p> <p>If set to false, user is asked to choose a document of type cms.file to become a product image. The path to the selected document is saved as a product image path (SKUImagePath).</p>
CMSUseCustomEcommerceProviders	<p>For more information please see the Using custom providers chapter,</p>
CMSShoppingCartExpirationPeriod	<p>Specify the number of days after which a shopping cart is considered to be old and is erased with the Deleting old shopping carts task.</p>

Custom web.config settings

You can add your own settings (key and its value) into the **web.config** file. To work with these settings, use methods of the **CMS.SettingsProvider.SettingsKeyProvider** class.

The following example shows how to get the value (type of double) of the key named **MyCustomKey**.

```
double value = CMS.SettingsProvider.SettingsKeyProvider.GetDoubleValue("MyCustomKey")
```

6.19 Localization settings

KenticoCMS supports localization of its features through localization expressions.

In the e-commerce module, the following features can be localized meaning that you can set their value either as plain text or as the macro expression.

- **Product display name**
- **Product option display name**
- **Product option category display name**
- **Payment method display name**
- **Shipping option display name**
- **Currency display name**
- **Tax class display name**
- **Discount coupon display name**
- **Discount level display name**
- **Order status display name**
- **Public status display name**
- **Country display name**
- **State display name**

Following example should suggest you how to supply a localized value into the document type transformation code or into your own aspx page.

1. Creating localized expressions

At CMS Site Manager -> Development -> UI cultures you can create a new string for the given cultures.

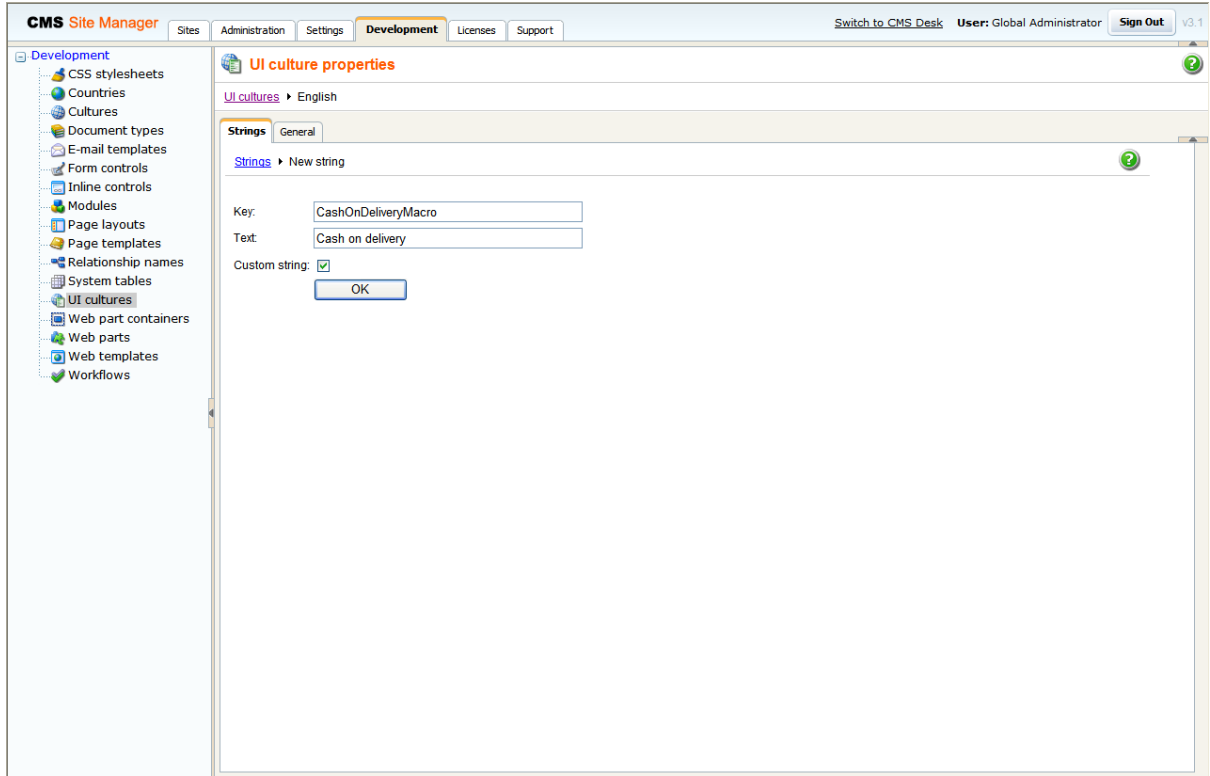

2. Displaying localized expressions

For instance, if you have defined new string with the **Key** attribute *CashOnDeliveryMacro* and **Text** attribute *Cash on delivery* for the English culture and *Comptant à la livraison* for the french culture, using localization method **CMS.GlobalHelper.ResHelper.LocalizeString("{key}")** will result in displaying **Cash on delivery** to the English-speaking person and **Comptant à la livraison** to the French-speaking person.

The screenshot shows the 'E-commerce' configuration interface. The 'Configuration' tab is active, and the 'Payment method properties' section is selected. The 'Payment method' dropdown is set to 'cashondeliverymacro'. The 'Payment method display name' field contains the macro '{CashOnDeliveryMacro\$}' and is highlighted with a red border. The 'Payment method code name' is 'cashOnDelivery', and the 'Enabled' checkbox is checked. Under 'Payment gateway settings', there are empty fields for 'Payment gateway URL', 'Payment gateway assembly name', and 'Payment gateway class name'. The 'Order status when payment succeeds' and 'Order status when payment fails' are both set to '(leave current order status)'. An 'OK' button is at the bottom.

For further information on the localization macros please refer to the **Localization Expressions** and **Appendix A - Macro expressions** chapters in **Kentico CMS Developer's Guide**.

6.20 Customizing invoice and e-mail templates

For your invoice and e-mail templates, you can use a whole range of pre-defined and data macros as you can find them at **CMSDesk -> Tools -> Ecommerce -> Configuration -> Invoice**.

Pre-defined macros

Should you want to replace the current pre-defined macros, you need to enable the usage of the custom e-commerce provider (see [Using custom providers](#) for more details) and replace the appropriate method from [CustomOrderInfoProvider](#).

Macro	Description	Method
##BILLINGADDRESS##	Displays customer address	<code>string GetAddress(int addressId)</code>
##COMPANYADDRESS##	Displays company address	<code>string GetAddress(int addressId)</code>
##SHIPPINGADDRESS##	Displays shipping address	<code>string GetAddress(int addressId)</code>
##PAYMENTOPTION##	Displays payment method	<code>string GetPaymentOption(int paymentId)</code>
##SHIPPINGOPTION##	Displays shipping option	<code>string GetShippingOption(int shippingId)</code>
##INVOICENUMBER##	Displays invoice number	<code>string GetInvoiceNumber(object order)</code>
##ORDERDATE##	Displays order date	<code>string GetOrderDate(object order)</code>
##ORDERNOTE##	Displays order note	<code>string GetOrderNote(object order)</code>
##PRODUCTLIST##	Displays list of ordered products	<code>string GetProductList(DataTable dt, object currency, bool renderDiscount)</code>
##TOTALSHIPPING##	Displays total shipping for order	<code>string GetTotalShipping(double value, object currency)</code>
##TOTALPRICE##	Displays total price for order	<code>string GetTotalPrice(double value, object currency)</code>
##TAXRECAPITULATION##	Displays list of all taxes used in order	<code>string GetTaxRecapitulation(DataTable dt, object currency)</code>
##TAXREGISTRATIONID##	Displays customer tax registration ID	<code>string GetTaxRegistrationID(object customerObj)</code>
##ORGANIZATIONID##	Displays customer organization ID	<code>string GetOrganizationID(object customerObj)</code>

Data macros

You can use data macros to evaluate the data fields of the order and related objects. See 'Kentico CMS Database Reference' for detailed column listing of the objects.

Following example displays code of the customer billing address state, however, you can get any value from the related objects: {`%BillingAddress.State.StateCode%`}

Macro	Description
{ <code>%Order.OrderID%</code> }	Displays the value of specified order data column (COM_Order)
{ <code>%ShoppingCart.ShoppingCartID%</code> }	Displays the value of specified shopping cart data column (COM_ShoppingCart)
{ <code>%OrderStatus.StatusID%</code> }	Displays the value of specified order status data column (COM_OrderStatus)
{ <code>%BillingAddress.AddressID%</code> }	Displays the value of specified billing address data column (COM_Address)
{ <code>%BillingAddress.Country.CountryID%</code> }	Displays the value of specified billing address country data column (CMS_Country)
{ <code>%BillingAddress.State.StateID%</code> }	Displays the value of specified billing address state data column (CMS_State)
{ <code>%ShippingAddress.AddressID%</code> }	Displays the value of specified shipping address data column (COM_Address)
{ <code>%ShippingAddress.Country.CountryID%</code> }	Displays the value of specified shipping address country data column (CMS_Country)
{ <code>%ShippingAddress.State.StateID%</code> }	Displays the value of specified shipping address state data column (CMS_State)
{ <code>%CompanyAddress.AddressID%</code> }	Displays the value of specified company address data column (COM_Address)
{ <code>%CompanyAddress.Country.CountryID%</code> }	Displays the value of specified company address country data column (CMS_Country)
{ <code>%CompanyAddress.State.StateID%</code> }	Displays the value of specified company address state data column (CMS_State)
{ <code>%ShippingOption.ShippingOptionID%</code> }	Displays the value of specified shipping option data column (COM_ShippingOption)
{ <code>%PaymentOption.PaymentOptionID%</code> }	Displays the value of specified payment option data column (COM_PaymentOption)
{ <code>%Currency.CurrencyID%</code> }	Displays the value of specified currency data column (COM_Currency)
{ <code>%Customer.CustomerID%</code> }	Displays the value of specified customer data column (COM_Customer)
{ <code>%DiscountCoupon.DiscountCouponID%</code> }	Displays the value of specified discount coupon data column (COM_DiscountCoupon)

Custom macros

Following example shows how you can display customer total credit and current time in invoice or e-mails, however you can define your own custom macros.

Please refer to the **Appendix A - Macro expressions** chapter in **Kentico CMS Developer's Guide** for more details.

```

using System;
using CMS.GlobalHelper;

public static string ResolveCustomMacro(MacroResolver sender, string expression, out bool match)
{
    match = false;
    string result = expression;

    //
    // Custom macro examples
    //
    switch (expression.ToLower())
    {
        // Display customer total credit, macro in template: {#totalcredit#}
        case "totalcredit":

            match = true;

            // Get shopping cart object from resolver
            CMS.Ecommerce.ShoppingCartInfo cartObj = sender.SourceObject as
            CMS.Ecommerce.ShoppingCartInfo;
            if ((cartObj != null) && (cartObj.ShoppingCartCustomerID > 0))
            {
                // Get customer total credit in default currency
                double totalCredit =
                CMS.Ecommerce.CreditEventInfoProvider.GetCustomerTotalCredit(cartObj.ShoppingCartCustomerID);

                CMS.Ecommerce.CurrencyInfo currentCurrency = null;
                double currentRate = 1.0;

                // Use shopping cart currency and its exchange rate
                if (cartObj.CurrencyInfoObj != null)
                {
                    currentCurrency = cartObj.CurrencyInfoObj;
                    currentRate = cartObj.ExchangeRate;

                    // Apply exchange rate
                    totalCredit =
                    CMS.Ecommerce.ExchangeTableInfoProvider.ApplyExchangeRate(totalCredit, currentRate);
                }
                // Use default currency
                else
                {
                    currentCurrency = CMS.Ecommerce.CurrencyInfoProvider.GetMainCurrency();
                }

                // Round value
                totalCredit =
                CMS.Ecommerce.CurrencyInfoProvider.RoundTo(totalCredit, currentCurrency);

                // Return formatted value
                result =
                CMS.Ecommerce.CurrencyInfoProvider.GetFormattedPrice(totalCredit, currentCurrency);
            }
            break;
    }
}

```

```
// Display current date and time, macro in template: {#currenttime#}
case "currenttime":
    result = DateTime.Now.ToString();
    break;
}
return result;
}
```

E-mail templates

You can manage e-mail templates at **CMS Site Manager -> Development -> E-mail templates**.

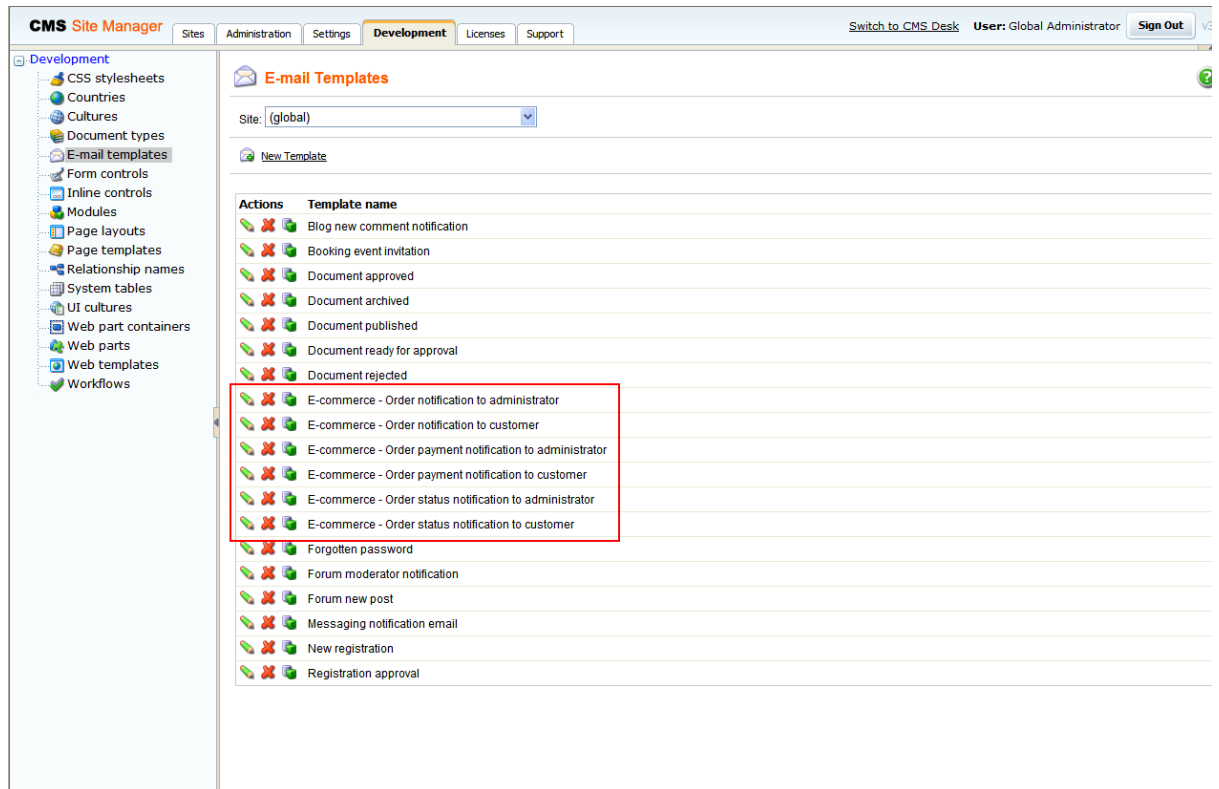

Customizing e-mail subject

Beside e-mail templates, you can use the very same macros in subject of an e-mail. All you have to do is change the appropriate localization strings as specified in the table below. You can change the given localization strings at **<your web project folder>/CMSResources/CMS.<given UI culture code >.resx** (for default culture it's **CMS.resx**)

E-mail template	E-mail subject localization string
order notification to administrator	ordernotification.administratorsubject
order notification to customer	ordernotification.customersubject
order payment notification to administrator	orderpaymentnotification.administratorsubject
order payment notification to customer	orderpaymentnotification.customersubject
order status notification to administrator	orderstatusnotification.administratorsubject
order status notification to customer	orderstatusnotification.customersubject

Following example shows how to customize subject of the order notifications which are sent to administrator:

1. Go to `<your web project folder>/CMSResources/` and open the `CMS.resx` file.
2. Find the `ordernotification.administratorsubject` key and change its value to `Order with ID {%Order.OrderID%} - {%OrderStatus.StatusDisplayName%}` so that the given part of code look in the following way.

```
<data name="ordernotification.administratorsubject" xml:space="preserve">
  <value>
    Order with ID {%Order.OrderID%} - {%OrderStatus.StatusDisplayName%}
  </value>
  <comment>IsNotCustom</comment>
</data>
```

This will include information about order ID and order status in the subject of an e-mail send to the administrator.

Default settings of the e-mail subjects

When new order is made or items of the existing one are changed:

E-mail subject string	Default value
<code>ordernotification.administratorsubject</code>	<code>Order: {%Order.OrderInvoiceNumber%}</code>
<code>ordernotification.customersubject</code>	<code>Your order: {%Order.OrderInvoiceNumber%}</code>

When payment is received:

E-mail subject string	Default value
<code>orderpaymentnotification.administratorsubject</code>	<code>Order {%Order.OrderInvoiceNumber%}: Payment received</code>
<code>orderpaymentnotification.customersubject</code>	<code>Your order {%Order.OrderInvoiceNumber%}: Payment received</code>

When status of the existing order is changed:

E-mail subject string	Default value
<code>orderstatusnotification.administratorsubject</code>	<code>Order {%Order.OrderInvoiceNumber%}: {%OrderStatus.</code>

	StatusDisplayName%}
orderstatusnotification.customersubject	Your order {%Order.OrderInvoiceNumber%}: {%OrderStatus.StatusDisplayName%}

6.21 Using product inventory

Kentico CMS allows you to manage your product inventory at **CMS Desk -> Tools -> E-commerce -> Products**. Here, you can quickly check if a product is available and how many items do you have in stock.

The screenshot shows the 'Products' management page in the Kentico CMS E-commerce module. The interface includes a sidebar with navigation options and a main content area with a 'Products' table. The table has the following columns: Actions, Product name, Product number, Product price, Available items, Public status, Internal status, and Enabled. A red box highlights the 'Available items' column, which shows the stock quantity for each product. The table lists various products such as Acer Aspire, Apple iPhone, and HP Pavilion, with their respective prices and stock levels.

Actions	Product name	Product number	Product price	Available items	Public status	Internal status	Enabled
	Acer Aspire 3105WLMi	941		2			True
	Acer configurator	899		2			True
	Acer configurator	899		0			True
	Acer Extensa 7620G	99		0			True
	Apple iPhone	499		0		Show as featured product	True
	Apple MacBook Air	2094		2			True
	Asus A639	470		1			True
	Asus F3U AP059C	999		1			True
	Canon Digital Rebel XTi	597		3		Show as featured product	True
	Canon PowerShot A720 IS	195		100			True
	Compaq Presario	659		0			True
	Configurable PC	0		0			True
	Creative ZEN	150		0		Show as featured product	True
	Creative Zen Stone	50		0			True
	Emeton M6 Cult	145		0			True
	Emgeton M7 Cult	215		0		Show as featured product	True
	Force PC	749		0			True
	HP configurator	999		0			True
	HP iPAQ 114	389		0			True
	HP iPAQ hx2795 Pocket PC	415		0			True
	HP Pavilion dv6680	1290		0		Show as featured product	True
	HP Pavilion DV9730US	1099		0			True
	HP Pavilion PC a6140	1399		0			True
	HTC Touch P3450	514		0			True
	iPod Classic	250		1			True

There are two ways you can handle products in your inventory:

- 1.) Sell a product only if they are some available items in stock at **CMS Desk -> Tools -> E-commerce -> Products**.

2.) Always sell a product no matter if there are any available items in stock.

You can distinguish between these two by checking the **Sell only if items are available** checkbox either at **CMS Desk -> Tools -> E-commerce -> Products -> <edit given product> -> General** or on the **Product** tab of the product chosen in the content tree.

The screenshot shows the 'Product properties' form for 'Apple MacBook Air' in the 'General' tab. The form includes fields for Price (2094), Enabled (checked), Department (Hardware), Manufacturer (Apple), Supplier (none), Public status (none), Internal status (none), and Availability (days) (0). There is also a field for Product image URL with a small image thumbnail. Below these are fields for Package weight (1.36), Package height, Package width, and Package depth. The 'Inventory' section has an 'Available items' field with the value 2. The 'Sell only if items are available' checkbox is highlighted with a red box.

1. Sell product only if there are available items in stock

For enabling this option, you have to enter the number of available items into the **Available items** text box and check the **Sell only if items are available** checkbox. An order is accepted only if the number of ordered items is no greater than the number of available items.

Available items:

Sell only if items are available:

The sufficiency of the available items is checked every time a user does one of the following:

- Add product to the **shopping cart**
- Click the **Update** button in the shopping cart
- Click the **Checkout** button in the shopping cart
- Click the **Order now** button in the Order Preview

If you want to buy a product with product options, the chosen product and product options have to be enabled and there has to be sufficient number of available items of the given product with the given product option. Otherwise the error message appears.

Step 1 of 6 - Add some products to the shopping cart



Shopping cart

Currency: U.S. Dollar

Remove	Product name	Units	Unit price	Tax	Subtotal
<input type="checkbox"/>	Acer Aspire 3105WLMi The product is currently not available in required quantity. The quantity was set to maximum available quantity, which is 2.	2	941.00	0.00	1882.00

If you have a coupon code, please enter it here:

Total shipping: \$ 8.00
 Total price: **\$ 1890.00**

Please note that you can check the **Sell only if items are available** checkbox for product options as well. You can set check the **Sell only if items are available** checkbox and enter the number of available items for product options at **CMS Desk -> Tools -> E-commerce -> Products Options -> <edit option category> -> Options -> <edit product options>**.

The screenshot displays the Kentico CMS 5.0 E-commerce administration interface. The main window is titled "E-commerce" and shows the "Option category properties" for "Cell phones accessories" and the "Product options" for "Car charger". The "General" tab is selected, and the "Inventory" section is highlighted with a red box. The "Inventory" section contains the following fields:

Inventory	
Available items:	<input type="text" value="2"/>
Sell only if items are available:	<input checked="" type="checkbox"/>

The "General" section includes fields for Price (5), Enabled (checked), Department (Phones), Manufacturer (none), Supplier (none), Public status (none), Internal status (none), Availability (days) (0), and Product image URL (with Select... and Clear buttons). The "Package" section includes fields for Package weight, Package height, Package width, and Package depth. The "Tax classes" section is also visible.

If the checkbox is checked, there has to be the sufficient quantity of the given product option in stock so that an order is accepted. Otherwise the error message appears.

Step 1 of 6 - Add some products to the shopping cart



Shopping cart

Currency: U.S. Dollar

Remove	Product name	Units	Unit price	Tax	Subtotal
<input type="checkbox"/>	Motorola V3 Razzr	<input type="text" value="10"/>	130.00	0.00	1300.00
	- Car charger <i>The product is currently not available in required quantity. The maximum available quantity is 2.</i>	10	5.00	0.00	50.00

If you have a coupon code, please enter it here:

Total shipping: \$ 0.00
 Total price: \$ 1350.00

Please note that the very same check is made anytime a user edit the already existing order. When an item is removed from the order, it is added back to stocked items.

2. Always sell product

When the **Sell only if items available** checkbox is unchecked, an order is processed disregarding the number of available items of the given product or product option. Therefore, a customer can order more items than it is readily available in stock. Should that happen, the number of available items will be negative. Therefore, you'll know exactly how many items do you need to order to meet demands.

Please note: You can check the number of available items in stock at **CMSDesk -> Tools -> Ecommerce -> Reports -> Inventory** as well.

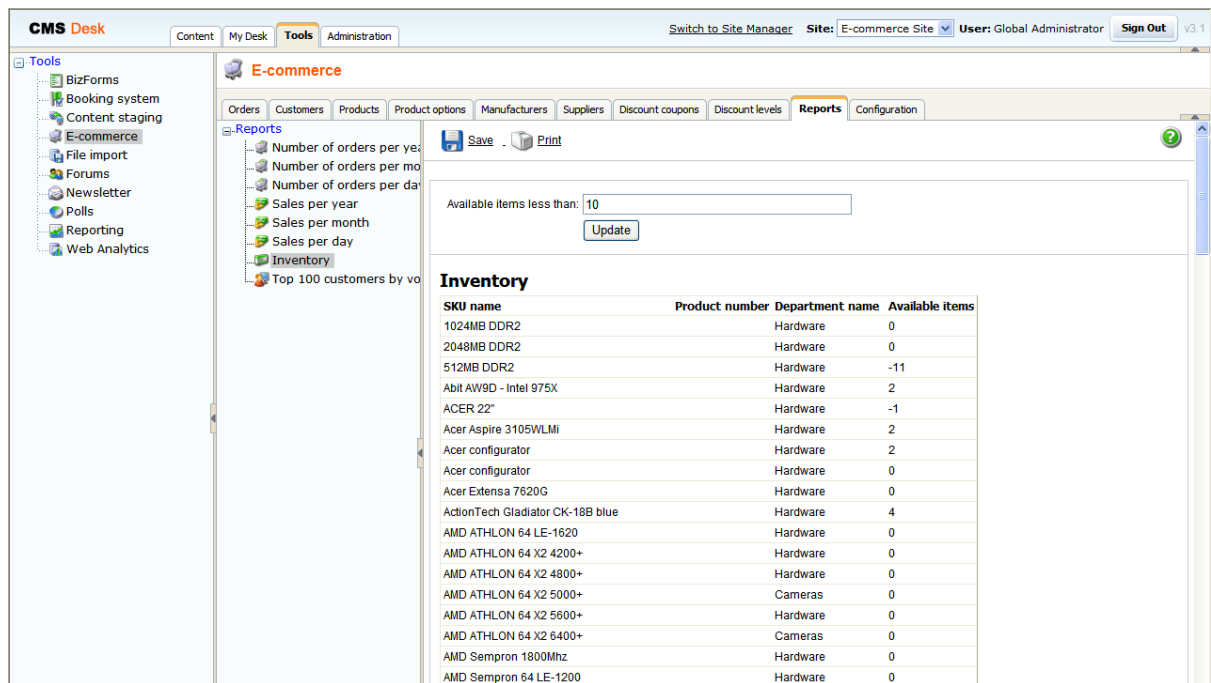

The screenshot shows the CMS Desk interface with the 'E-commerce' module selected. The 'Reports' section is active, and the 'Inventory' report is displayed. The report shows a list of SKUs, product numbers, department names, and available items. The 'Available items' column shows values ranging from 0 to -11.

SKU name	Product number	Department name	Available items
1024MB DDR2		Hardware	0
2048MB DDR2		Hardware	0
512MB DDR2		Hardware	-11
Abit AW9D - intel 975X		Hardware	2
ACER 22"		Hardware	-1
Acer Aspire 3105WLMi		Hardware	2
Acer configurator		Hardware	2
Acer configurator		Hardware	0
Acer Extensa 7620G		Hardware	0
ActionTech Gladiator CK-18B blue		Hardware	4
AMD ATHLON 64 LE-1620		Hardware	0
AMD ATHLON 64 X2 4200+		Hardware	0
AMD ATHLON 64 X2 4800+		Hardware	0
AMD ATHLON 64 X2 5000+		Cameras	0
AMD ATHLON 64 X2 5600+		Hardware	0
AMD ATHLON 64 X2 6400+		Cameras	0
AMD Sempron 1800Mhz		Hardware	0
AMD Sempron 64 LE-1200		Hardware	0







6.22 Discounts overview

In the Kentico CMS E-commerce module, you can define three different types of discounts for your customers:

- **Discount coupons** - discount from the price of the specified products. For more details see the [Discount coupons](#) chapter.
- **Discount levels** - discount that is assigned to the customer for all her purchases. For more details see the [Discount levels](#) chapter.
- **Volume discount** - discount assigned to the product that applies when the customer purchases specified amount of the given product. For more details see the [Products](#) chapter.

In the following examples, we purchase five units of **Apple MacBook Air** with a total price of \$10470 without any discount. Each example demonstrates where you can specify the given type of discount and how it affects the total price of the purchase.

Step 1 of 6 - Add some products to the shopping cart

 →
  →
  →
  →
  →
 

Shopping cart

Currency: U.S. Dollar

Remove	Product name	Units	Unit price	Tax	Subtotal
<input type="checkbox"/>	Apple MacBook Air	<input type="text" value="5"/>	2094.00	0.00	10470.00

If you have a coupon code, please enter it here:

Total shipping: \$ 0.00
Total price: \$ 10470.00

Continue shopping

Check out

Discount coupons

You can create a new discount coupon or edit existing ones at **CMS Desk -> Tools -> E-commerce -> Discount coupons**.

The screenshot displays the Kentico CMS 5.0 E-commerce interface. The top navigation bar includes 'CMS Desk', 'Content', 'My Desk', 'Tools', and 'Administration'. The user is logged in as 'Global Administrator' on the 'E-commerce Site'. The left sidebar lists various tools, with 'E-commerce' selected. The main content area is titled 'E-commerce' and contains a sub-menu with 'Orders', 'Customers', 'Products', 'Product options', 'Manufacturers', 'Suppliers', 'Discount coupons', 'Discount levels', 'Reports', and 'Configuration'. The 'Discount coupons' sub-menu is active, showing a 'New discount coupon' form. The form fields are as follows:

- Discount coupon name:
- Discount coupon code:
- Discount value: Absolute discount Relative discount
- Valid from: [Now](#)
- Valid to: [Now](#)

An 'OK' button is located at the bottom of the form.

While making purchase, a customer is required to enter a coupon code into the given text box to make use of it. The given discount is subtracted from the product price.

Step 1 of 6 - Add some products to the shopping cart



Shopping cart

Currency: U.S. Dollar

Remove	Product name	Units	Unit price	Unit discount	Tax	Subtotal
<input type="checkbox"/>	Apple MacBook Air	<input type="text" value="5"/>	2094.00	100.00	0.00	9970.00

If you have a coupon code, please enter it here:

Total shipping: \$ 0.00
Total price: \$ 9970.00

Discount levels

You can set up a new discount level or edit existing ones at **CMS Desk -> Tools -> E-commerce -> Discount levels**.

The screenshot displays the Kentico CMS 5.0 E-commerce interface. The top navigation bar includes 'CMS Desk', 'Content', 'My Desk', 'Tools', and 'Administration'. The 'Tools' menu is expanded, showing 'E-commerce' as the selected option. The 'E-commerce' sub-menu is also expanded, with 'Discount levels' selected. The main content area shows the 'New discount level' configuration form. The form includes the following fields and options:

- Display name:** VIP customers
- Code name:** VIPcustomers
- Value:** 10 %
- Valid from:** 4/16/2008 10:55:01 (with a 'Now' button)
- Valid to:** (empty field) (with a 'Now' button)
- Enabled:**
- OK** button

After creating a new discount level, you have to assign it to those users who you want to take advantage of it.

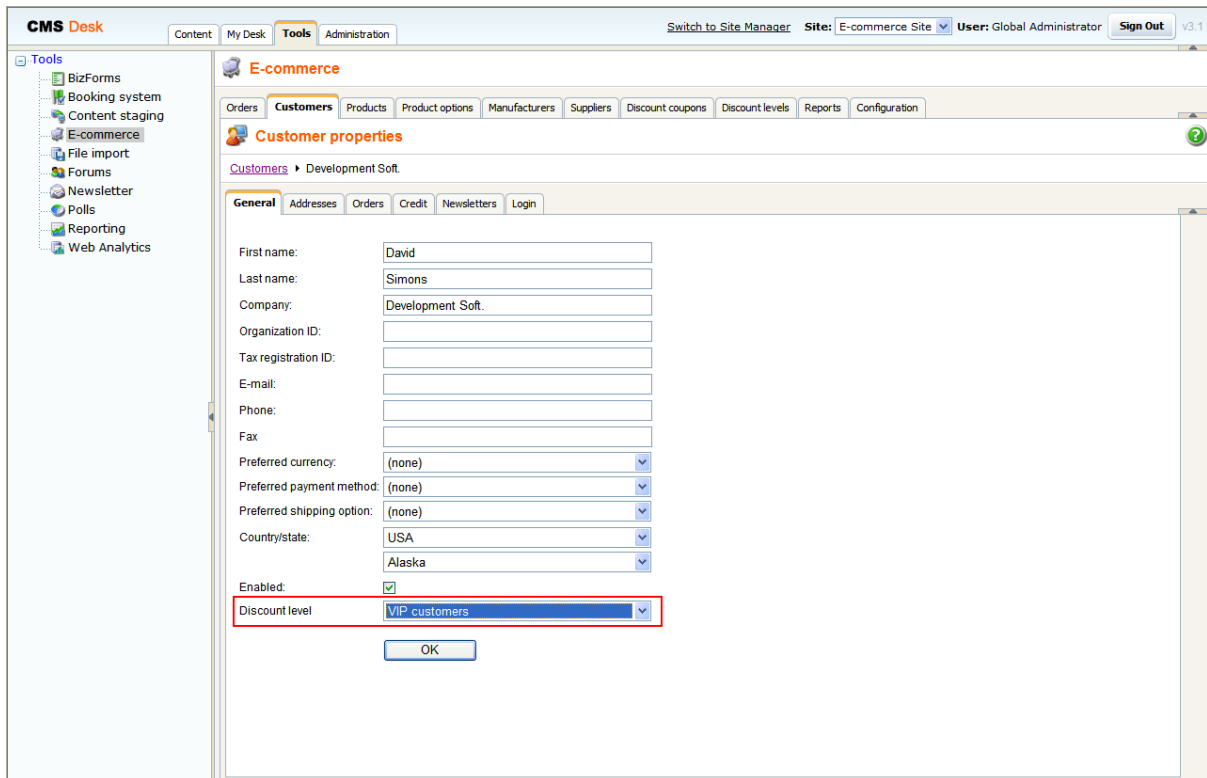

Before making a purchase, a user has to sign in to her account so that the assigned discount level is automatically take into account while calculating the unit and total price.

Step 1 of 6 - Add some products to the shopping cart



Shopping cart

Currency: U.S. Dollar

Remove	Product name	Units	Unit price	Unit discount	Tax	Subtotal
<input type="checkbox"/>	Apple MacBook Air	<input type="text" value="5"/>	2094.00	209.40	0.00	9423.00

If you have a coupon code, please enter it here:



Total shipping: \$ 0.00
Total price: \$ 9423.00

Volume discounts

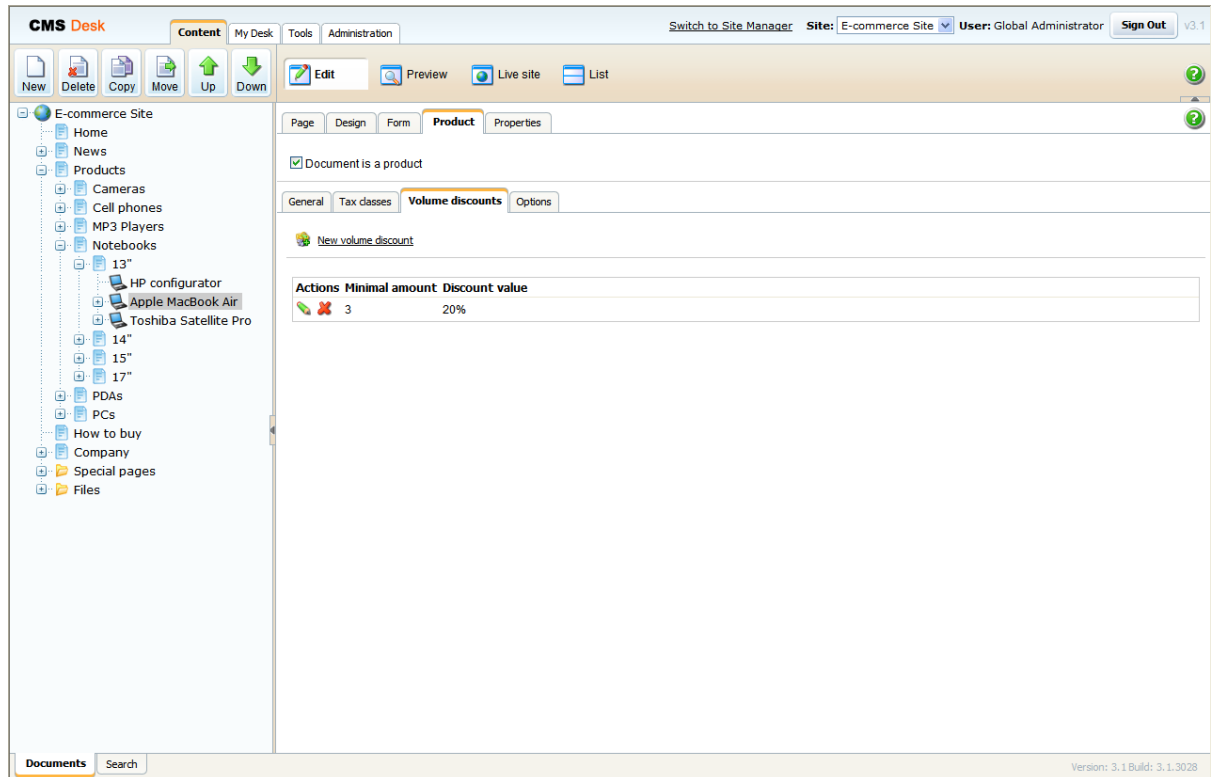
You can define volume discounts at **CMS Desk -> Content -> <choose product> -> Product -> Volume discounts.**



The screenshot displays the CMS Desk interface for configuring volume discounts. The left sidebar shows a tree view of the site structure, including 'E-commerce Site', 'Home', 'News', 'Products', 'Cameras', 'Cell phones', 'MP3 Players', 'Notebooks', '13"', 'HP configurator', 'Apple MacBook Air', 'Toshiba Satellite Pro', '14"', '15"', '17"', 'PDAs', 'PCs', 'How to buy', 'Company', 'Special pages', and 'Files'. The main content area is titled 'Product' and includes a 'Volume discounts' tab. A checkbox labeled 'Document is a product' is checked. Below this, there is a 'New volume discount' button and a table with the following data:

Actions	Minimal amount	Discount value
  	3	20%

The interface also shows a 'Documents' search bar at the bottom left and a version number 'Version: 3.1 Build: 3.1.3028' at the bottom right.

On condition a user adds to the **shopping cart** sufficient amount of units of the product with the assigned volume discount, the given discount level is automatically taken into account and its subtracted from the unit price.

Step 1 of 6 - Add some products to the shopping cart



Shopping cart

Currency: U.S. Dollar

Remove	Product name	Units	Unit price	Unit discount	Tax	Subtotal
<input type="checkbox"/>	Apple MacBook Air	<input type="text" value="5"/>	2094.00	418.80	0.00	8376.00

If you have a coupon code, please enter it here:

Total shipping: \$ 0.00
Total price: \$ 8376.00

You can combine all the discount types. While combining the discount coupon and the discount level, though, only higher discount applies.

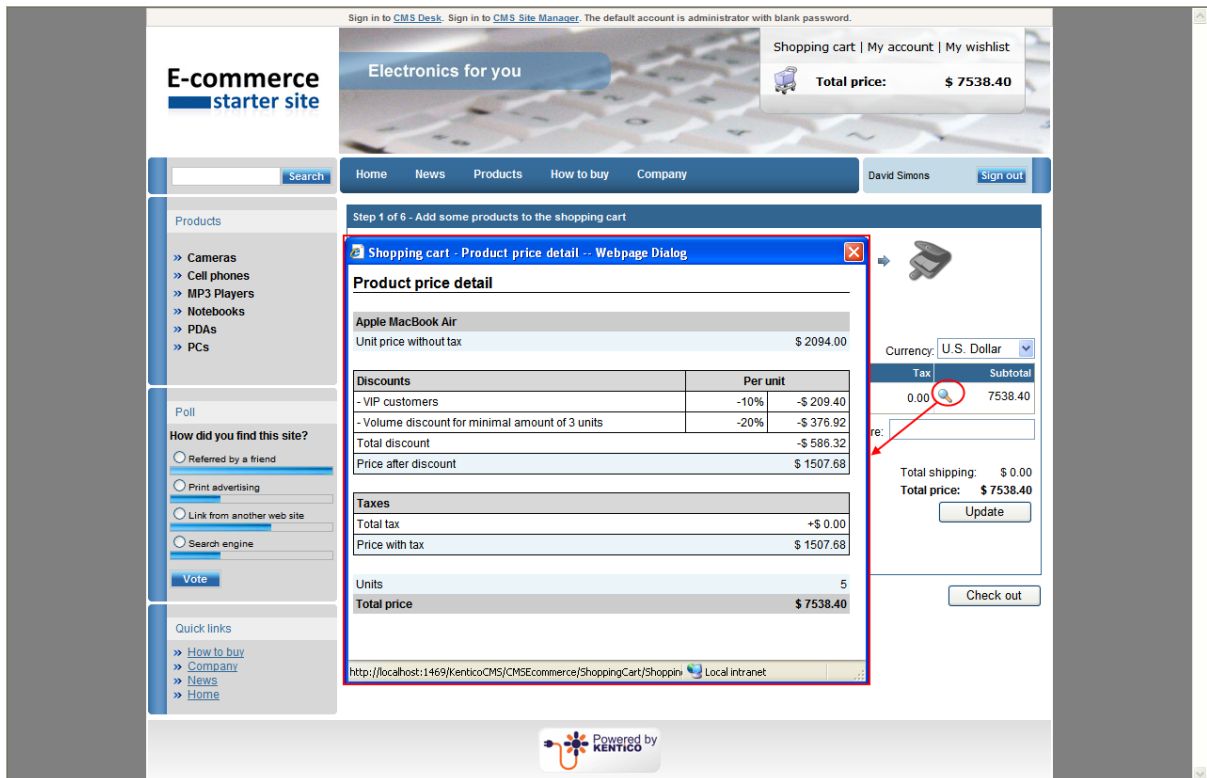

For more details about how are discounts calculated see [Figure B: Discount calculation](#).

6.23 Deleting old shopping carts

The deletion of old shopping carts can be done automatically with the pre-defined task.

By default, all the shopping carts older than 30 days are considered old and therefore are erased when running the **Deleting old shopping carts** task. You can change the period of time after which the shopping cart expires by modifying the **CMSShoppingCartExpirationPeriod** key in the **web.config** file. See the [Web.config settings](#) chapter for more details.

This task erase not only old shopping carts, but anonymous customers with no order as well. This anonymous customer with no order appears when an anonymous user adds an item into the shopping cart. She is then required to enter her name and e-mail and she becomes a customer. If this anonymous user for whatever reason doesn't get through all steps of the checkout process, she remains in the system as an anonymous customer with no order.

You can schedule the deletion of old shopping carts task by setting the **Scheduler** at **CMS Site Manager -> Administration -> Scheduled tasks**.

The screenshot shows the 'Task properties' configuration window for the 'Delete old shopping carts' task. The interface includes a navigation menu on the left with 'Administration' expanded to 'Scheduled tasks'. The main area contains the following fields:

- Task display name: Delete old shopping carts
- Task name: Ecommerce.DeleteOldShoppingCarts
- Task assembly name: CMS.Ecommerce
- Task class name: CMS.Ecommerce.ShoppingCartCleaner
- Period: Day
- Start time: 1/30/2007 11:50:00 (with a 'Now' button)
- Every: 1 Day
- Task interval: Days (Monday, Tuesday, Wednesday, Thursday, Friday, Saturday, Sunday) - all are checked.
- Task data: (empty text area)
- Task enabled:
- Delete task after last run:
- Server name: (empty text field)

An 'OK' button is located at the bottom of the configuration area.

For more information please refer to the **Scheduler** chapter in **Kentico CMS Developer's guide**.

Part

VII

Purchase process and payment gateways

7 Purchase process and payment gateways

7.1 Purchase process overview

The standard purchase (checkout) process looks like this:

1. The user browses the web site and adds the products to the **shopping cart**. She can modify the number of items in the cart. She can also insert a discount coupon.
2. The user clicks the **Checkout** button. She can choose from three options:
 - **Sign in using an existing account** - if she already has a user account
 - **Create a new account**
 - **Continue as anonymous customer** - this option doesn't require the user to create a user account, but she needs to enter her details with every purchase. You can enable/disable this option at **CMS Desk -> Tools -> E-commerce -> Configuration -> Store Settings -> Allow anonymous customers**.
3. The user enters/updates customer data, including first name, last name, e-mail and company name.
4. The customer enters billing/shipping address or chooses from the list of previously used addresses. The user can also choose to enter an additional company headquarters address that can be enabled at **CMS Desk -> Tools -> E-commerce -> Configuration -> Store Settings -> Use an extra company address**.
5. The user chooses the payment and shipping method.
6. The user previews the order.
7. The user completes the order or continues with on-line payment. The order status is set to **New**. The order notification e-mail is sent to store owner and to the customer if it's configured in **CMS Desk -> Tools -> E-commerce -> Configuration -> Store Settings** dialog.
8. The payment is processed by the payment gateway. If the payment succeeds/fails, the order status is set to values specified at **CMS Desk -> Tools -> E-commerce -> Configuration -> Payment methods -> <select some payment method> -> Order status when payment succeeds/fails**. A payment notification e-mail is sent to store owner and to the customer if it's configured in **CMS Desk -> Tools -> E-commerce -> Configuration -> Store Settings** dialog and if the payment is successfully completed.
9. The user is redirected to the page configured in the properties of the **Shopping cart** web part, in the **Default URL after purchase** value.

Shopping cart content

The shopping cart content is stored in the database and it's bound to the current user name. If the user is anonymous, the cart ID is stored in a browser cookie. It ensures that the cart content is preserved even if the session is lost during application restart. You can find more details on how the shopping cart is retrieved in [Figure D - Shopping cart retrieval](#).

When the checkout process is completed (regardless if the payment succeeds or fails), a new order is created and the shopping cart content is moved to the order. The cart is empty then.

The cart content is accessible in your code using the **ShoppingCartInfoObj** class in the checkout process steps.

7.2 Customizing the purchase process

The purchase process can be enhanced with your custom steps or you can remove some steps. This can be done at **CMS Desk -> Tools -> E-commerce -> Configuration -> Store settings -> Checkout process**.

For each step, you can specify the following values:

Caption	The step caption in the checkout process.
Code name	The name of the site used in the code.
Image file name	Name of the file used in the checkout process header. The image must be stored in folder ~\App_Themes\<<stylesheet name>\Images\ShoppingCart.
Control path	Virtual path to the ASCX control representing the dialog in the given step. Example: ~/CMSEcommerce/ShoppingCart/ ShoppingCartOrderAddresses.ascx
Show on the live site	Indicates if this step should be used in the checkout process on the live site. (see below)
Show in Customer section	Indicates if this step should be used in the checkout process when creating a new order for the given customer. (see below)
Show in Order section	Indicates if this step should be used in the checkout process for a new order created from the administration interface. (see below)
Show in Order items section	Indicates if this step should be used in the checkout process when editing items of an existing order. (see below)

See chapter [Developing custom dialogs for the checkout process](#) for more details on development of custom steps.

Types of the checkout process

There are four different types of checkout process:

- Checkout process 1 - New order on the live site
- Checkout process 2 - New order from section **CMSDesk -> Tools -> E-commerce -> Customers/ (some customer) -> Orders.**
- Checkout process 3 - New order from section **CMSDesk -> Tools -> E-commerce -> Orders.**
- Checkout process 4 – Editing existing order from section **CMSDesk -> Tools -> E-commerce -> Orders -> (some order) -> Items.**

Below, you can find the screenshots of these types:

Checkout process 1 – New order on the live site

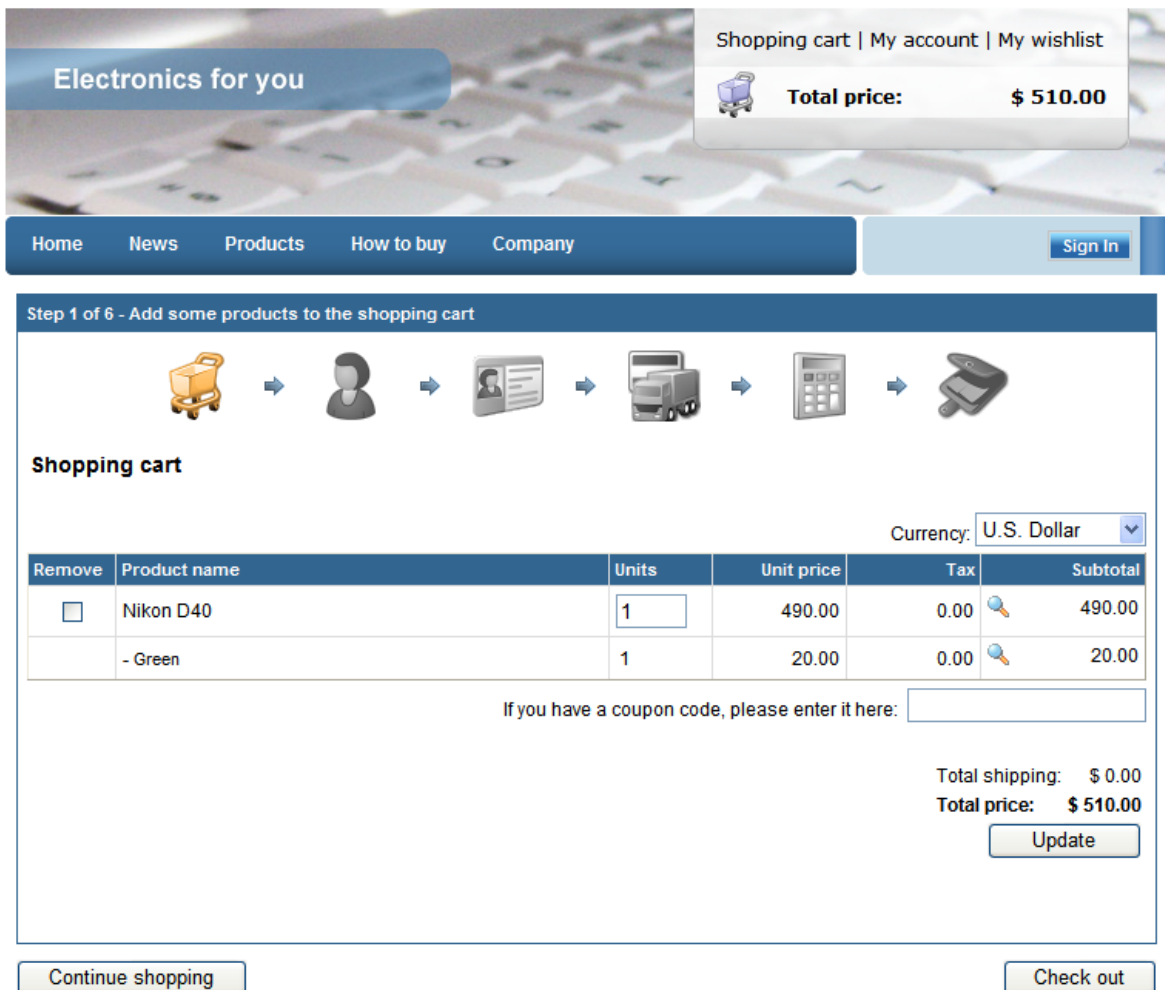







Shopping cart | My account | My wishlist

 **Total price:** **\$ 510.00**



Home News Products How to buy Company [Sign In](#)

Step 1 of 6 - Add some products to the shopping cart

 →  →  →  →  → 

Shopping cart

Currency:

Remove	Product name	Units	Unit price	Tax	Subtotal
<input type="checkbox"/>	Nikon D40	<input type="text" value="1"/>	490.00	0.00 	490.00
	- Green	1	20.00	0.00 	20.00

If you have a coupon code, please enter it here:

Total shipping: \$ 0.00
Total price: \$ 510.00

Checkout process 2 - New order from section CMSDesk -> Tools -> E-commerce -> Customers -> (some customer) -> Orders

E-commerce

Orders **Customers** Products Manufacturers Suppliers Discount coupons Discount levels Reports Configuration

Customer properties

Customers ▶ Customer Kentico

General Addresses **Orders** Credit Login

New order ?

Orders ▶ New order

Step 1 of 5 - Select billing and shipping address

Billing address

Billing address: (new) ▼

Name (company or personal):

Address lines:

City:

ZIP:

Country: USA ▼

Alaska ▼

Phone number:

My shipping address is different from the billing address.

My company address is different from the billing address.

Back Next

Checkout process 3 - New order from section CMSDesk -> Orders

The screenshot shows the 'E-commerce' section of the CMSDesk interface. The navigation menu includes 'Orders', 'Customers', 'Products', 'Manufacturers', 'Suppliers', 'Discount coupons', 'Discount levels', 'Reports', and 'Configuration'. The current page is titled 'New order' and shows a breadcrumb trail 'Orders > New order'. The main content area is titled 'Step 1 of 6 - Select customer' and contains a 'Customer' section with a text input field for 'Customer detail or its part:' and a 'Search' button. Below the input field is a large empty rectangular area. A 'Next' button is located at the bottom right of the main content area.

Checkout process 4 - Editing existing order from section CMSDesk -> Tools -> E-commerce -> Orders -> (some order) -> Items.

The screenshot shows the 'E-commerce' section of the CMSDesk interface. The navigation menu includes 'Orders', 'Customers', 'Products', 'Manufacturers', 'Suppliers', 'Discount coupons', 'Discount levels', 'Reports', and 'Configuration'. The current page is titled 'Orders > 553' and shows a breadcrumb trail 'Orders > 553'. The main content area is titled 'Step 1 of 2 - Add some products to the shopping cart' and contains a 'Shopping cart' section. The 'Items' tab is selected, showing a table with one item: 'HP IPAQ 114'. The table has columns for 'Remove', 'Product name', 'Units', 'Unit price', 'Tax', and 'Subtotal'. The 'Units' column has a value of '1'. The 'Unit price' is '249.00', 'Tax' is '0.00', and 'Subtotal' is '249.00'. Below the table is a text input field for a coupon code. The total shipping is '\$ 8.00' and the total price is '\$ 257.00'. An 'Update' button is located at the bottom right of the main content area.

Remove	Product name	Units	Unit price	Tax	Subtotal
<input type="checkbox"/>	HP IPAQ 114	1	249.00	0.00	249.00 Detail

Total shipping: \$ 8.00
Total price: \$ 257.00

7.3 Developing custom dialogs for the checkout process

Creating a custom checkout process step

1. Create new web user control (*.ascx) and place your own form controls into it.
2. Go to its code behind and set control class to inherit from **CMS.EcommerceProvider.ShoppingCartStep**.
3. There are several methods you can override to reach the required functionality:
 - **IsValid()** – Validates current step custom data and returns validation result. True – all step data is correct and can be processed, False – some step data is not correct or missing and cannot be processed. In this case appropriate error message should be displayed. By default, it returns True.
 - **ProcessStep()** – Processes current step information (updates shopping cart data) and returns result of this action. True – shopping cart data was updated successfully and customer can be moved to the next checkout process step, False – shopping cart update failed and customer cannot be moved to the next step. In this case appropriate error message should be displayed. By default, it returns True.
 - **ButtonBackClickAction()** – Defines action which is run after the Back button is clicked. By default, the parent shopping cart control method ButtonBackClickAction() is called which moves customer one step backward in the checkout process.
 - **ButtonNextClickAction()** – Defines action which is run after the “Next button” is clicked. By default, the parent shopping cart control method ButtonNextClickAction() is called which moves customer one step forward in the checkout process when the current step data is valid and processed successfully.
4. There are several properties you should use to get or set required information:
 - **ShoppingCartControl** – parent shopping cart control the step belongs to
 - **ShoppingCartInfoObj** – shopping cart object which stores all data during the checkout process
 - **CheckoutProcessStep** – checkout process step information
5. The step control is created and can be registered as your custom checkout process step.

If the control represents checkout process steps in different [checkout process types](#) and these steps differ from each other only a little, you can create one control and specify a different behavior depending on the checkout process type as follows:

[C#]

```
using System;
using CMS.EcommerceProvider;
using CMS.GlobalHelper;

switch (this.ShoppingCartControl.CheckoutProcessType)
{
    case CheckoutProcessEnum.LiveSite:
        // Here comes the code which will be run only
        // when it is a checkout process on the live site
        break;

    case CheckoutProcessEnum.CMSDeskOrder:
        // Here comes the code which will be run only
        // when it is a checkout process in the section CMSDesk/Tools/
        E-commerce/Orders
        break;
}
```

```
default:
    // Here comes the code which will be run in all other cases
    break;
}
```

Example 1 - My step

The following example shows a simple checkout process step definition. It displays the total price and an editable field to insert a customer comment. After the **Next** button is clicked, the editable field is checked for emptiness. If it is not empty the customer comment is saved and shopping cart data is updated. Otherwise, an appropriate error message is displayed. If the customer is a member of role "VipCustomers", an extra step with an additional form for VIP customers is loaded (MyVipStep.ascx). The **Back** button action is not overridden.

[MyStep.ascx]

```
<%@ Control Language="C#" AutoEventWireup="true" CodeFile="MyStep.ascx.cs" Inherits="MyStep" %>
<asp:Label ID="lblError" runat="server" EnableViewState="false" Visible="false"></asp:Label>
<table>
  <tr>
    <td><asp:Label ID="lblTotalPrice" runat="server" /></td>
    <td><asp:Label ID="lblTotalPriceValue" runat="server" /></td>
  </tr>
  <tr>
    <td><asp:Label ID="lblComment" runat="server" /></td>
    <td><asp:TextBox ID="txtComment" runat="server" TextMode="MultiLine" Rows="3" /></td>
  </tr>
</table>
```

[MyStep.ascx.cs]

```
using System;
using System.Data;
using System.Configuration;
using System.Collections;
using System.Web;
using System.Web.Security;
using System.Web.UI;
using System.Web.UI.WebControls;
using System.Web.UI.WebControls.WebParts;
using System.Web.UI.HtmlControls;

using CMS.GlobalHelper;
using CMS.Ecommerce;
using CMS.EcommerceProvider;

public partial class MyStep : ShoppingCartStep
{
    protected void Page_Load(object sender, EventArgs e)
    {
        // Initialize labels
        lblTotalPrice.Text = ResHelper.GetString("MyStep.TotalPrice");
        lblComment.Text = ResHelper.GetString("MyStep.Comment");

        // Display rounded and formatted total price
        lblTotalPriceValue.Text =
            CurrencyInfoProvider.GetFormattedPrice(ShoppingCartInfoObj.RoundedTotalPrice,
            ShoppingCartInfoObj.CurrencyInfoObj);

        if (!this.ShoppingCartControl.IsCurrentStepPostBack)
        {
            // Load customer comment
            txtComment.Text = this.ShoppingCartInfoObj.ShoppingCartCustomData["CustomerComment"];
        }
    }
}
```

```
}

/// <summary>
/// Validates current step data.
/// </summary>
/// <returns></returns>
public override bool IsValid()
{
    // Check customer comment for emptiness
    if (txtComment.Text.Trim() == "")
    {
        // Display error message
        lblError.Text = ResHelper.GetString("MyStep.Error.CommentMissing");
        lblError.Visible = true;

        // Data are not correct - customer comment missing
        return false;
    }
    else
    {
        // Data are correct
        return true;
    }
}

/// <summary>
/// Process current step data
/// </summary>
/// <returns></returns>
public override bool ProcessStep()
{
    // Update shopping cart with customer comment
    this.ShoppingCartInfoObj.ShoppingCartCustomData["CustomerComment"] =
    txtComment.Text.Trim();

    try
    {
        // Update shopping cart in database
        ShoppingCartInfoProvider.SetShoppingCartInfo(this.ShoppingCartInfoObj);

        // Current step data were processed and saved successfully
        return true;
    }
    catch
    {
        // Display error message
        lblError.Text = ResHelper.GetString("MyStep.Error.ShoppingCartUpdate");
        lblError.Visible = true;

        // Current step data update failed
        return false;
    }
}

/// <summary>
/// Action after the "Next button" is clicked
/// </summary>
public override void ButtonNextClickAction()
{
    // If customer is registered and is a member of role "VipCustomers"
```

```

        if ((this.ShoppingCartInfoObj.UserInfoObj != null)
            && (this.ShoppingCartInfoObj.UserInfoObj.IsInRole("VipCustomers",
this.ShoppingCartInfoObj.SiteName)))
        {
            if (IsValid() && ProcessStep())
            {
                try
                {
                    // Load extra step for VIP customers which is not included
                    // in standard checkout process definition
                    ShoppingCartStep ctrl =
(ShoppingCartStep)this.Page.LoadControl("~/CMSEcommerce/ShoppingCart/MyVipStep.ascx");
                    this.ShoppingCartControl.LoadStep(ctrl);

                    // Note: Current step index is not increased
                }
                catch
                {
                    // Error while loading extra step control -> Do standard action
                    base.ButtonNextClickAction();
                }
            }
        }
        else
        {
            // Do standard action (validate step data, process step data, load next step)
            base.ButtonNextClickAction();
        }
    }
}

```

My VIP step

This is an external checkout process step which is not included in standard checkout process definition. It is loaded only when the current customer is a member of role "VipCustomers", however, you will need to use your own condition for loading your external steps. There is no data validation (Vip customer comment can be empty). Neither "Back button action" nor "Next button action" is overridden so it means the standard methods are called after the **Back** button and **Next** button are clicked.

[MyVipStep.ascx]

```

<%@ Control Language="C#" AutoEventWireup="true" CodeFile="MyVipStep.ascx.cs" Inherits="MyVipStep" %>
<asp:Label ID="lblError" runat="server" EnableViewState="false" Visible="false"></asp:Label>
<asp:Label ID="lblComment" runat="server" />
<asp:TextBox ID="txtComment" runat="server" TextMode="MultiLine" Rows="3" />

```

[MyVipStep.ascx.cs]

```

using System;
using System.Data;
using System.Configuration;
using System.Collections;
using System.Web;
using System.Web.Security;

```

```

using System.Web.UI;
using System.Web.UI.WebControls;
using System.Web.UI.WebControls.WebParts;
using System.Web.UI.HtmlControls;

using CMS.GlobalHelper;
using CMS.Ecommerce;
using CMS.EcommerceProvider;

public partial class CMSEcommerce_TestVipCustomers : ShoppingCartStep
{
    protected void Page_Load(object sender, EventArgs e)
    {
        // Initialize label
        lblComment.Text = ResHelper.GetString("MyVipStep.Comment");

        if (!this.ShoppingCartControl.IsCurrentStepPostBack)
        {
            // Load VIP customer extra comment
            txtComment.Text =
Convert.ToString(this.ShoppingCartInfoObj.ShoppingCartCustomData["VipComment"]);
        }

    }

    /// <summary>
    /// Process current step data
    /// </summary>
    /// <returns></returns>
    public override bool ProcessStep()
    {
        // Update shopping cart with VIP customer extra comment
        this.ShoppingCartInfoObj.ShoppingCartCustomData["VipComment"] = txtComment.Text.Trim();

        try
        {
            // Update shopping cart in database
            ShoppingCartInfoProvider.SetShoppingCartInfo(this.ShoppingCartInfoObj);

            // Current step data were processed and saved successfully
            return true;
        }
        catch
        {
            // Display error message
            lblError.Text = ResHelper.GetString("MyStep.Error.ShoppingCartUpdate");
            lblError.Visible = true;

            // Current step data update failed
            return false;
        }
    }
}

```



Important notes on step order

Notice that data of all steps (including Kentico CMS standard shopping cart steps) are always processed by themselves, not by the parent shopping cart control. It means if you reorder standard checkout process steps you can experience a strange behavior

because of missing information or omitting some important action.

For example if you move step "Order preview" in the standard checkout process definition for the live site before steps "Select billing and shipping address" and "Select payment and shipping methods" some order preview data will be missing (billing and shipping addresses, payment method and shipping option) because they were not entered yet. But even worse is that entered data of the following two steps ("Select billing and shipping address", "Select payment and shipping methods") will not be saved.

This happens because the order is saved after the "Next button" of the step "Order preview" is clicked and these two steps include completely different actions after their "Next buttons" are clicked.

7.4 Payment gateways

Once the customer enters appropriate information, you can redirect her to an on-line payment gateway. You can choose from the following options:

- **No on-line payment** - the customer is only displayed with some "Thank you" page.
- **Customer credit** - the customer can pay using her credit. The credit must be entered in the customer details by the store owner. This option is useful for customer loyalty programs. For further information please refer to the [Customer credit](#) chapter.
- **Authorize.NET** - the customer pays using her card. See [Authorize.NET configuration](#) for more details.
- **PayPal** - the customer pays using her card or PayPal account. See [PayPal configuration](#) for more details.
- **Custom payment gateway** - you can integrate some other payment gateway using your code. See [Developing custom payment gateways](#) for more details.

7.5 Authorize.NET configuration

Authorize.NET is one of the most popular gateway providers. It uses plain HTTPS POST operations against its gateway server.

What do I need?

1. **Kentico CMS 3.0 or higher** with built in Authorize.NET support.
2. **Internet Merchant Account** - A type of bank account that allows a business to accept internet credit card payments (the card is not physically presented to the merchant).
3. **Payment Gateway Account** - A secure internet bridge between your web site and the credit card processing networks.

See **Authorize.NET Getting Started Guide** at <http://www.authorize.net/files/ecommerceguide.pdf> for more details.

How does it work?

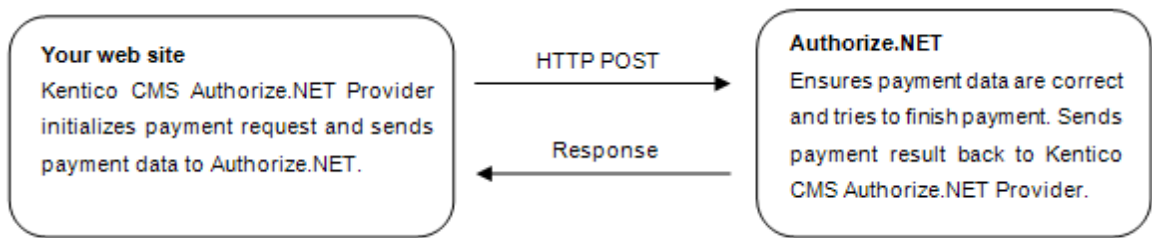

Authorize.NET settings in Kentico CMS 3.1 or higher

Before you can offer customers to use Authorize.NET payment gateway you will need to do some necessary settings:

1. Go to the section *CMSSiteManager -> Settings -> Payment Gateways – Authorize.NET*
2. Enter **API Login** (API Login ID for the payment gateway account) and **Transaction key** (Transaction key obtained from the Merchant Interface) to identify your payments.
3. Turn off **Test Mode** of the Authorize.NET payment gateway. Gateway behavior depends on both test mode settings: in CMSSiteManager and in Authorize.NET Merchant Interface. See table below for more details about test mode settings:

Kentico CMS	Merchant Interface	Transaction processed as
ON	ON	test transaction
OFF	ON	test transaction
ON	OFF	test transaction
OFF	OFF	live transaction

4. Ensure that Authorize.NET payment method is registered and enabled.
5. Check Authorize.NET payment method payment gateway settings:
 - Payment gateway url: *https://secure.authorize.net/gateway/transact.dll*
 - Payment gateway assembly name: *CMS.EcommerceProvider*
 - Payment gateway class name: *CMS.EcommerceProvider.CMSAuthorizeNetProvider*

Please note: If you want your transaction to be processed as a test transaction turn on the Test Mode and use *https://test.authorize.net/gateway/transact.dll* as your payment gateway url.

While using the Authorize.NET payment method, a customer is required to fill her credit card information in the last step of the checkout process to finish payment. After the payment is finished the order payment result is updated.

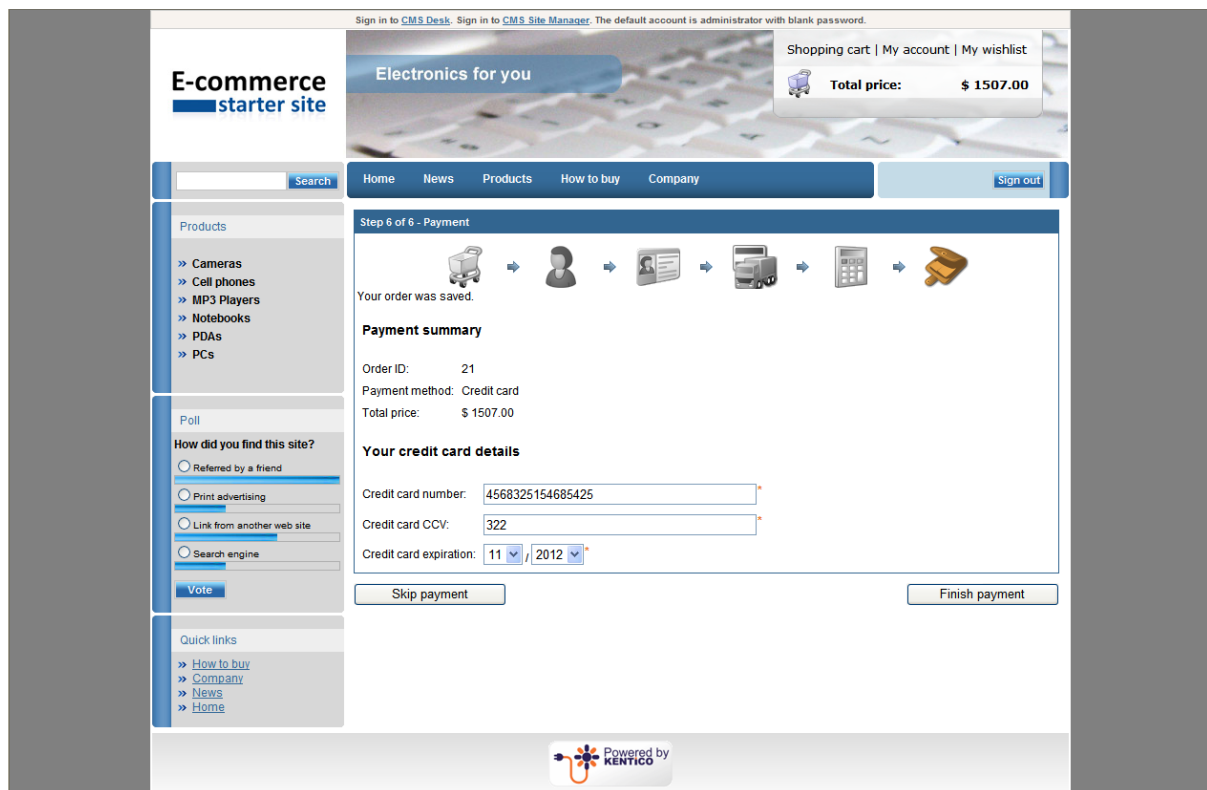

7.6 PayPal configuration

What do I need?

1. **Kentico CMS 3.0 or higher** with built in PayPal support.
2. **PayPal account**, see https://www.paypal.com/us/cgi-bin/webscr?cmd=_registration-run for more details.

PayPal settings in Kentico CMS 3.1 or higher

Before you can offer customers to use PayPal payment gateway you will need to do some necessary settings:

1. Go to the section *CMSSiteManager -> Settings -> Payment Gateways – PayPal*
2. Enter **Business** (E-mail address for merchant's PayPal account) to identify your payments. Other settings are optional:
 - **Notify Url**: The URL to which PayPal posts information about the transaction, see *PayPal IPN* for more details. If set overrides settings in PayPal merchant's interface.
 - **Cancel Return Url**: The URL to which the buyer's browser is redirected if payment is cancelled; for example, a URL on your website that displays a "Payment Canceled" page. Browser is redirected to a PayPal web page by default.
 - **Return Url**: The URL to which the buyer's browser is redirected after completing the payment; for example, a URL on your site that displays a "Thank you for your payment" page. Buyer is redirected to a PayPal web page by default.
3. Ensure that PayPal payment method is registered and enabled.
4. Check PayPal payment method payment gateway settings:

- Payment gateway url: *https://www.paypal.com/cgi-bin/webscr*
- Payment gateway assembly name: *CMS.EcommerceProvider*
- Payment gateway class name: *CMS.EcommerceProvider.CMSPayPalProvider*

Please note:

- If you want your transaction to be processed as test transaction use *https://www.sandbox.paypal.com/cgi-bin/webscr* as your payment gateway url and sign up for PayPal SandBox testing environment, see https://www.paypal.com/IntegrationCenter/ic_sandbox.html for more details.
- The price is always rounded to two decimal places, otherwise the PayPal payment gateway wouldn't allow the payment.

How does it work?

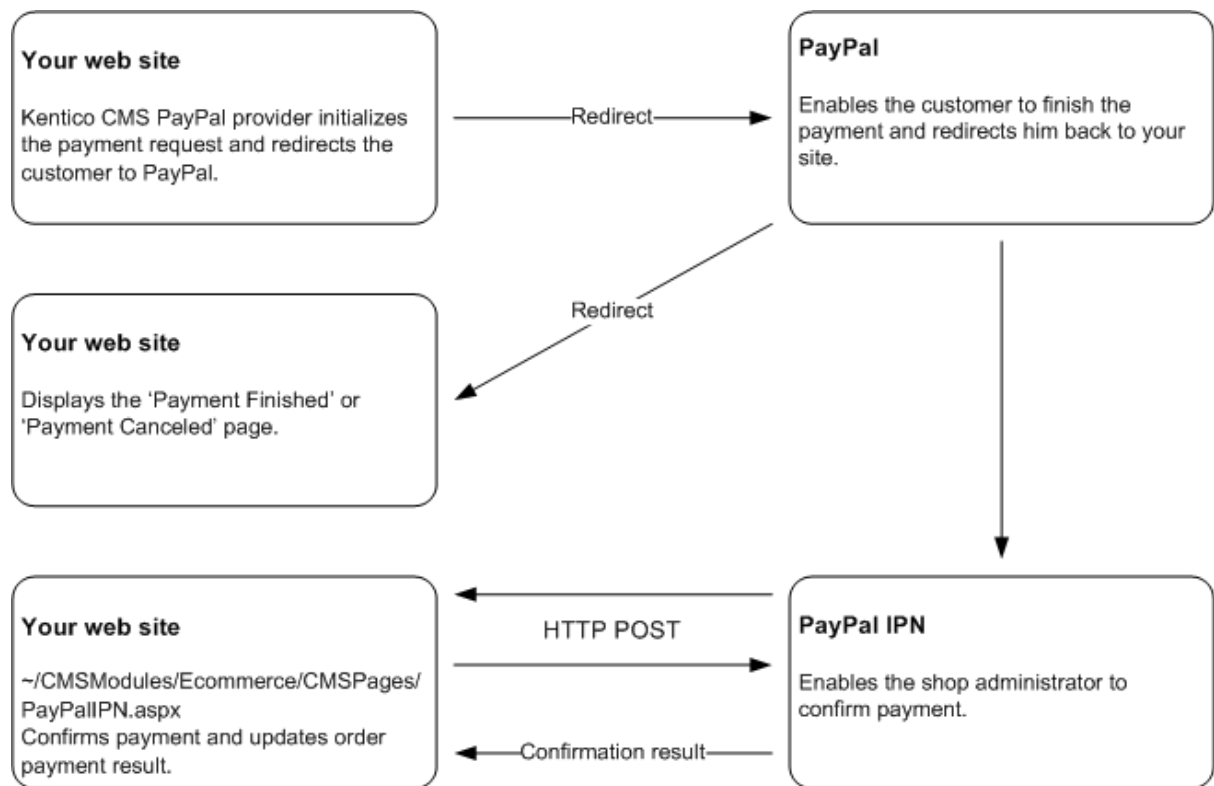

IPN - Instant Payment Notification

It's easy to spoof the return URL you sent to PayPal since it's visible on the query string. Therefore a user could simply type the Confirmation Url in directly and you should not confirm the order at this point. You can manually check for orders on the PayPal site or wait for PayPal's confirmation e-mails etc. all of which let you know for sure that the order was processed in a 'manual' way.

To automate this process, PayPal can optionally ping you back at another URL with order completion information. It uses a mechanism called Instant Payment Notification (IPN) which is essentially a web based callback mechanism that calls a pre-configured url on your site. IPN must be enabled on the PayPal site and when enabled IPN sends a confirmation to you at this url after the order was processed. PayPal then expects a return from you within a certain timeframe (a few minutes) and return a response to you to confirm you that the customer has paid. To do this you have to POST the data back to PayPal by echoing back all the form data that PayPal sends to you. IPN is optional, but it's a requirement if you need to confirm your orders immediately with your customers.

While using the PayPal payment method, a customer is not required to fill any additional information in the last step of the checkout process. After the "Finish payment" button is clicked she is redirected to the PayPal payment gateway to finish payment:

The screenshot displays the checkout process on an e-commerce site. At the top, there's a navigation bar with 'Home', 'News', 'Products', 'How to buy', and 'Company'. A search bar is also present. The main content area is titled 'Step 6 of 6 - Payment'. It shows a progress bar with icons for shopping cart, user profile, address, product, payment, and shipping. Below this, a 'Payment summary' section lists: Order ID: 25, Payment method: PayPal, and Total price: \$ 125.00. A 'PayPal' section contains the instruction: 'Click 'Finish payment' button to redirect to PayPal payment gateway.' At the bottom of this section are two buttons: 'Skip payment' and 'Finish payment'. The site footer includes the text 'Powered by KENTICO'.

7.7 Developing custom payment gateways

Creating a custom payment gateway

Here's a general overview of the process of integrating a custom payment gateway:

1. Create a payment gateway form with your custom controls to enable customers to enter their payment data such as credit card number, see section [Creating custom payment gateway form](#).
2. Create your custom payment gateway class and override required methods for payment processing, see section [Creating custom payment gateway class](#).
3. Go to the **CMSDesk -> Tools -> E-commerce -> Configuration -> Payment methods**.
4. Create a new payment method and register your custom payment gateway as described in the [Payment methods](#) chapter.

Creating a custom payment gateway form

1. Create a new web user control (*.ascx) and place it into your site folder which is located in the root of your web project.

Since the control is located in the site folder it is included in export package of your site.

2. Set control class to inherit from abstract class *CMS.EcommerceProvider*.
CMSPaymentGatewayForm
3. There are several methods you need to override to reach your required functionality:
 - **LoadData()** – Initializes form controls with customer payment data.
 - **ValidateData()** – Validates customer payment data.
 - **ProcessData()** – Process customer payment data and saves them to the *ShoppingCartInfo* object.
4. There are several properties to get or set required information:
 - **ShoppingCartControl** – Parent shopping cart control the current shopping cart step belongs to.
 - **ShoppingCartInfoObj** – Shopping cart object which stores all data during the checkout process.

Please note: Payment data, such as credit card numbers, credit card codes and others are not saved into the database because of security reasons.

Creating custom payment gateway class

1. Create a new library (assembly) as a part of your solution and a new class inside this library.
2. Add a reference to *System.Web* assembly into the project with the payment gateway (Right-click the References folder, choose Add reference, select .NET -> System.Web).
3. Set your class to inherit from abstract class *CMS.EcommerceProvider*.
CMSPaymentGatewayProvider.
4. There are several methods you can override to reach your required functionality:
 - **AddCustomData()** – Adds payment gateway custom controls to the current shopping cart step. By default *CMSPaymentGatewayForm* control is added to the payment data container and its data are loaded.
 - **RemoveCustomData()** – Removes payment gateway custom controls from the current shopping cart step. By default all controls from payment data container are removed.
 - **ValidateCustomData()** - Validates payment gateway custom data of the current shopping cart step. By default *CMSPaymentGatewayForm* control data are validated.
 - **ProcessCustomData()** - Process payment gateway custom data of the current shopping cart step. By default *CMSPaymentGatewayForm* data are processed.
 - **ProcessPayment()** - Process payment - you need to override this method to process payment by your payment processor.

- **GetPaymentDataForm()** – Loads payment gateway form with custom controls – you need to override this method to get your own payment gateway form.
5. There are several properties to get or set required information:
- **ShoppingCartControl** – Parent shopping cart control the current shopping cart step belongs to.
 - **ShoppingCartInfoObj** – Shopping cart object which stores all data during the checkout process .If *OrderId* is set it is created from existing order, otherwise it is returned from current shopping cart control.
 - **OrderId** – Order ID. Set this value when you want to process payment for the existing order outside the checkout process.
 - **PaymentDataContainer** – Payment gateway custom controls container of the current shopping cart step control.
 - **PaymentResult** – Payment result (see caption *Payment Result*)
 - **IsPaymentCompleted** – Indicates whether order payment was already completed. It is determined by order payment result.
 - **InfoMessage** - Payment result message displayed to user when payment succeeds.
 - **ErrorMessage** - Payment result message displayed to user when payment fails.
6. Compile the library.
7. Ensure the library file (*.dll) is included in <your web project folder>/Bin directory.

Example

The following example shows a custom payment processor implementation. It allows customers to pay for their orders using some external payment gateway similar to PayPal, let's call it Custom Gateway. Customer is asked for her credit card number in the last step of checkout process. Credit card number is validated for emptiness and processed after the "Finish payment" button is clicked. If it succeeds payment process is performed – required payment data are attached to the payment url and customer is redirected to Custom Gateway. If payment process fails (payment gateway url is not defined) order payment result is updated and appropriate error message is displayed. Notice that order is saved before the customer is asked to pay for it, it happens immediately after the "Order now" button is clicked.

Please note:

- It is not secure to send credit card information as a part of payment gateway url. Customer is usually asked for her credit card number after she is redirected to the payment gateway itself; otherwise another way of sending credit card information should be used instead.
- For more details about how payment gateway could inform merchant about the result of the payment which was finished outside her web site see caption PayPal (IPN – Instant Payment Notification).

 **E-commerce**

Orders Customers Products Manufacturers Suppliers Discount coupons Discount levels Reports **Configuration**

Store settings
Departments
Shipping options
Payment methods
Tax classes
Currencies
Exchange rates
Order status
Public status
Internal status
Invoice

 **New payment method**

[Payment method](#) ▶ New payment method

Payment method display name:

Payment method code name:

Enabled:

Payment gateway settings

Payment gateway URL :

Payment gateway assembly name:

Payment gateway class name:

Order status when payment succeeds:

Order status when payment fails:

Example of custom payment gateway definition.

Custom payment gateway form

It is a simple form with one input field to enter customer credit card number, see image below.

Step 6 of 6 - Payment

Your order was saved.

Payment summary

Order ID: 604
Payment method: Custom gateway
Total price: \$ 460.00

Your credit card details

Credit card number:

CustomGatewayForm.ascx

Skip payment Finish payment

CustomGatewayForm.ascx

```
<%@ Control Language="C#" AutoEventWireup="true" CodeFile="CustomGatewayForm.ascx.cs"
Inherits="CMSEcommerce_Example_CustomGatewayForm" %>
<asp:Label ID="lblTitle" runat="server" EnableViewState="false" CssClass="BlockTitle" />
<asp:Label ID="lblError" runat="server" EnableViewState="false" CssClass="ErrorLabel" Visible="false" />
<asp:Label ID="lblCardNumber" EnableViewState="false" runat="server" />
<asp:TextBox ID="txtCardNumber" runat="server" />
```

CustomGatewayForm.ascx.cs

[C#]

```
using System;
using System.Data;
using System.Configuration;
using System.Collections;
using System.Web;
using System.Web.Security;
using System.Web.UI;
using System.Web.UI.WebControls;
using System.Web.UI.WebControls.WebParts;
using System.Web.UI.HtmlControls;

using CMS.EcommerceProvider;
using CMS.GlobalHelper;

public partial class CMSEcommerce_Example_CustomGatewayForm : CMSPaymentGatewayForm
{
    protected void Page_Load(object sender, EventArgs e)
    {
        // Initialize label
        lblTitle.Text = "Your credit card details";
        lblCardNumber.Text = "Credit card number:";
    }
}
```

```

    /// <summary>
    /// Initializes form controls with customer payment data.
    /// </summary>
    public override void LoadData()
    {
        // Display customer credit card number
        txtCardNumber.Text = ValidationHelper.GetString(this.ShoppingCartInfoObj.PaymentGatewayCustomData[
"CustomGatewayCardNumber"], "");
    }

    /// <summary>
    /// Validates customer payment data.
    /// </summary>
    /// <returns></returns>
    public override string ValidateData()
    {
        if (txtCardNumber.Text.Trim() == "")
        {
            lblError.Visible = true;
            lblError.Text = "Please enter your credit card number";
            return lblError.Text;
        }
        return "";
    }

    /// <summary>
    /// Process customer payment data.
    /// </summary>
    /// <returns></returns>
    public override string ProcessData()
    {
        // Save credit card number
        this.ShoppingCartInfoObj.PaymentGatewayCustomData["CustomGatewayCardNumber"] = txtCardNumber.Text.Trim();
        return "";
    }
}

```

Custom payment gateway class

The following example uses assembly name *CMS.CustomProvider* and class *CMS.CustomProvider*. *CustomGateway*, however, you will need to use your own names.

CustomGateway.cs

[C#]

```

using System;
using System.Collections.Generic;
using System.Text;
using System.Web;
using System.Collections;

using CMS.EcommerceProvider;
using CMS.GlobalHelper;

namespace CMS.CustomProvider
{

```

```
/// <summary>
/// Class representing Custom Gateway processor.
/// </summary>
public class CustomGateway : CMSPaymentGatewayProvider
{
    /// <summary>
    /// Returns payment gateway form with custom controls.
    /// </summary>
    /// <returns></returns>
    public override CMSPaymentGatewayForm GetPaymentDataForm()
    {
        try
        {
            return (CMSPaymentGatewayForm)this.ShoppingCartControl.LoadControl("~/CMSEcommerce/Example/
CustomGatewayForm.ascx");
        }
        catch
        {
            return null;
        }
    }

    /// <summary>
    /// Process payment.
    /// </summary>
    public override void ProcessPayment()
    {
        // Get payment gateway url
        string url = this.GetPaymentGatewayUrl();

        if (url != "")
        {
            // Initialize payment parameters
            Hashtable parameters = InitializePaymentParameters();

            // Add required payment data to the url
            url = GetFullPaymentGatewayUrl(url, parameters);

            // Redirect to payment gateway to finish payment
            this.ShoppingCartControl.Page.Response.Redirect(url);
        }
        else
        {
            // Show error message - payment gateway url not found
            this.ErrorMessage = "Unable to finish payment: Payment gateway url not found.";

            // Update payment result
            this.PaymentResult.PaymentDescription = this.ErrorMessage;
            this.PaymentResult.PaymentIsCompleted = false;

            // Update order payment result in database
            this.UpdateOrderPaymentResult();
        }
    }

    /// <summary>
    /// Returns table with initialized payment parameters.
    /// </summary>
    /// <returns></returns>
    private Hashtable InitializePaymentParameters()
    {
        Hashtable parameters = new Hashtable();
    }
}
```

```
parameters["orderid"] = this.ShoppingCartInfoObj.OrderId;
parameters["price"] = this.ShoppingCartInfoObj.TotalPrice;
parameters["currency"] = this.ShoppingCartInfoObj.CurrencyInfoObj.CurrencyCode;
parameters["cardnumber"] = Convert.ToString(this.ShoppingCartInfoObj.PaymentGatewayCustomData[
"CustomGatewayCardNumber"]);

    return parameters;
}

/// <summary>
/// Returns payment gateway url with payment data in query string.
/// </summary>
/// <param name="url">Payment gateway url.</param>
/// <param name="parameters">Initialized payment paremeters.</param>
/// <returns></returns>
private string GetFullPaymentGatewayUrl(string url, Hashtable parameters)
{
    foreach (DictionaryEntry parameter in parameters)
    {
        // Add payment data to the url
        url = UrlHelper.AddParameterToUrl(url, Convert.ToString(parameter.Key), HttpUtility.UrlEncode(
Convert.ToString(parameter.Value)));
    }
    return url;
}
}
```

7.8 Payment results

Payment Results

Payment result is stored in xml format which is represented by the object *CMS.Ecommerce.PaymentResultInfo*. Each payment result xml node is equal to the single payment result item which is represented by the object *CMS.Ecommerce.PaymentResultItemInfo*.

Base payment result items are:

- **Payment date** – Date and time when the payment result was last updated.
- **Payment method** – Payment method which was used for payment.
- **Payment is completed** – Yes/No. Indicates whether payment was already completed.
- **Payment status** – Completed/Failed/(your custom status). Status of the payment.
- **Payment transaction ID** – Completed payment unique identifier generated by the payment gateway.
- **Payment description** – Describes payment result in more details.

Payment result item properties are:

- **Name**: Unique identifier of the item.
- **Header**: Friendly name of the item visible to user (simple text or localizable string).
- **Text**: Outer representation of the item value visible to user (simple text or localizable string).
- **Value**: Inner representation of the item value used by developers.

Following example shows xml definition of the order payment result extended by the item “*authorizationcode*” used by the Authorize.NET:

```
<result>
  <item name="date" header="{PaymentGateway.Result.Date}" value="1/27/2008 5:01:41 PM" />
  <item name="method" header="{PaymentGateway.Result.PaymentMethod}" text="Credit card" value="230" />
  <item name="completed" header="{PaymentGateway.Result.IsCompleted}" value="1" text="{PaymentGateway.Result.PaymentCompleted}" />
  <item name="status" header="{PaymentGateway.Result.Status}" text="{PaymentGateway.Result.Status.Completed}" value="completed" />
  <item name="transactionid" header="{PaymentGateway.Result.TransactionID}" value="0" />
  <item name="description" header="{PaymentGateway.Result.Description}" />
  <item name="authorizationcode" header="{AuthorizeNet.AuthorizationCode}" value="000000" />
</result>
```

The following example shows order payment result which is visible to the user in CMSDesk:

Date: 1/27/2008 5:01:41 PM
Method: Credit card
Is completed: YES
Status: Completed
Transaction ID: 0
Authorization code: 000000

Please note:

- o The order payment result remains empty until it is updated by the payment gateway processor.
- o You don't need to specify both item value and item text if they are identical because payment result rendering method can manage this and renders payment result as follows: try to render item text, if not found, try to render item value.

How to customize payment result

You can use *PaymentResultInfo* properties to get or set specified item text or value:

- PaymentDate
- PaymentMethodID
- PaymentMethodName
- PaymentIsCompleted
- PaymentStatusName
- PaymentStatusCode
- PaymentTransactionID

You will need to use public methods **GetPaymentResultItemInfo**(*string itemName*) and **SetPaymentResultItemInfo**(*PaymentResultItemInfo itemObj*) to get and set your custom payment result items.

The following example shows how to get and set custom payment result item while payment processing by your custom payment gateway provider:

[C#]

```
using CMS.Ecommerce;

// Set authorization code
PaymentResultItemInfo item = new PaymentResultItemInfo();
item.Header = "{$AuthorizeNet.AuthorizationCode$}";
item.Name = "authorizationcode";
item.Value = "00000";
this.PaymentResult.SetPaymentResultItemInfo(item);
```

[C#]

```
using CMS.Ecommerce;

// Get authorization code
PaymentResultItemInfo item = this.PaymentResult.GetPaymentResultItemInfo(
"authorizationcode");
```

7.9 Customer credit

Customers may receive a credit on their account. They can then purchase products using this credit. This feature is useful for customer loyalty competitions where customers receive bonus points/credit for their previous purchases and can order some products once they achieve an appropriate amount of credit.

Please note: the purchase can be made only using one payment method, so it's not possible to combine credit payment with another form of payment and the whole order must be paid using the credit.

The customer receives credit when the store owner adds some credit event to the customer history. This can be done in **Customer properties** dialog, on the **Credit** tab.

Before you can offer registered customers to use the **Customer credit** you will need to do some necessary settings:

1. Ensure that the **Customer credit** payment method is registered and enabled.
2. Check the **Customer credit** payment method settings:
 - Payment gateway url: leave blank
 - Payment gateway assembly name: *CMS.EcommerceProvider*
 - Payment gateway class name: *CMS.EcommerceProvider.CMSCreditPaymentProvider*

While using the customer credit, a customer is not required to fill any additional information in the last step of the checkout process. After the "Finish payment" button is clicked her credit is decreased by specified amount which is equal to the order total price in default currency and the order payment result is updated.

The screenshot displays the checkout process for an e-commerce site. The page title is "E-commerce starter site" and the main navigation includes "Home", "News", "Products", "How to buy", and "Company". The user is logged in as "david simons". The current step is "Step 6 of 6 - Payment". A progress bar shows the checkout steps: Shopping cart, User profile, Address, Payment method, Order summary, and Confirmation. The "Payment summary" section shows: Order ID: 2, Payment method: Customer credit, Total price: \$ 770.00. The "Use credit for payment" section shows: Available credit: \$ 1000.00. There are two buttons: "Skip payment" and "Finish payment". The footer includes the Kentico logo and "Powered by KENTICO".

Part



VIII

Developing custom providers

8 Developing custom providers

8.1 Overview

The E-commerce module allows you to override the default behavior and calculations by using custom providers that ensure various operations.

How does it work?

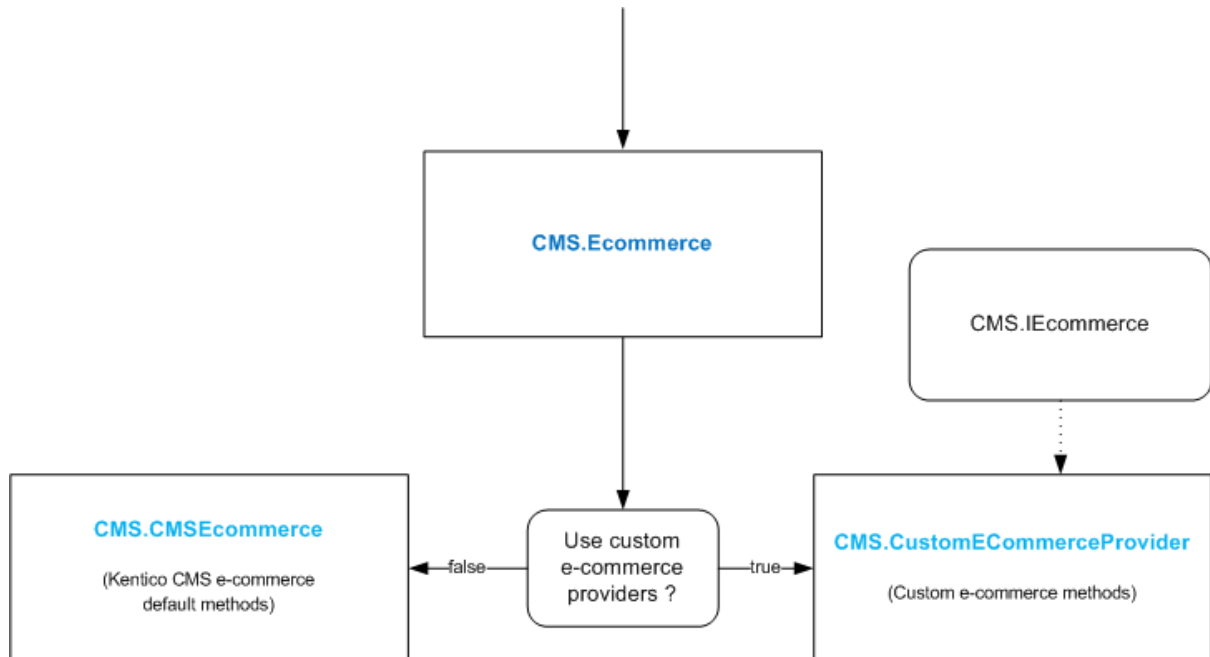

For more information please refer to the [Using custom providers](#) chapter.

The following example shows the way of customizing the calculation of the shipping cost by modifying the **CMS.CustomECommerceProvider.CustomShippingOptionInfoProvider.CalculateShipping** method. Similarly, you can modify any method of any class from the **CMS.**

CustomECommerceProvider library. All the methods that can be customized call by default the equivalent methods from the **CMS.CMSEcommerce** namespace. This ensures the standard behaviour in the case the given method is not modified and the using custom e-commerce provider is enabled at the same time.

1. The default code of the **CMS.CustomECommerceProvider.CustomShippingOptionInfoProvider.CalculateShipping** method.

```

public double CalculateShipping(object cartObj, string siteName)
{
    return CMS.CMSEcommerce.ShippingOptionInfoProvider.CalculateShipping((CMS.Ecommerce.ShoppingCartInfo)
cartObj, siteName);
}
  
```

2. The customized code of the **CMS.CustomECommerceProvider.CustomShippingOptionInfoProvider.CalculateShipping** method

```
using CMS.Ecommerce;
using CMS.SettingsProvider;
using CMS.SiteProvider;

public double CalculateShipping(object cartObj, string siteName)
{
    CMS.Ecommerce.ShoppingCartInfo cart = cartObj as CMS.Ecommerce.ShoppingCartInfo;
    if (cart != null)
    {
        if ((cart.UserInfoObj != null) && (cart.UserInfoObj.IsInRole("VIPCustomers", siteName)))
        {
            // Free shipping for VIP customers
            return 0;
        }
        else
        {
            // Get shipping address details
            CMS.Ecommerce.AddressInfo address = CMS.Ecommerce.AddressInfoProvider.GetAddressInfo(cart.ShoppingCartShippingAddressID);
            if (address != null)
            {
                // Get shipping address country
                CountryInfo country = CountryInfoProvider.GetCountryInfo(address.AddressCountryID);
                if ((country != null) && (country.CountryName.ToLower() != "usa"))
                {
                    // Add an extra charge to standard shipping price for non-usa customers
                    double extraCharge = SettingsKeyProvider.GetDoubleValue("ShippingExtraCharge");
                    return CMS.CMSEcommerce.ShippingOptionInfoProvider.CalculateShipping(cart, siteName) +
                        extraCharge;
                }
            }
        }
    }

    // Get standard shipping price in other cases
    return CMS.CMSEcommerce.ShippingOptionInfoProvider.CalculateShipping(cart, siteName);
}
```

8.2 Using custom providers

By default, Kentico CMS is delivered with sample custom providers with samples of method implementation. To include custom providers within your web project, please follow these steps:

1. Open your web project in Visual Studio.
2. Copy the C:\Program Files\Kentico CMS\<version>\CodeSamples\CustomECommerceProvider directory to your working directory and add the project **CustomECommerceProvider.csproj** to your solution.
3. Remove all the references to the Kentico CMS libraries from the **CustomECommerceProvider** project and replace them with references to the corresponding DLL references from your web project / bin directory.
4. Delete the **CMS.CustomECommerceProvider.dll** file from the /bin directory of the CMS project.
5. Add the project reference to the CustomECommerceProvider project to your web project
6. Compile the solution.

Now your project is ready to use the custom providers. To enable custom providers, add following

settings key to you web.config file:

```
<appSettings>
  <add key="CMSUseCustomEcommerceProviders" value="true" />
</appSettings>
```

Since now, your web application will call your custom providers to handle the E-commerce requests. If you do not want to override the behaviour of certain methods, you should just call the CMS provider method to perform the original action. Original CMS providers are located in the **CMS.CMSEcommerce** namespace. See the next chapters to get the information about the providers and actions that they should perform in your methods to ensure the system consistency.

Every custom provider must implement a corresponding interface from the **CMS.IECommerce** namespace. For example: the **CustomSKUInfoProvider** implements the **ISKUInfoProvider** interface.

All providers use **System.Object** parameter types, so you need to type the method parameters to appropriate data types.

Please note: If you implement only some of the custom providers, you should ensure that your data are consistent with the other E-commerce database data. In case of inconsistency the system might not work well.

Additional information

If you need additional information on some class or database table structure, please see the **Database Reference** or **API Reference** documentation.

8.3 CustomAddressInfoProvider

This provider works with customer addresses and provides the address data manipulation in general. The methods work with **CMS.Ecommerce.AddressInfo** class which is replaced by object in the method headers. The provider implements the following methods:

- **object GetAddressInfo(int addressId)** – returns the AddressInfo object by address ID.
- **object GetAddressInfo(string addressName)** – returns the AddressInfo object address name.
- **void SetAddressInfo(object address)** – inserts/updates the AddressInfo object to the database. If the AddressID property value is set, the database record is updated, if not, the record is inserted and new record ID must be set in the object.
- **void DeleteAddressInfo(int addressId)** – deletes the address record from the database by given address ID.
- **string GetAddressName(object addressInfoObj)** – generates the address name.
- **DataSet GetAddresses(string where, string orderBy)** - returns the DataSet of all the addresses filtered by WHERE condition and ordered by orderBy expression, see the database reference for the address

column definition.

- `DataSet GetAddressesForCustomer(int customerId, bool showBilling, bool showShipping, bool showCompany, bool onlyEnabled)` - returns the `DataSet` of all the addresses for the specified user according to the input parameters, see the database reference for the currency column definition.
- `bool CheckDependencies(int addressId)` - returns true if some objects depend on the address specified by its ID.

8.4 CustomCurrencyInfoProvider

This class provides the methods to work with currencies. Methods work with **CMS.Ecommerce.CurrencyInfo** class.

- `object GetCurrencyInfo(int currencyId)` – returns the `CurrencyInfo` object by currency ID.
- `object GetCurrencyInfo(string currencyName)` – returns the `CurrencyInfo` object by code name.
- `void SetCurrencyInfo(object currency)` – inserts/updates the currency record to the database. If `CurrencyID` is set, it performs an update, else it performs a new currency insertion and initializes new record ID.
- `void DeleteCurrencyInfo(int currencyId)` – deletes the currency record specified by its ID.
- `DataSet GetAllCurrencies()` – returns the `DataSet` of all the currencies, see the database reference for the currency column definition.
- `DataSet GetCurrencies(string where, string orderBy)` – returns the `DataSet` of all the currencies filtered by where condition and ordered by orderBy expression, see the database reference for the currency column definition.
- `DataSet GetCurrenciesWithExchangeRate()` – returns the `DataSet` with currencies, that have a currently valid an exchange rate specified.
- `object GetMainCurrency()` – returns the main (default) currency. The main currency has the `CurrencyIsMain` value set to true, all the others must have it set to false.
- `void RemoveMainCurrency()` – removes the main currency flag from the currency records (it sets all `CurrencyIsMain` values to false)
- `double RoundTo(double price, int currencyId)` – performs the price rounding based on the currency defined by its ID.
- `double RoundTo(double price, object ciObj)` – performs the price rounding based

on the given CurrencyInfo object.

- `string GetFormattedPrice(double price, object ciObj)` – returns the price string formatted by given CurrencyInfo object content (CurrencyFormatString).
- `string GetFormattedValue(double price, object ciObj)` – returns the string formatted by given CurrencyInfo object (to display the value without price, in grids etc.).
- `double GetLastValidExchangeRate(int currencyId)` – returns the last valid exchange rate for given currency ID.
- `double GetCurrentValidExchangeRate(int currencyId)` – returns the currently valid exchange rate for given currency ID.
- `double GetExchangeRate(int currencyId, DateTime time)` – returns exchange rate for given currency ID at given time.
- `bool CheckDependencies(int currencyId)` – returns true if some objects depend on the currency specified by its ID.
- `void RecalculateValues(double rate, bool updExchangeRates, bool updSKUs, bool updTaxes, bool updDiscountCoupons, bool updVolumeDiscounts, bool updCredit, bool updShippingOptions, bool updDocuments, bool updFreeShipping)` - recalculates specified values with given exchange rate.

8.5 CustomCustomerInfoProvider

This class works with customer information. It uses the **CMS.Ecommerce.CustomerInfo** class.

- `object GetCustomerInfo(int customerId)` – returns the CustomerInfo object by customer ID.
- `object GetCustomerInfoByUserId(int userId)` – returns the CustomerInfo object for the registered user with specified user ID. Please note that registered customers are connected to corresponding CMS_User records. This couple ensures proper authentication and shopping cart privacy. Anonymous customers do not have their corresponding CMS_User record and are strictly used for one-time orders.
- `object GetCustomerInfo(Guid customerGuid)` – Returns the CustomerInfo object selected by customer GUID.
- `void SetCustomerInfo(object customer)` – updates or inserts the customer database record using given CustomerInfo object data. If CustomerID is set, update is performed, else new record is inserted.
- `void DeleteCustomerInfo(int customerId)` – deletes the customer record specified by its customer ID.

- `bool CheckDependencies(int customerId)` – returns true if some objects depend on the record with given customer ID.
- `DataSet GetCustomers()` – returns the DataSet with all customers. Please see the database reference for columns and their types.
- `DataSet GetCustomers(string where, string orderBy)` – returns the DataSet of all customers selected with given WHERE condition and ORDER BY clause.
- `DataSet GetCustomersList()` – returns the DataSet with customers joined with their Country and State data, see `View_COM_Customer_Joined` view for the required result columns.
- `DataSet GetCustomersList(string where, string orderBy)` – returns the customer list as a DataSet selected by given WHERE condition and ORDER BY specification.

8.6 CustomDepartmentInfoProvider

Department provider works with the department records and definition that can be used to separate the product groups and branches. It uses the `CMS.Ecommerce.DepartmentInfo` class.

- `object GetDepartmentInfo(int departmentId)` – returns the DepartmentInfo object by given department ID.
- `object GetDepartmentInfo(string departmentName)` – returns the DepartmentInfo object selected by given department code name.
- `void SetDepartmentInfo(object department)` – updates the department record with the data from given DepartmentInfo object. If DepartmentID value is set, it updates the existing record, else it inserts a new record.
- `void DeleteDepartmentInfo(int departmentId)` – deletes department record specified by its department ID.
- `void AddUserToDepartment(int departmentId, int userId)` – adds the user to the department. User-Department is N:N relationship. This assignment is defined for the administration purposes and access control.
- `void RemoveUserFromDepartment(int departmentId, int userId)` – removes user from the department.
- `bool IsUserInDepartment(int departmentId, int userId)` – returns true if the user is member of given department.
- `DataSet GetUserDepartments(int userId)` – returns the DataSet of the user departments, see the database reference for required column definition.
- `DataSet GetDepartments()` – returns DataSet of all departments defined in the E-

commerce system.

- `DataSet GetDepartments(string where, string orderBy)` – returns DataSet of the departments selected with given condition and order by specification.
- `bool CheckDependencies(int departmentId)` – returns true if some objects depend on given department to prevent the deletion.
-

8.7 CustomDiscountCouponInfoProvider

This class works with discount coupon information. It uses the `CMS.Ecommerce.DiscountCouponInfo` class.

- `object GetDiscountCouponInfo(int discountCouponId)` – returns DiscountCouponInfo object selected by given discount coupon ID.
- `object GetDiscountCouponInfo(string discountCouponCode)` – returns the DiscountCouponInfo object selected by given coupon code.
- `void SetDiscountCouponInfo(object discountCoupon)` – updates the discount coupon record with the data from given DiscountCouponInfo object. If DiscountCouponID is set, it updates the record, else it inserts a new record and initializes its ID.
- `void DeleteDiscountCouponInfo(int discountCouponId)` – deletes specified coupon record by given ID.
- `bool CheckDependencies(int discountCouponId)` – returns true if there are some objects dependent on the given coupon.
- `DataSet GetCouponProducts(int couponId)` – returns the DataSet products assigned to the discount coupon. There is an N:N relationship between products (SKUs) and coupons.
- `DataSet GetCouponProducts(int couponId, string where, string orderBy)` – returns the DataSet of coupon products selected with given condition and order.
- `void AddSKUToDiscountCoupon(int skuId, int discountId)` – adds the relationship between product and coupon.
- `void RemoveSKUToDiscountCoupon(int skuId, int discountId)` - removes the relationship between product and coupon.
- `bool IsSKUAssignedToDiscountCoupon(int skuId, int discountId)` – returns true if product is assigned to the discount coupon.
- `bool IsSKURelatedToDiscountCoupon(int skuId, int discountId)` - returns true if there is a relation between specified discount coupon and SKU.
- `DataSet GetDiscountCoupons()` – returns the DataSet of all discount coupons. See

database reference for required fields.

- `DataSet GetDiscountCoupons(string where, string orderBy)` – returns the coupons with specified condition and order applied.

8.8 CustomDiscountLevelInfoProvider

This class works with discount level information. It uses the `CMS.Ecommerce.DiscountLevelInfo` class.

- `void DeleteDiscountLevelInfo(int discountLevelId)` – deletes the given discount level.
- `object GetDiscountLevelInfo(int discountLevelId)`, `object GetDiscountLevelInfo(discountLevelCodeName)` - returns the `DiscountLevelInfo` for the specified discount level.
- `void SetDiscountLevelInfo(object discountLevel)` - updates discount level.
- `object GetAllDiscountLevelInfo()` - get all discount levels
- `object GetAllDiscountLevelInfo(string where, string orderBy)` - get all discount levels filtered by where condition and ordered by orderBy expression.
- `void AddToDepartment(int discountLevelId, int departmentId)` - assigns specified discount level to the department. It means that discount is applied only to products from the specified departments then.
- `void RemoveFromDepartment(int discountLevelId, int departmentId)` - removes specified discount level from the department.
- `DataSet GetDepartments(int discountLevelId)` - returns `DataSet` of all the departments to which the specified discount level is applied.

8.9 CustomExchangeTableInfoProvider

This class works with exchange rates. It uses the `CMS.Ecommerce.ExchangeTableInfo` class.

- `object GetExchangeTableInfo(int exchangeTableId)` – returns the `ExchangeTableInfo` object selected by given table ID.
- `object GetExchangeTableInfo(string tableName)` - returns the `ExchangeTableInfo` object selected by given table name.
- `void SetExchangeTableInfo(object exchangeTable)` – updates the exchange table

record based on given ExchangeTableInfo object data. If ExchangeTableID is set, updates the record, else inserts a new one.

- `void DeleteExchangeTableInfo(int exchangeTableId)` – deletes the exchange table.
- `DataSet GetRatesByTableID(int tableId)` – returns the DataSet of exchange rates for given table ID.
- `void DeleteRateByRateId(int currencyId, int tableId)` – deletes specified currency exchange rate from exchange table.
- `void SetRateByRateId(int rateId, int CurrencyId, double rateValue, int tableId)` – sets the specified rate value.
- `object GetLastValidExchangeTableInfo()` – returns ExchangeTableInfo object that was last valid.
- `double ApplyExchangeRate(double value, double exchangeRate)` – applies the exchange rate to the given price. By default $\text{resulting_price} = \text{original_price} / \text{exchange_rate}$.
- `DataSet GetExchangeTables()` – returns the DataSet of all the exchange tables. See database reference for column details.
- `DataSet GetExchangeTables(string where, string orderBy)` – returns the DataSet of exchange tables selected with given condition and order.

8.10 CustomInternalStatusInfoProvider

This class manages the internal status lookup table. It uses the **InternalStatusInfo** class.

- `object GetInternalStatusInfo(int internalStatusId)` – returns the InternalStatusInfo object selected by its ID.
- `object GetInternalStatusInfo(string internalStatusName)` – returns the InternalStatusInfo object selected by its name.
- `void SetInternalStatusInfo(object internalStatus)` – updates status record with data from given InternalStatusInfo object. If StatusID is set, updates the record, if not inserts a new record.
- `void DeleteInternalStatusInfo(int internalStatusId)` – deletes the internal status record with given ID.
- `bool CheckDependencies(int internalStatusId)` – returns true if some records depend on the status record.
- `DataSet GetStatuses(object status)` – returns the DataSet of all the statuses. See

Database Reference for column definition.

- `object GetInternalStatusInfos(string where, string orderBy)` - returns the `DataSet` of all the statuses filtered by where condition and ordered by orderBy expression.

8.11 CustomManufacturerInfoProvider

This class manages the manufacturer lookup table. It uses the **ManufacturerInfo** class.

- `object GetManufacturerInfo(int manufacturerId)` – returns the `ManufacturerInfo` object selected by given ID
- `object GetManufacturerInfo(string manufacturerName)` – returns the `ManufacturerInfo` object selected by given name.
- `void SetManufacturerInfo(object manufacturer)` – updates/inserts the manufacturer record with data from given `ManufacturerInfo` object. If `ManufacturerID` is set, updates the record, if not inserts the record.
- `void DeleteManufacturerInfo(int manufacturerId)` – deletes the specified manufacturer record.
- `bool CheckDependencies(int manufacturerId)` – returns true if some objects depend on given manufacturer record.
- `DataSet GetAllManufacturers(object status)` – returns the `DataSet` of all the manufacturers. See database reference for column details.
- `object GetManufacturerInfos(string where, string orderBy)` – returns the `DataSet` of all the manufacturers filtered by where condition and ordered by orderBy expression.

8.12 CustomOptionCategoryInfoProvider

This class works with product option category information. It uses the **CMS.Ecommerce.OptionCategoryInfo** class.

- `object GetOptionCategoryInfo(int optionCategoryId)` – returns the `OptionCategoryInfo` object selected by given ID.
- `void SetOptionCategoryInfo(object manufacturer)` – updates/inserts the product option category record with data from given **OptionCategoryInfo** object. If `CategoryID` is set, updates the record, if not inserts the record.
- `void DeleteOptionCategoryInfo(int optionCategoryId)` – deletes the specified option category record.

- `bool CheckDependencies(int categoryId)` – returns true if some objects depend on given product option category record.
- `DataSet GetOptionCategories()` – returns the DataSet of all the product option categories. See database reference for column details.
- `DataSet GetOptionCategories(string where, string orderBy)` – returns the DataSet of all the product option categories filtered by where condition and ordered by orderBy expression.
- `DataSet GetSKUOptionCategories(int skuId, string where)` – returns the DataSet of all the option categories which are assigned to the specified SKU filtered by specified where condition.
- `void AddOptionCategoryToSKU(int categoryId, int skuld)` – assigns option category to the specified SKU.
- `void RemoveOptionCategoryFromSKU(int categoryId, int skuld)` – removes option category from the specified SKU.
- `void SortProductOptionsAlphabetically(int categoryId)`– sorts product options of the specified option category alphabetically (A-Z).

8.13 CustomOrderInfoProvider

This class manages the orders. It uses the OrderInfo class.

- `object GetOrderInfo(int orderId)` – returns the OrderInfo object selected by order ID.
- `void SetOrderInfo(object order)` – updates/inserts the order record based on the given OrderInfo object. If OrderID is set, updates the record, else inserts a new one.
- `void DeleteOrderInfo(int orderId)` – deletes the specified order record.
- `DataSet GetOrders()` – returns the DataSet with the orders. See Database Reference for column details.
- `DataSet GetOrders(string where, string orderBy)` – returns the DataSet of column orders with given condition and order.
- `DataSet GetOrderList()` – returns the DataSet of the orders data joined with their customer, status and currency data.
- `DataSet GetOrderList(string where, string orderBy)` – returns the order list DataSet with given condition and order.
- `string GetInvoice(int orderId, int siteId)` – returns the HTML code of an order invoice.
- `string GetPaymentOption(int paymentId)` – returns the HTML code for the payment

option.

- `string GetShippingOption(int shippingId)` – returns the HTML code for the shipping option.
- `string GetAddress(int addressId)` – returns the HTML code for the given address.
- `string GetInvoiceNumber(object order)` – returns HTML code for the invoice number.
- `string GetOrderDate(object order)` – returns the HTML code for the order date.
- `string GetOrderNote(object order)` – returns the HTML code for the order note
- `string GetTaxRegistrationID(object customerObj)` – returns HTML code for the customer tax registration ID
- `string GetOrganizationID(object customerObj)` – returns HTML code for the customer organization ID
- `string GetTotalShipping(double value, object currency)` – returns the HTML code for the total shipping
- `string GetTotalPrice(double value, object currency)` – returns the HTML code for the total price
- `string GetProductList(DataTable dt, object currency, bool renderDiscount)` – returns the HTML code for the product list (by default simple table of order items).
- `string GetTaxRecapitulation(DataTable dt, object currency)` – returns the HTML code for the tax recapitulation (by default table of the tax summary).
- `void SendOrderNotificationToCustomer(object cartObj)` – sends the order e-mail notification to the customer.
- `void SendOrderNotificationToAdministrator(object cartObj)` – sends the order e-mail notification to the administrator.
- `void SendOrderPaymentNotificationToCustomer(object cartObj)` – sends the order payment e-mail notification to the customer.
- `void SendOrderPaymentNotificationToAdministrator(object cartObj)` – sends the order payment e-mail notification to the administrator.
- `public void SendOrderStatusNotificationToAdministrator(object cartObj)` – sends the e-mail notification to administrator about new order status of the specified order.
- `public void SendOrderStatusNotificationToCustomer(object cartObj)` – sends the e-mail notification to customer about new order status of the specified order.

8.14 CustomOrderItemInfoProvider

This class manages the order items. It uses the **OrderItemInfo** class.

- `object GetOrderItemInfo(int orderItemId)` – returns the **OrderItemInfo** object selected by given ID.
- `void SetOrderItemInfo(object orderItem)` – updates/inserts the order item with given **OrderItemInfo** object data. If `ItemID` is set, updates the existing data, else inserts a new record.
- `void DeleteAllOrderItems(int orderId)` – deletes all items for specified order.
- `void DeleteOrderItemInfo(int orderItemId)` – deletes the order item with given ID.
- `DataSet GetOrderItems(string where, string orderBy)` – returns the **DataSet** of all the order items filtered by where condition and ordered by `orderBy` expression, see the database reference for the order item column definition.

8.15 CustomOrderStatusInfoProvider

Provider contains methods for order status lookup table. It uses the **OrderStatusInfo** class.

- `object GetOrderStatusInfo(int orderStatusId)` – returns the **OrderStatusInfo** object selected by given ID.
- `object GetOrderStatusInfo(string orderStatusName)` – returns the **OrderStatusInfo** object selected by given name.
- `DataSet GetStatuses(object status)` – returns the **DataSet** of order statuses with specified status. See database reference for column definitions.
- `DataSet GetStatuses(string where, string orderBy)` – returns the **DataSet** of all the order statuses filtered by where condition and ordered by `orderBy` expression, see the database reference for the order status column definition.
- `void SetOrderStatusInfo(object orderStatus)` – updates/inserts the order status record with data from given **OrderStatusInfo** object. If `StatusID` is set, updates, else inserts a new record.
- `void DeleteOrderStatusInfo(int orderStatusId)` – deletes the specified order status.
- `void MoveStatusUp(int statusId)` – moves the status up (changes the status order).
- `void MoveStatusDown(int statusId)` – moves the status down (changes the status order).

order).

- `int GetLastStatusOrder()` – returns the order ID of the last status.
- `object GetFirstEnabledStatus()` – returns the first enabled `OrderStatusInfo` object.
- `object GetNextEnabledStatus(int statusId)` – returns next enabled `OrderStatusInfo` object which is situated after the specified status in order status flow
- `object GetPreviousEnabledStatus(int statusId)` – returns previous enabled `OrderStatusInfo` object which is situated before the specified status in order status flow.
- `bool CheckDependencies(int orderStatusId)` – returns true if some objects depend on the status.

8.16 CustomOrderStatusUserInfoProvider

The provider contains methods for order auditing log. It uses the `OrderStatusUserInfo` class.

- `object GetOrderStatusUserInfo(int orderStatusUserId)` – returns the `OrderStatusUserInfo` object selected by given ID.
- `void SetOrderStatusUserInfo(object orderStatusUser)` – updates/inserts the order status history record with data from given `OrderStatusUserInfo` object. Updates when `OrderStatusUserID` is set, else inserts new record.
- `void DeleteOrderStatusUserInfo(int orderStatusUserId)` – deletes specified order status history record.
- `DataSet GetOrderStatusList(int orderId)` – returns the `DataSet` with order status history list, see `View_CMS_OrderStatusUser_Joined` for required columns.

8.17 CustomPaymentOptionInfoProvider

This class manages the payment option lookup table. It uses the `PaymentOptionInfo` class.

- `object GetPaymentOptionInfo(int paymentOptionId)` – returns the `PaymentOptionInfo` object with specified ID.
- `object GetPaymentOptionInfo(string paymentOptionName, string siteName)` – returns `PaymentOptionInfo` object with specified name on given site.
- `void SetPaymentOptionInfo(object paymentOption)` – updates/inserts the payment option record with data from given `PaymentOptionInfo` object. If `PaymentOptionID` is set, updates, else insert a new record.

- `void DeletePaymentOptionInfo(int paymentOptionId)` – deletes the payment option info record.
- `DataSet GetPaymentOptions()` – returns the DataSet of payment options. See database reference for detailed column information.
- `DataSet GetPaymentOptions(string where, string orderBy)` – returns the DataSet of payment options with condition and order.
- `DataSet GetAllPaymentsForSite(int siteId, object status)` – returns all payment options for given site with specified status.
- `bool CheckDependencies(int paymentOptionId)` – returns true if some objects depend on given payment option.
- `string GetPaymentURL(object cartObj)` – returns the payment gateway URL to use with given ShoppingCartInfo object.
- `void AddPaymentToShipping(paymentId, shippingId)` - adds payment method to the given shipping option.
- `DataSet GetShippingPaymentList(int shippingID)` - fills dataset with payment methods for specific shippingID; contains all details.
- `DataSet GetShippingPayments(int shippingOptionId, bool enabled, bool disabled)` - fills dataset with payment methods for specific shippingID; contains only payment method details.
- `void RemovePaymentFromShipping(int paymentId, int shippingId)` - removes payment method from the given shipping option.

8.18 CustomPublicStatusInfoProvider

This class manages the product status lookup table. Methods work with **PublicStatusInfo** class objects, replaced by **object** in method headers. Provider implements following methods:

- `object GetPublicStatusInfo(int publicStatusId)` – returns the PublicStatusInfo object with given ID.
- `object GetPublicStatusInfo(string publicStatusName)` – returns the PublicStatusInfo object with given name.
- `void SetPublicStatusInfo(object publicStatus)` – updates/inserts the public status record with data from given PublicStatusInfo object. If StatusID is set, updates, else inserts a new record.
- `void DeletePublicStatusInfo(int publicStatusId)` – deletes specified public status record.

- `DataSet GetStatuses(object status)` – returns the `DataSet` of all the public statuses with given status.
- `object GetPublicStatusInfos(string where, string orderBy)` – returns the `DataSet` of all the public statuses filtered by where condition and ordered by orderBy expression.
- `bool CheckDependencies(int publicStatusId)` – returns true if some objects depend on given status.

See database reference for the public status column definition or **PublicStatusInfo** class definition for the **PublicStatusInfo** object details.

8.19 CustomShippingOptionInfoProvider

This class manages the shipping option lookup table. It uses the **ShippingOptionInfo** class.

- `object GetShippingOptionInfo(int shippingOptionId)` – returns `ShippingOptionInfo` object with given ID.
- `object GetShippingOptionInfo(string shippingOptionName, string siteName)` – returns `ShippingOptionInfo` object with given name on the given site.
- `void SetShippingOptionInfo(object shippingOption)` – updates/inserts the shipping option with data from given `ShippingOptionInfo` object.
- `void DeleteShippingOptionInfo(int shippingOptionId)` – deletes the specified shipping option.
- `bool CheckDependencies(int shippingOptionID)` – returns true if some objects depend on given shipping option.
- `DataSet GetShippingOptions()` – returns the `DataSet` of all shipping options. See database reference for detailed column information.
- `DataSet GetShippingOptions(string where, string orderBy)` – returns `DataSet` of the shipping options with specified condition and order.
- `DataSet GetAllShippingsForSite(int siteId, object status)` – returns the `DataSet` of shipping options on given site with specified status.
- `double CalculateShipping(object cartObj, string siteName)` – returns the shipping price for given `ShoppingCartInfo` object, in default currency.
- `DataSet GetShippingOptions(object cart, object status)` – returns the `DataSet` of shipping options with specified status and depending on the shopping cart data.
- `double ApplyShippingFreeLimit(double shipping, double totalPrice, double siteStoreFreeLimit)` –

Returns shipping price or zero according to site store shipping free limit.

8.20 CustomShoppingCartInfoProvider

This class provides methods for the shopping cart calculations. The methods internally work with **ShoppingCartInfo** object that stores and works with complete order information.

- `void EvaluateShoppingCartContent(object shoppingCart)` – evaluates the content in the given ShoppingCartInfo object. This method is required to fill at least both ShoppingCartContentTable and ShoppingCartTaxTable objects with proper data for shopping cart to work properly.
- `void EvaluateShoppingCartContent(object shoppingCart, bool evaluateForInvoice)` – evaluates the content in the given ShoppingCartInfo object. This method is required to fill at least both ShoppingCartContentTable and ShoppingCartTaxTable objects with proper data for generating an order invoice from them.
- `object GetShoppingCartInfo(int shoppingCartId)`– returns ShoppingCartInfo object with given ID.
- `object GetShoppingCartInfo(Guid shoppingCartGUID)`– returns ShoppingCartInfo object with given GUID.
- `object GetShoppingCartInfo(int userId, string siteName)` – returns ShoppingCartInfo object for the specified user and site.
- `object GetShoppingCartInfoFromOrder(int orderId)` – returns ShoppingCartInfo object created from the specified order.
- `void SetShoppingCartInfo(object shoppingCart)`– updates/inserts the shopping cart with data from given ShoppingCartInfo object.
- `void DeleteShoppingCartInfo(int shoppingCartId)`– deletes the shopping cart with given ID.
- `void DeleteShoppingCartInfo(Guid shoppingCartGuid)` – deletes the shopping cart with given GUID.
- `void DeleteShoppingCartInfo(int userId, string siteName)`– deletes the shopping cart of the specified user and site.
- `void DeleteShoppingCartItems(int cartId)` – deletes all the shopping cart items.
- `DataSet GetExpiredShoppingCarts()` – returns shopping carts that are older than specified time interval from now.
- `object CreateShoppingCartInfo(int siteId)` – returns new empty ShoppingCartInfo object.

- object `CreateShoppingCartInfo(DataRow dr)` – returns new `ShoppingCartInfo` object created from the given data row.
- object `CreateShoppingCartInfo(SerializationInfo info, StreamingContext context)` – returns new `ShoppingCartInfo` object created from deserialized data.
- void `ClearShoppingCartPrivateData(object shoppingCart)` – clears customer's private data from shopping cart.
- void `ActualizeSKUAvailableItems(object shoppingCart)` – actualizes products' available items according to the products' units of the specified shopping cart.
- **public static void `SetOrder(ShoppingCartInfo shoppingCart)`** – inserts or updates order according to the shopping cart data.

8.21 CustomShoppingCartItemInfoProvider

This class manages the shopping cart items. It uses the **ShoppingCartItemInfo** class.

- object `GetShoppingCartItemInfo(Guid cartItemGuid)` – returns `ShoppingCartItemInfo` object with given GUID.
- object `GetShoppingCartItemInfo(int cartItemId)` – returns `ShoppingCartItemInfo` object with given ID.
- void `DeleteShoppingCartItem(Guid cartItemGuid)` – deletes the shopping cart item with given GUID.
- void `DeleteShoppingCartItem(int cartItemId)` – deletes the shopping cart item with given ID.
- void `SetShoppingCartItemInfo(object cartItem)` – updates/inserts the shopping cart item with data from given `ShoppingCartItemInfo` object.
- void `SetShoppingCartItems(ArrayList cartItems)` – updates/inserts all the shopping cart items with data from given list items.
- `DataSet` `GetShoppingCartItems(int cartId)` – returns the `DataSet` of all shopping cart items including their SKU data of the specified shopping cart.
- `DataSet` `GetShoppingCartItemsFromOrder(int orderId)` – returns the `DataSet` of all shopping cart items including their SKU data of the specified order.
- `ArrayList` `GetShoppingCartItemList(int cartId)` – returns the list of the `ShoppingCartItemInfo` objects from the specified shopping cart.
- `ArrayList` `GetShoppingCartItemListFromOrder(int orderId)` – returns the list of the `ShoppingCartItemInfo` objects created from the order items of the specified order.

8.22 CustomSKUInfoProvider

This provider manages the products (SKUs). It uses the **SKUInfo** class.

- `object GetSKUInfo(int skuId)` – returns the SKUInfo object selected by given ID.
- `object GetSKUInfo(Guid skuGuid)` - returns the SKUInfo object selected by given GUID.
- `void SetSKUInfo(object sku)` – updates/inserts the SKU record from given SKUInfo object. If SKUID is set, updates, else inserts a new record.
- `void DeleteSKUInfo(int skuId)` – deletes specified SKU record.
- `bool CheckDependencies(int skuId)` – returns true if some objects depend on given SKU.
- `DataSet GetSKUs()` – returns the DataSet of all products. See database reference for detailed column information
- `DataSet GetSKUs(string where, string orderBy)` – returns DataSet of products selected with condition and order.
- `DataSet GetSKUs(bool products, bool productOptions, string where, string orderBy)` – returns DataSet of products and/or product options selected with condition and order.
- `DataSet GetSKUList(string where, string orderBy)` – returns the DataSet of product list. Result contains the SKU data and public and internal status display name.
- `DataSet GetTopNProductsBySales(int topN, int siteld, string where)` – returns the DataSet with top N products by sales for the specified site and according to the where condition.
- `void AddSKUToWishlist(int userId, int skuld, int siteld)` – adds specified SKU to user's wishlist.
- `void RemoveSKUFromWishlist(int userId, int skuld, int siteld)` – removes specified SKU from the wishlist of the given user.
- `bool IsSKUInWishlist(int userId, int skuld, int siteld)` – returns true if the given SKU is present in the user's wish list.
- `DataSet GetWishlist(int userId, int siteld)` - returns the content of wish list for the given user as a DataSet.
- `DataSet GetOptionCategorySKUs(int categoryId, string where)` – returns the DataSet of all product options from the specified product option category filtered by specified where condition.
- `void MoveSKUOptionUp(int skuld)` – moves specified product option up within the parent product option category.

- `void MoveSKUOptionDown(int skuld)`– moves specified product option down within the parent product option category.

Read also: [Using the Product datalist web part](#)

8.23 CustomSupplierInfoProvider

This class manages the supplier lookup table. It uses the **SupplierInfo** class.

- `object GetSupplierInfo(int supplierId)` – returns the **SupplierInfo** object with given ID.
- `object GetSupplierInfo(string supplierName)` – returns the **SupplierInfo** object with given name.
- `void SetSupplierInfo(object supplier)` – updates/inserts the supplier record from the given **SupplierInfo** object. If **SupplierID** is set, updates, else inserts a new record.
- `void DeleteSupplierInfo(int supplierId)` – deletes the supplier record.
- `DataSet GetAllSuppliers(object status)` – returns the **DataSet** of all the suppliers. See database reference for detailed column information.
- `object GetSupplierInfos(string where, string orderBy)` – returns the **DataSet** of all the suppliers filtered by where condition and ordered by orderBy expression, see the database reference for the supplier column definition.
- `bool CheckDependencies(int supplierId)` – returns true if some objects depend on given supplier ID.

8.24 CustomTaxClassInfoProvider

This class manages the tax classes. It uses the **TaxClassInfo** and **TaxClassCountryInfo** classes.

- `object GetTaxClassInfo(int taxClassId)` – returns the **TaxClassInfo** object with given ID.
- `object GetTaxClassInfo(string taxClassName)` – returns the **TaxClassInfo** object with given name.
- `void SetTaxClassInfo(object taxClass)` – updates/inserts the tax class record with data from given **TaxClassInfo** object. If **TaxClassID** is set, updates, else inserts a new record.
- `void DeleteTaxClassInfo(int taxClassId)` – deletes specified tax class record.

- `DataSet GetTaxClasses()` – returns the `DataSet` of all the tax classes. See database reference for detailed column information.
- `DataSet GetTaxClasses(string where, string orderBy)` – returns the `DataSet` of tax classes with selection condition and order.
- `void SetTaxClassCountryInfo(object taxClassCountry)` – updates/inserts the tax class country record. If IDs are set, updates, else inserts a new record.
- `void DeleteTaxClassCountryInfo(int taxClassCountryId, int taxClassId)` – deletes specified tax class country record.
- `object GetTaxClassCountryInfo(int taxClassCountryId, int taxClassId)` – returns the `TaxClassCountryInfo` object for given tax class and country.
- `DataSet GetTaxClassCountries(int taxClassId)` – returns the `DataSet` of all the countries assigned to the given tax class.
- `DataSet GetTaxClassesForCart(object cartInfo)` – returns the `DataSet` of all the classes used within the given `ShoppingCartInfo` object.
- `DataSet GetTaxClassesForCart(object cartInfo, string where)` – returns the `DataSet` of all the country tax classes used within the given `ShoppingCartInfo` object.
- `void AddTaxClassToSKU(int taxClassId, int skuId)` – assigns the given tax class to the specified product.
- `void RemoveTaxClassFromSKU(int taxClassId, int skuId)` – removes the tax class binding from the specified product.
- `bool IsTaxClassAssignedToSKU(int taxClassId, int skuId)` – returns true if the product is assigned for the given tax class.
- `DataSet GetSKUTaxClasses(int skuId)` – returns the `DataSet` of tax classes assigned to given product.
- `void SetTaxClassStateInfo(object taxClassState)` - saves the information about assignment of the state to the tax class.
- `void DeleteTaxClassStateInfo(int stateId, int taxClassId)` - removes the state from the given tax class.
- `DataSet GetTaxClassStates(int taxClassId, int countryId)` - returns `DataSet` with states of the given country assigned to the given tax class.
- `DataSet GetStateTaxClassesForCart(object cartInfo)` – returns the `DataSet` of all the state tax classes used within the given `ShoppingCartInfo` object.
- `DataSet GetStateTaxClassesForCart(object cartInfo, string where)` - returns the `DataSet` of all the state tax classes used within the given `ShoppingCartInfo` object.

- `DataSet GetAllCountriesWithStates()` - returns the `DataSet` of all the countries which have some states.

8.25 CustomVolumeDiscountInfoProvider

This class manages the volume discounts for particular products.

- `object DeleteVolumeDiscountInfo(int volumeDiscountId)` - deletes the `TaxClassInfo` object with given ID.
- `void DeleteVolumeDiscounts(int SKUId)` - deletes all volume discounts for the given SKU (product).
- `object GetVolumeDiscountInfo(int volumeDiscountId)` - returns volume discount.
- `object GetVolumeDiscountInfo(int SKUId, int units)` - returns volume discount object for given SKU (product) and given quantity of the product.
- `DataSet GetVolumeDiscounts(int SKUId)` - returns `DataSet` with all volume discounts for the given SKU (product).
- `void SetVolumeDiscountInfo(object volumeDiscount)` - saves the volume discount to the database.
- `object GetVolumeDiscounts(string where, string orderBy)` - returns the `DataSet` of all the volume discounts filtered by where condition and ordered by orderBy expression, see the database reference for the volume discount column definition.

8.26 Using the Product datalist web part

If you're using a custom provider for managing product information (using the **CustomSKUInfoProvider**), you will need to use the **Product datalist** web part or develop a similar web part that will display the products using the custom provider.

You can find more details on the **Product datalist** web part in **Kentico CMS Web Parts and Controls Reference/Web Parts/E-commerce/Product datalist**.

Part

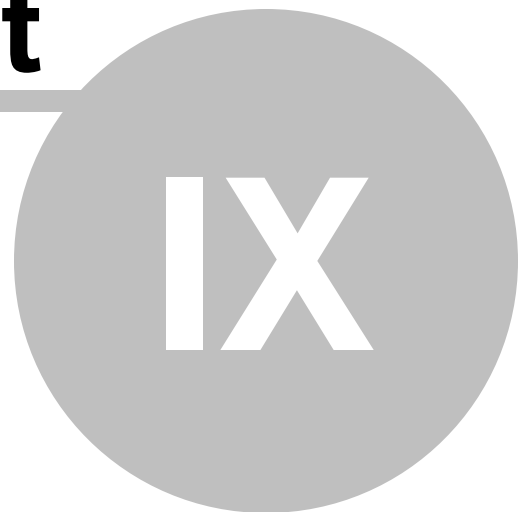
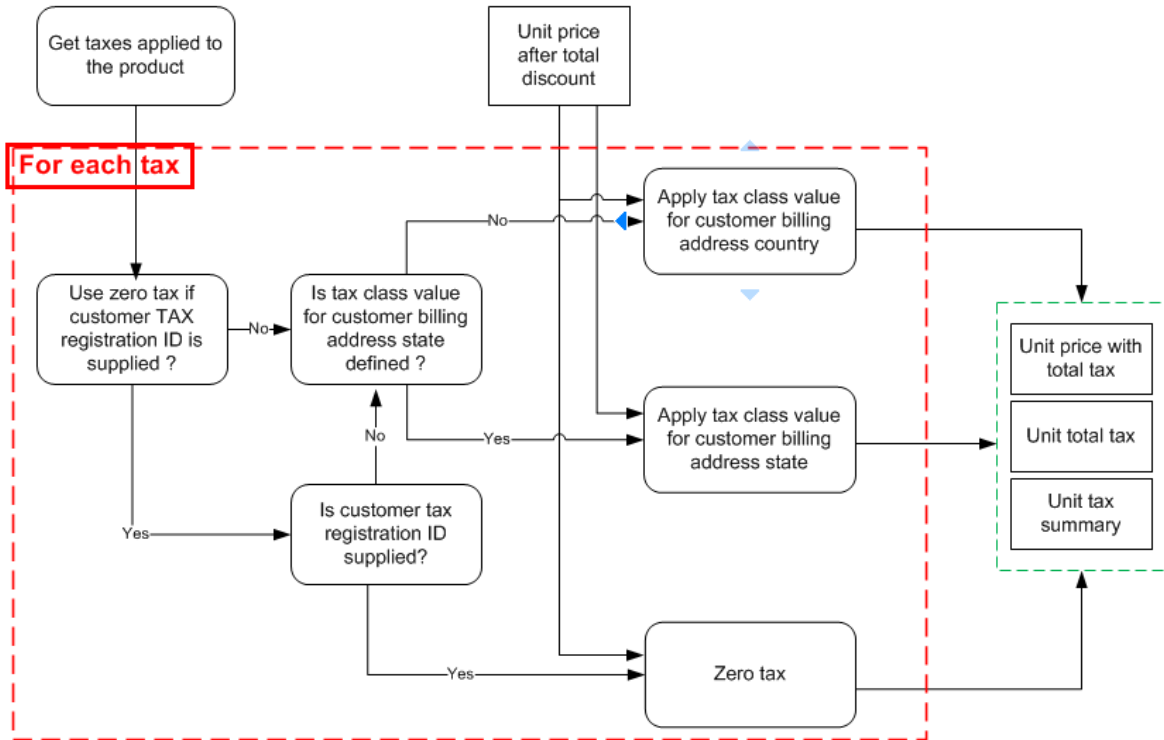

Figure A: Tax calculation process

9 Figure A: Tax calculation process

The following figure shows how the tax is calculated:

Taxes



Part

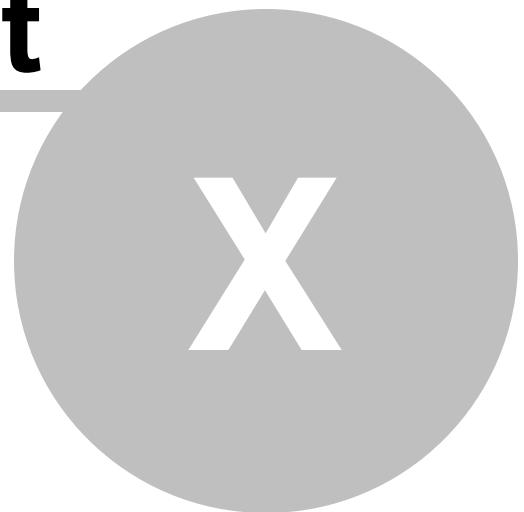
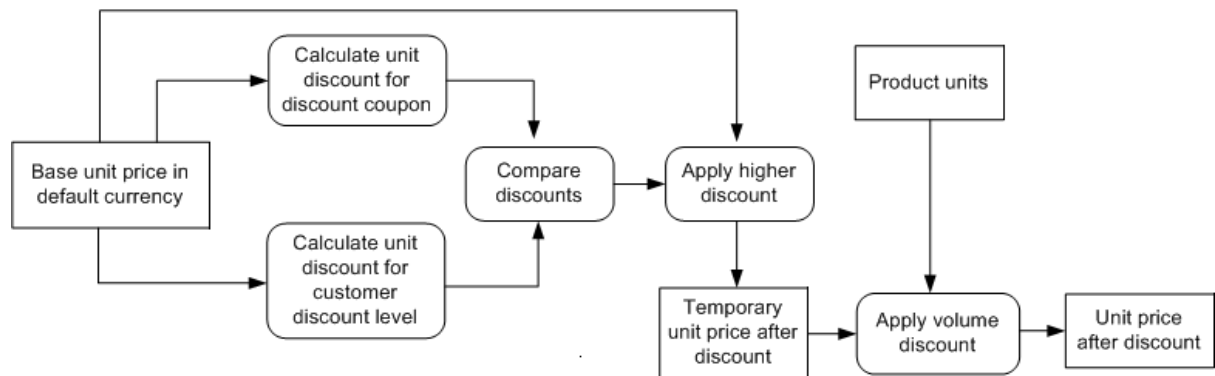

Figure B: Discount calculation

10 Figure B: Discount calculation

The following figure shows how discounts are calculated:

Discounts



Part

XI

Figure C: Shopping cart price calculation

11 Figure C: Shopping cart price calculation

The following figure shows how the total price is calculated:

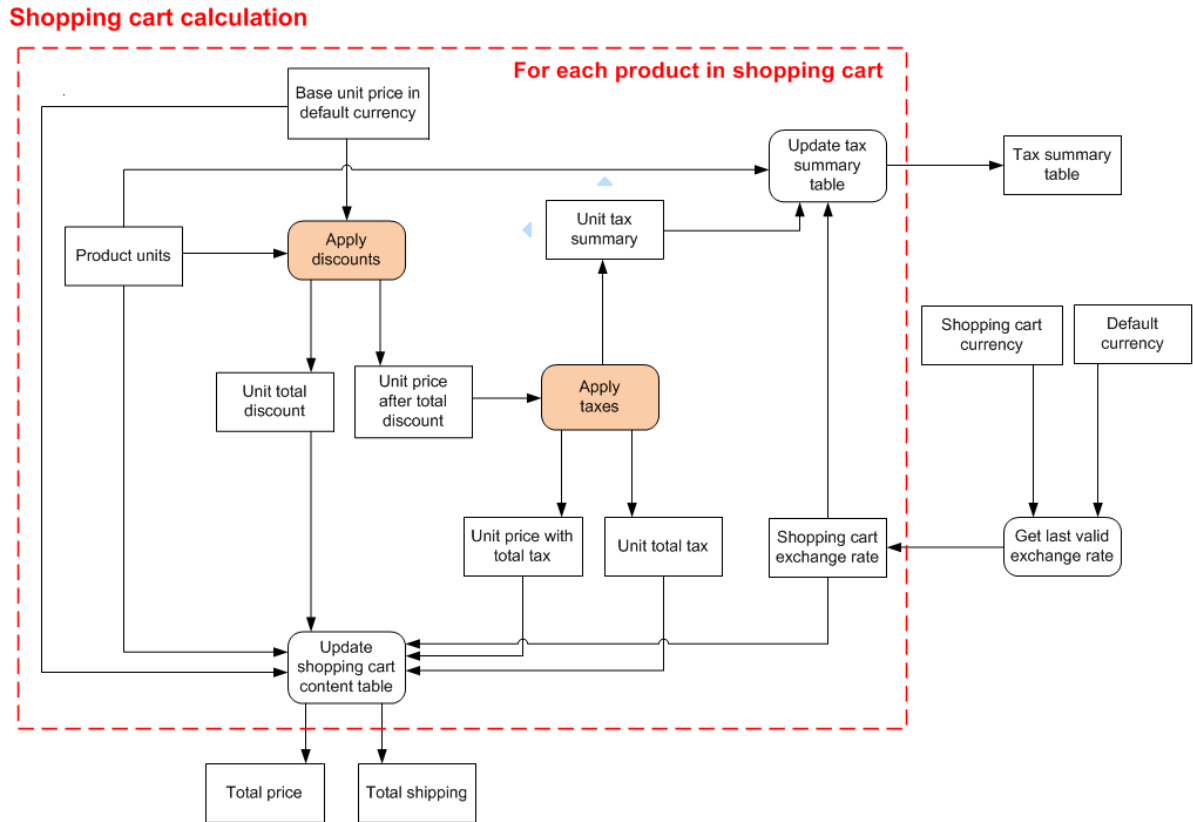

Part

XIII

Figure D - Shopping cart retrieval

12 Figure D - Shopping cart retrieval

The following figure shows how the shopping cart is retrieved for the current visitor:

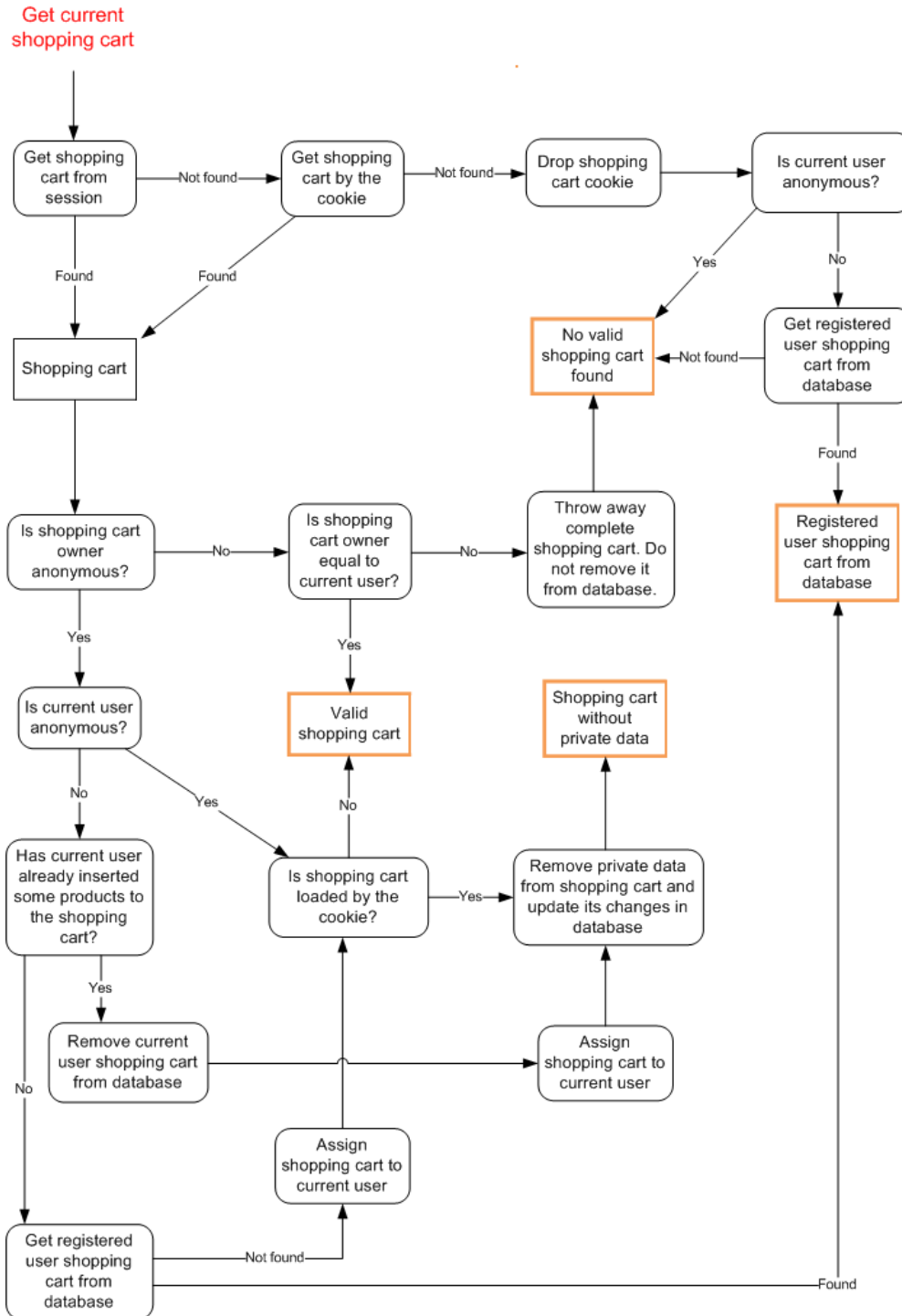

Index

- A -

- Adding items to the shopping cart 125
- Adding items to the wish list 130

- C -

- Company details
 - changing 40
- Configuration settings
 - countries and states 159
 - currencies 152
 - customers 138
 - customizing an e-mail template 166
 - customizing invoice template 166
 - deleting old shopping carts 188
 - departments 150
 - discount coupons 147
 - discount levels 147
 - discounts overview 178
 - enabling the e-commerce module 156
 - exchange rates 153
 - internal status 154
 - invoice 154
 - localization 163
 - manufacturers 146
 - mapping document fields 160
 - multi-site configuration 159
 - order status 153
 - orders 137
 - overview 136
 - payment methods 150
 - product options 146
 - products 142
 - public status 153
 - reports 148
 - security 158
 - shipping options 150
 - sitemanager settings 161
 - store 148
 - suppliers 147
 - tax classes 152
 - using product inventory 172

- web.config settings 161
- Custom providers
 - CustomAddressInfoProvider 220
 - CustomCurrencyInfoProvider 221
 - CustomCustomerInfoProvider 222
 - CustomDepartmentInfoProvider 223
 - CustomDiscountCouponInfoProvider 224
 - CustomDiscountLevelInfoProvider 225
 - CustomExchangeTableInfoProvider 225
 - CustomInternalStatusInfoProvider 226
 - CustomManufacturerInfoProvider 227
 - CustomOptionCategoryInfoProvider 227
 - CustomOrderInfoProvider 228
 - CustomOrderItemInfoProvider 230
 - CustomOrderStatusInfoProvider 230
 - CustomOrderStatusUserInfoProvider 231
 - CustomPaymentOptionInfoProvider 231
 - CustomPublicStatusInfoProvider 232
 - CustomShippingOptionInfoProvider 233
 - CustomShoppingCartInfoProvider 234
 - CustomShoppingCartItemInfoProvider 235
 - CustomSKUInfoProvider 236
 - CustomSupplierInfoProvider 237
 - CustomTaxClassInfoProvider 237
 - CustomVolumeDiscountInfoProvider 239
- overview 218
- Product datalist web part 239
- using 219

- D -

- Discount calculation 243

- F -

- First purchase 9

- I -

- Images
 - displaying 99
 - overview 99
 - resizing 104
 - storing 102
- Integration with existing site
 - overview 80

- O -

Overview 7

- P -

Product

- adding new 16
- adding product options 20
- adding to multiple categories 29
- customizing product categories 25
- displaying featured products 33
- sorting and paging 36

Product datalist web part 239

Product fields

- adding custom fields 64
- adding images 56
- customizing product design 53
- defining new product type 46

Product price

- displaying 131

Product URL

- getting 132

Purchasing and payment

- Authorize.NET configuration 201
- custom checkout dialogs 195
- custom payment gateways 206
- customer credit 215
- customizing 191
- overview 190
- payment gateways 201
- payment results 213
- PayPal configuration 203

- S -

Searching 133

Shopping cart price calculation 245

Shopping cart retrieval 247

- T -

Tax calculation process 241

Tools

- BizForms 109
- Blogs 110

Booking system 110

Content staging 111

Event calendar 112

File import 113

Forums 114

GeoMapping 116

Image gallery 117

Messaging 118

Newsletters 119

overview 108

Polls 120

Reporting 121

RSS feeds 122

User contributions 122

Web analytics 123

Web farm synchronization 124

- W -

Web design

- colors using CSS styles 77
- customizing master page 68

Web parts

- my account 81
- random products 83
- shopping cart 89
- shopping cart preview 91
- similar products by sale 93
- top N products by sale 95
- wishlist 97